

Free Mount Cylinder

CU Series

A space-saving air cylinder with multiple surfaces capable of mounting directly. Offered in rich variations.



Space-saving

The multiple surface direct mounting with a square body and no brackets allows the freedom of the mounting surface. This enables space-saving designs for equipment.

Mounting

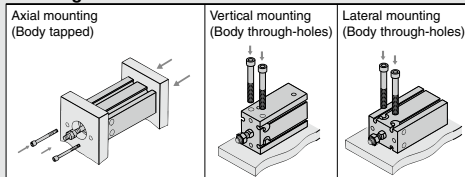

Series Variations

Series	Action	Rod	Bore size (mm)	Page	
Standard CU Series	Double acting	Single rod	6, 10, 16, 20, 25, 32	727	
	Single acting	Double rod		734	
Non-rotating CUK Series	Double acting	Single rod		739	
	Single acting	Double rod		746	
Long stroke CU Series	Double acting	Single rod		750	
	Double acting	Single rod		754	
Long stroke, Non-rotating rod CUK Series	Double acting	Single rod		760	
	Double acting	Single rod		764	
With air cushion CU-A Series	Double acting	Single rod		20, 25, 32	768
For vacuum ZCUK Series	Double acting	Single rod		10, 16, 20, 25, 32	777

Combinations of Standard Products and Made

CU Series

●: Standard
⊙: Made to Order specifications
○: Special product (Contact SMC for details.)
—: Not available

Series	CU (Standard)			CUK (Non-rotating)		
	Double acting		Single acting	Double acting		Single acting
	Single rod	Double rod	Single rod	Single rod	Double rod	Single rod

Symbol	Specification	Applicable bore size	ø6 to ø32					
Standard	Standard	ø6 to ø32	●	●	●	●	●	●
D	Built-in magnet		●	●	●	●	●	●
10-, 11-, 21-, 22-	Clean series	ø6 to ø25	●	—	—	—	—	—
25A-	Copper (Cu) and zinc (Zn)-free ^{Note 3)}	ø10 to ø32	●	○	○	●	○	○
20-	Copper ^{Note 2)} and Fluorine-free	ø6 to ø32	●	○	○	●	○	○
XB6	Heat-resistant cylinder (–10 to 150 °C)	ø6 to ø32	⊙	○	—	⊙	○	—
XB7	Cold-resistant cylinder (–40 to 70 °C)		⊙	○	—	⊙	○	—
XB9	Low-speed cylinder (10 to 50 mm/s) ^{Note 1)}		⊙	○	—	⊙	○	—
XB13	Low-speed cylinder (5 to 50 mm/s) ^{Note 1)}		⊙	○	—	⊙	○	—
XC19	Intermediate stroke (5 mm spacer)		⊙	○	—	⊙	○	—
XC22	Fluororubber seals		⊙	○	⊙	⊙	○	⊙
XC34	Rod not extending beyond non-rotating plate		—	—	—	⊙	○	⊙

Note 1) Refer to the **Web Catalog** for low-speed cylinders.

Note 2) Copper-free for the externally exposed part. For details, refer to the **Web Catalog**.

Note 3) For details, refer to the SMC website.

to Order Specifications

CU Series

CU (Long stroke)		CUK (Long stroke, Non-rotating)		CU-A (Air cushion)	ZCUK (For vacuum)	CUX (Low-speed cylinder) <small>(Note)</small>	
Double acting		Double acting		Double acting	Double acting	Double acting	
Single rod	Double rod	Single rod	Double rod	Single rod	Single rod	Single rod	
ø6 to ø32				ø20 to ø32	ø10 to ø32		
●	●	●	●	●	●	●	
●	●	●	●	●	●	●	
—	—	—	—	—	—	○ (ø16 or more)	
●	○	●	○	○	○	—	
●	○	●	○	○	○	—	
◎	○	◎	○	—	○	—	
◎	○	◎	○	—	○	—	
◎	○	◎	○	—	○	—	
◎	○	◎	○	—	○	—	
◎	○	◎	○	—	○	○	
◎	○	◎	○	—	○	—	
—	—	◎	○	—	○	—	

Precautions on Free Mount

1. Operating speed

Make sure to connect a speed controller to the cylinder and adjust its speed to 500 mm/s or less.

If a load is to be attached to the end of the rod, adjust the speed to the maximum speed shown in Graph (1) or less, in accordance with the added mass.

Graph (1) Load Mass and Maximum Speed

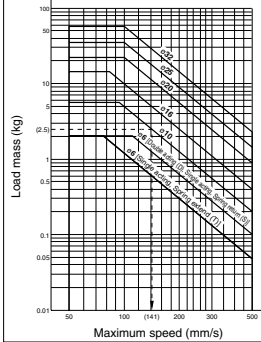

How to read the graph

- Using the CU10 to drive a load weighing 2.5 kg: From the vertical axis in the graph on the left, extend the horizontally from 2.5 kg., and drop down from the point at which it intersects with the tube bore $\phi 10$. The maximum speed will be 141 mm/s.

2. Rod end allowable lateral load

Make sure that the lateral load that is applied to the rod end will be no more than the values shown in the tables.

The tables show the value for a single rod. For double rods, please contact SMC.

Standard Double Acting, Single Rod

Without auto switch: CU□-□D

Model	Stroke (mm)												
	5	10	15	20	25	30	40	50	60	70	80	90	100
CU6	0.085	0.075	0.068	0.061	0.056	0.052	0.045	0.039	0.035	—	—	—	—
CU10	0.34	0.30	0.27	0.25	0.23	0.21	0.18	0.16	0.15	—	—	—	—
CU16	0.69	0.61	0.55	0.50	0.46	0.43	0.37	0.33	0.29	—	—	—	—
CU20	2.2	2.0	1.8	1.6	1.5	1.4	1.2	1.1	1.0	0.92	0.85	0.78	0.73
CU25	3.5	3.2	3.0	2.7	2.6	2.4	2.1	1.9	1.7	1.6	1.4	1.3	1.2
CU32	5.4	4.9	4.6	4.3	4.0	3.8	3.3	3.0	2.8	2.5	2.3	2.2	2.0

With auto switch: CDU□-□D

Model	Stroke (mm)												
	5	10	15	20	25	30	40	50	60	70	80	90	100
CDU6	0.085	0.075	0.068	0.061	0.056	0.052	0.045	0.039	0.035	—	—	—	—
CDU10	0.30	0.27	0.25	0.23	0.21	0.20	0.17	0.15	0.14	—	—	—	—
CDU16	0.99	0.89	0.81	0.74	0.69	0.64	0.56	0.50	0.45	—	—	—	—
CDU20	3.0	2.7	2.5	2.3	2.1	2.0	1.8	1.6	1.4	1.3	1.2	1.1	1.0
CDU25	4.7	4.3	4.0	3.7	3.5	3.2	2.9	2.6	2.4	2.2	2.0	1.9	1.7
CDU32	7.1	6.6	6.1	5.7	5.4	5.1	4.6	4.1	3.8	3.5	3.2	3.0	2.8

Non-rotating Rod Type

Without auto switch: CUK□-□D

Model	Stroke (mm)												
	5	10	15	20	25	30	40	50	60	70	80	90	100
CUK6	0.075	0.068	0.061	0.056	0.052	0.048	0.042	0.037	0.033	—	—	—	—
CUK10	0.30	0.27	0.25	0.23	0.21	0.20	0.17	0.15	0.14	—	—	—	—
CUK16	0.55	0.50	0.46	0.43	0.40	0.37	0.33	0.29	0.26	—	—	—	—
CUK20	1.8	1.6	1.5	1.4	1.3	1.2	1.1	1.0	0.92	0.85	0.78	0.73	0.68
CUK25	3.0	2.7	2.6	2.4	2.2	2.1	1.9	1.7	1.6	1.4	1.3	1.2	1.2
CUK32	4.3	4.0	3.8	3.5	3.3	3.2	2.9	2.6	2.4	2.2	2.1	2.0	1.8

With auto switch: CDUK□-□D

Model	Stroke (mm)												
	5	10	15	20	25	30	40	50	60	70	80	90	100
CDUK6	0.075	0.068	0.061	0.056	0.052	0.048	0.042	0.037	0.033	—	—	—	—
CDUK10	0.30	0.27	0.25	0.23	0.21	0.20	0.17	0.15	0.14	—	—	—	—
CDUK16	0.81	0.74	0.69	0.64	0.60	0.56	0.50	0.45	0.41	—	—	—	—
CDUK20	2.5	2.3	2.1	2.0	1.9	1.8	1.6	1.4	1.3	1.2	1.1	1.0	1.0
CDUK25	4.0	3.7	3.5	3.2	3.1	2.9	2.6	2.4	2.2	2.0	1.9	1.7	1.6
CDUK32	5.7	5.4	5.1	4.8	4.6	4.4	4.0	3.6	3.4	3.1	2.9	2.7	2.6

Single Acting, Spring Return (S)

Without auto switch: CU□-□S (N)

Model	Stroke (mm)		
	5	10	15
CU6	0.19	0.17	0.15
CU10	0.66	0.59	0.60
CU16	1.4	1.3	1.3
CU20	4.7	4.2	4.4
CU25	6.8	6.2	6.5
CU32	10	9.8	10

Single Acting, Spring Extend (T)

Without auto switch: CU□-□T (N)

Model	Stroke (mm)		
	5	10	15
CU6	0.067	0.059	0.052
CU10	0.29	0.26	0.24
CU16	0.99	0.89	0.81
CU20	2.2	2.0	1.8
CU25	3.5	3.2	3.0
CU32	5.4	4.9	4.6

With auto switch: CDU□-□S (N)

Model	Stroke (mm)		
	5	10	15
CDU6	0.17	0.15	0.13
CDU10	0.66	0.59	0.60
CDU16	1.6	1.5	1.5
CDU20	5.3	4.8	4.9
CDU25	7.6	7.0	7.2
CDU32	12	11	11

With auto switch: CDU□-□T (N)

Model	Stroke (mm)		
	5	10	15
CDU6	0.062	0.055	0.049
CDU10	0.29	0.26	0.24
CDU16	0.99	0.89	0.81
CDU20	3.0	2.7	2.5
CDU25	4.7	4.3	4.0
CDU32	7.1	6.6	6.1

Non-rotating Rod Type

Single Acting, Spring Return (S)

Without auto switch: CUK□-□S (N)

Model	Stroke (mm)		
	5	10	15
CUK6	0.17	0.15	0.14
CUK10	0.59	0.54	0.56
CUK16	1.1	1.0	1.1
CUK20	3.9	3.6	3.8
CUK25	5.7	5.3	5.7
CUK32	8.5	7.9	8.6

Non-rotating Rod Type

Single Acting, Spring Extend (T)

Without auto switch: CUK□-□T (N)

Model	Stroke (mm)		
	5	10	15
CUK6	0.059	0.052	0.047
CUK10	0.26	0.24	0.22
CUK16	0.81	0.74	0.69
CUK20	1.8	1.6	1.5
CUK25	3.0	2.7	2.6
CUK32	4.3	4.0	3.8

Free Mount Cylinder Double Acting, Single Rod

CU Series

ø6, ø10, ø16, ø20, ø25, ø32

How to Order

CU 6 [] - 30 D - []

With auto switch CDU 6 [] - 30 D - M9BW [] - []

Built-in magnet

Bore size

6	6 mm
10	10 mm
16	16 mm
20	20 mm
25	25 mm
32	32 mm

Port thread type

Symbol	Type	Bore size
Nil	M5 x 0.8	ø6, ø10, ø16, ø20, ø25
	Rc 1/8	ø32
TN	NPT 1/8	ø32
TF	G 1/8	ø32

Action

D	Double acting
---	---------------

Standard stroke (mm)

ø6, ø10, ø16	5, 10, 15, 20, 25, 30
ø20, ø25, ø32	5, 10, 15, 20, 25, 30, 40, 50

Auto switch

Nil	Without auto switch
-----	---------------------

Number of auto switches

Nil	2 pcs.
S	1 pc.

Made to Order
* Refer to page 728 for the Made to Order specifications.

Built-in Magnet Cylinder Model
If a built-in magnet cylinder without an auto switch is required, there is no need to enter the symbol for the auto switch.
(Example): CDU20-25D

Applicable Auto Switches/Refer to pages 1271 to 1365 for further information on auto switches.

Type	Special function	Electrical entry	Indicator light	Wiring (Output)	Load voltage		Auto switch model		Lead wire length (m)					Pre-wired connector	Applicable load	
					DC	AC	Perpendicular	In-line	0.5 (Nil)	1 (M)	3 (L)	5 (Z)	IC circuit		Relay, PLC	
Solid state auto switch	—	Grommet	Yes	3-wire (NPN)	5 V, 12 V	—	M9NV	M9N	●	●	●	○	○	○	Relay, PLC	
				3-wire (PNP)			M9PV	M9P	●	●	○	○	○			
				2-wire	M9BV		M9B	●	●	●	○	○	○			
	3-wire (NPN)			5 V, 12 V	M9NWX		M9NW	●	●	○	○	○	○			
	3-wire (PNP)				M9PWX		M9PW	●	●	○	○	○	○			
	2-wire			12 V	M9BWX		M9BW	●	●	○	○	○	○			
3-wire (NPN)		M9NAV ^{*1}	M9NA ^{*1}		○	○	●	○	○	○	○					
Reed auto switch	—	Grommet	Yes	3-wire (NPN equivalent)	—	5 V	—	A96V	A96	●	—	●	—	—	IC circuit	—
				2-wire				24 V	12 V	100 V	A93V ^{*2}	A93	●	●	●	
				No	100 V or less	A90V	A90	●	—	●	—	—	—	IC circuit		

- *1 Water resistant type auto switches can be mounted on the above models, but in such case SMC cannot guarantee water resistance. Consult with SMC regarding water resistant types with the above model numbers.
- *2 1 m type lead wire is only applicable to D-A93.
- * Lead wire length symbols: 0.5 m Nil (Example) M9NW
1 m M (Example) M9NWM
3 m L (Example) M9NWL
5 m Z (Example) M9NWX
- * Solid state auto switches marked with "○" are produced upon receipt of order.
- * Since there are applicable auto switches other than the above, refer to page 782 for details.
- * For detail about auto switches with pre-wired connector, refer to pages 1340 and 1341.
- * Auto switches are shipped together but not assembled.

CU Series

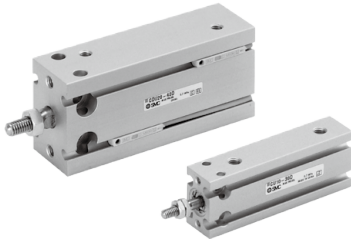

Symbol

Double acting, Single rod, Rubber bumper

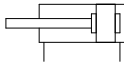

Made to Order Specifications

[Click here for details](#)

Symbol	Specifications
-XB6	Heat resistant (-10 to 150°C)
-XB7	Cold resistant (-40 to 70°C)
-XB9	Low speed (10 to 50 mm/s)
-XB13	Low speed (5 to 50 mm/s)
-XC19	Intermediate stroke (5 mm spacer)
-XC22	Fluororubber seals

For clean room specifications, refer to the [Web Catalog](#).

Tightening Torque/

When mounting the CU series, refer to the below table.

Bore size (mm)	Hexagon socket head cap screw dia.	Proper tightening torque (N·m)
6, 10	M3	1.08 ±10%
16	M4	2.45 ±10%
20, 25	M5	5.10 ±10%
32	M6	8.04 ±10%

Moisture Control Tube IDK Series



When operating an actuator with a small diameter and a short stroke at a high frequency, the dew condensation (water droplet) may occur inside the piping depending on the conditions.

Simply connecting the moisture control tube to the actuator will prevent dew condensation from occurring. For details, refer to the [Web Catalog](#).

Specifications

Bore size (mm)	6	10	16	20	25	32
Fluid	Air					
Proof pressure	1.05 MPa					
Maximum operating pressure	0.7 MPa					
Minimum operating pressure	0.12 MPa	0.06 MPa	0.05 MPa			
Ambient and fluid temperature	Without auto switch: -10 to 70°C (No freezing) With auto switch: -10 to 60°C (No freezing)					
Lubrication	Non-lube					
Piston speed	50 to 500 mm/s					
Cushion	Rubber bumper					
Rod end thread	Male thread					
Stroke length tolerance	+1.0 0 mm					

Standard Stroke

Bore size (mm)	Standard stroke (mm)
6, 10, 16	5, 10, 15, 20, 25, 30
20, 25, 32	5, 10, 15, 20, 25, 30, 40, 50

For "Long Stroke", refer to page 760.

Theoretical Output

(N)

Bore size (mm)	Rod size (mm)	Operating direction	Piston area (mm ²)	Operating pressure (MPa)			
				0.3	0.5	0.7	
6	3	OUT	28.3	8.49	14.2	19.8	
		IN	21.2	6.36	10.6	14.8	
10	4	OUT	78.5	23.6	39.3	55.0	
		IN	66.0	19.8	33.0	46.2	
16	6	OUT	201	60.3	101	141	
		IN	172	51.6	86.0	121	
20	8	OUT	314	94.2	157	220	
		IN	264	79.2	132	185	
25	10	OUT	491	147	246	344	
		IN	412	124	206	288	
32	12	OUT	804	241	402	563	
		IN	691	207	346	454	

Weight/() Denotes the values with D-A93.

(g)

Model	Cylinder stroke (mm)							
	5	10	15	20	25	30	40	50
C(D)U6-□D	22 (27)	25 (35)	28 (38)	31 (41)	34 (44)	37 (47)	—	—
C(D)U10-□D	36 (41)	40 (50)	44 (54)	48 (58)	52 (62)	56 (66)	—	—
C(D)U16-□D	50 (75)	56 (86)	62 (92)	68 (98)	74 (104)	80 (110)	—	—
C(D)U20-□D	95 (128)	106 (143)	117 (154)	128 (165)	139 (176)	150 (187)	172 (209)	194 (231)
C(D)U25-□D	176 (230)	193 (252)	210 (269)	227 (286)	244 (303)	261 (320)	295 (354)	329 (388)
C(D)U32-□D	262 (335)	286 (364)	310 (388)	334 (412)	358 (436)	382 (460)	430 (508)	478 (556)

* For the auto switch weight, refer to page 1271.

Low-speed Cylinder

CU X **Mounting bracket** **Bore size** — **Stroke**

↓ Low-speed Cylinder

Smooth operation with a little sticking and slipping at low speed.
Can start smoothly with a little ejection even after being rendered for hours.

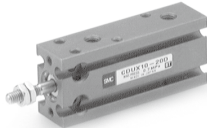

Specifications

Bore size (mm)	10	16	20	25	32
Fluid	Air				
Proof pressure	1.05 MPa				
Max. operating pressure	0.7 MPa				
Ambient and fluid temperature	Without auto switch: -10 to 70°C (No freezing) With auto switch: -10 to 60°C (No freezing)				
Lubricant	Not applicable (Non-lube)				
Piston speed	ø10, ø16: 1 to 300 mm/s ø20 to ø32: 0.5 to 300 mm/s				
Cushion	Rubber bumper on both ends				
Rod end thread	Male thread				
Stroke length tolerance	+10 0				

Minimum Operating Pressure

Bore size (mm)	10	16	20	25	32
Minimum Operating Pressure (MPa)	0.06	0.06	0.05	0.05	0.05

The dimensions are the same as the double acting, single rod type.
Refer to the **Web Catalog** for details.

Construction

ø6

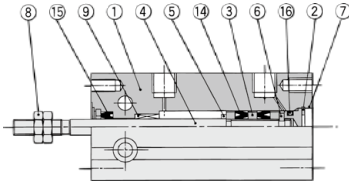

ø10

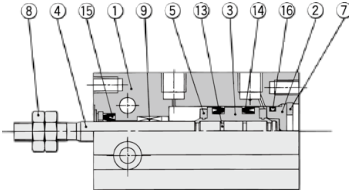

ø16 to ø32

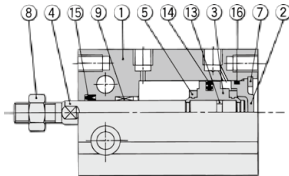

With auto switch

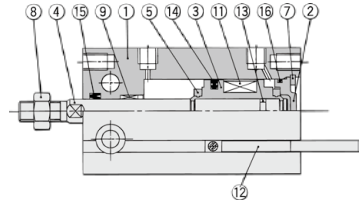
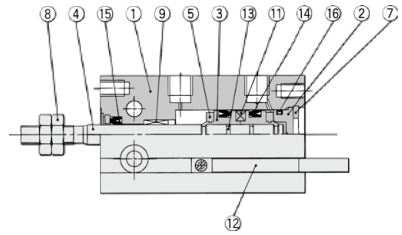
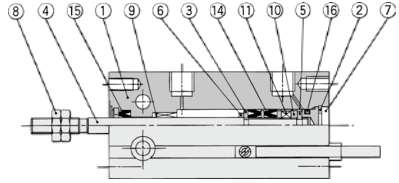

Component Parts

No.	Description	Material	Note
1	Cylinder tube	Aluminum alloy	Hard anodized
2	Head cover	Brass	ø6 to ø10, Electroless nickel plated
		Aluminum alloy	ø16 to ø32, Chromated
3	Piston	Brass	ø6
		Aluminum alloy	ø10 to ø32, Chromated
4	Piston rod	Stainless steel	
5	Bumper A	Urethane	
6	Bumper B	Urethane	
7	Retaining ring	Carbon tool steel	Phosphate coated

Component Parts

No.	Description	Material	Note
8	Rod end nut	Carbon steel	Chromated
9	Bushing	Bearing alloy	
10	Magnet holder	Brass	ø6
11	Magnet	—	
12	Auto switch	—	
13	Piston gasket		
14*	Piston seal	NBR	
15*	Rod seal		
16*	Gasket		

Replacement Parts: Seal Kit

Bore size (mm)	Kit no.	Contents
10	CU10D-PS	Set of nos. above 13, 15, 16
16	CU16D-PS	
20	CU20D-PS	
25	CU25D-PS	
32	CU32D-PS	

* Seal kit includes 13, 15, 16. Order the seal kit, based on each bore size.

* Seal kit includes a grease pack (10 g).

Order with the following part number when only the grease pack is needed.

Grease pack part number: GR-S-010 (10 g)

Dimensions: Double Acting, Single Rod

ø6, ø10

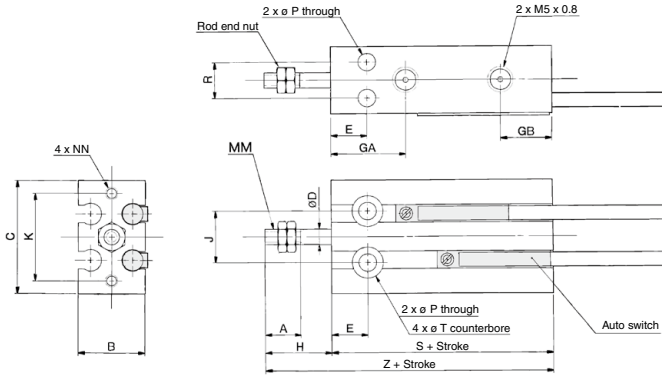

ø16 to ø32

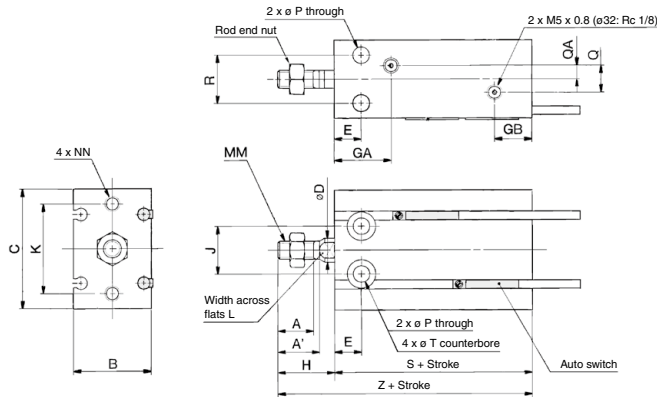

Rod End Nut/Accessory

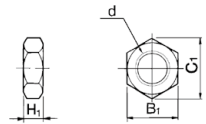

Material: Carbon steel

Part no.	Applicable bore size (mm)	d	H ₁	B ₁	C ₁
NTP-006	6	M3 x 0.5	1.8	5.5	6.4
NTP-010	10	M4 x 0.7	2.4	7	8.1
NTJ-015C	16	M5 x 0.8	4	8	9.2
NT-015A	20	M6 x 1.0	5	10	11.5
NT-02	25	M8 x 1.25	5	13	15.0
NT-03	32	M10 x 1.25	6	17	19.6

Bore size (mm)	A	A'	B	C	D	E	GA	GB	H	J	K	L	MM	NN	P	Q	QA
	6	7	—	13	22	3	7	15	10	13	10	17	—	M3 x 0.5	M3 x 0.5 depth 5	3.2	—
10	10	—	15	24	4	7	16.5	10	16	11	18	—	M4 x 0.7	M3 x 0.5 depth 5	3.2	—	—
16	11	12.5	20	32	6	7	16.5 ^(max)	11.5	16	14	25	5	M5 x 0.8	M4 x 0.7 depth 6	4.5	4	2
20	12	14	26	40	8	9	19	12.5	19	16	30	6	M6 x 1.0	M5 x 0.8 depth 8	5.5	9	4.5
25	15.5	18	32	50	10	10	21.5	13	23	20	38	8	M8 x 1.25	M5 x 0.8 depth 8	5.5	9	4.5
32	19.5	22	40	62	12	11	23	12.5	27	24	48	10	M10 x 1.25	M6 x 1.0 depth 9	6.6	13.5	4.5

Note) 5 stroke (CU16-5D): 14.5 mm

Bore size (mm)	R	T	Without auto switch		With auto switch	
			S	Z	S	Z
6	7	6 depth 4.8	33	46	33	46
10	9	6 depth 5	36	52	36	52
16	12	7.6 depth 6.5	30	46	40	56
20	16	9.3 depth 8	36	55	46	65
25	20	9.3 depth 9	40	63	50	73
32	24	11 depth 11.5	42	69	52	79

Auto Switch Mounting

Proper Auto Switch Mounting Position (Detection at stroke end) and Its Mounting Height

D-A9□
D-M9□
D-M9□W
D-M9□A

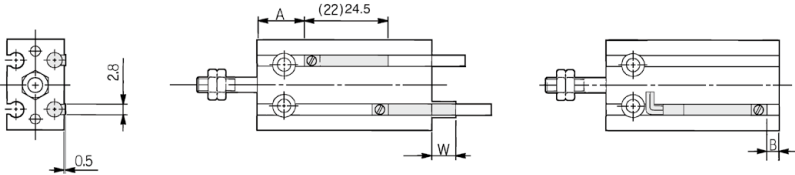

() : Denotes the values of D-A96.

D-A9□V
D-M9□V
D-M9□WV
D-M9□AV

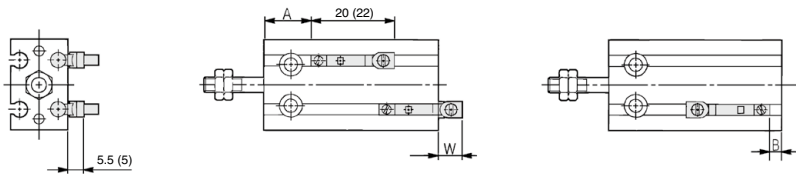

() : Denotes the values of D-A9□V.

Bore size (mm)	D-A9□, D-A9□V			D-M9□, D-M9□W			D-M9□V, D-M9□WV			D-M9□A			D-M9□AV		
	A	B	W	A	B	W	A	B	W	A	B	W	A	B	W
6	13.5	-0.5	2.5 (5)	17.5	3.5	6.5	17.5	3.5	4.5	17.5	3.5	8.5	17.5	3.5	6.5
10	12.5	3.5	-1.5 (1)	16.5	7.5	2.5	16.5	7.5	0.5	16.5	7.5	4.5	16.5	7.5	2.5
16	16	4	-2 (0.5)	20	8	1.5	20	8	-0.5	20	8	3.5	20	8	1.5
20	20	6	-4 (-1.5)	24	10	0	24	10	-2	24	10	2	24	10	0
25	22.5	7	-5.5 (-3)	26.5	11	-1.5	26.5	11	-3.5	26.5	11	0.5	26.5	11	-1.5
32	23.5	8.5	-6.5 (-4)	27.5	12.5	-2.5	27.5	12.5	-4.5	27.5	12.5	-0.5	27.5	12.5	-2.5

Note 1) Figures in the table above are used as a reference when mounting the auto switches for stroke end detection. In the case of actually setting the auto switches, adjust them after confirming their operation.

Note 2) Negative figures in the table W indicate an auto switch is mounted inward from the edge of the cylinder body.

Note 3) In the case of the 5 stroke or the 10 stroke, there are times in which the auto switch will not turn OFF or 2 auto switches will turn ON simultaneously due to their movement range. Therefore, set the position approximately 1 to 4 mm outward from the values given in the table above. Then, perform an operation inspection to make sure that the auto switches operate normally (if 1 switch is used, make sure that it turns ON and OFF properly; if 2 auto switches are used, make sure that both auto switches turn ON).

Note 4) () in column W is the dimensions of D-A90 and A93.

Operating Range

Auto switch model	Bore size (mm)					
	6	10	16	20	25	32
D-A9□, A9□V	5	6	9	11	12.5	14
D-M9□, M9□V						
D-M9□W, M9□WV	3	4	5.5	7	7	7.5
D-M9□A, M9□AV						

* Since the operating range is provided as a guideline including hysteresis, it cannot be guaranteed (assuming approximately ±30% dispersion). It may vary substantially depending on an ambient environment.

Minimum Stroke for Auto Switch Mounting

No. of auto switches mounted	Applicable auto switch		
	D-A9□, D-A9□V	D-M9□, D-M9□V	D-M9□W, D-M9□WV D-M9□A, D-M9□AV
1 pc.	5	5	5
2 pcs.	10	5	10

(mm)

Auto Switch Groove Position

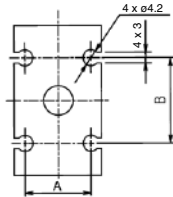

Bore size (mm)	A	B
6	8.2	9
10	10.3	13
16	15	18
20	21	23
25	27	25
32	35	27

(mm)

Caution on Proximity Installation

When free mounting cylinders equipped with auto switches are used, the auto switches could activate unintentionally if the installed distance is less than the dimensions shown in the table. Therefore, make sure to provide a greater clearance. Due to unavoidable circumstances, if they must be used with less distance than the dimensions given in the table, the cylinders must be shielded. Therefore, affix a steel plate or a magnetic shield plate (MU-S025) to the area on the cylinder that corresponds to the adjacent auto switch. (Please contact SMC for details.) Auto switches may malfunction if a shield plate is not used.

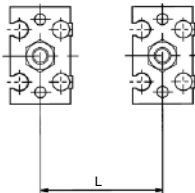

Bore size (mm)	Mounting pitch L (mm)
6	18
10	20
16	33
20	40
25	46
32	56

Dimensions of shield plate (MU-S025) that is sold separately are indicated as reference.

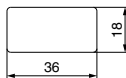

Material: Ferrite stainless steel, Thickness: 0.3 mm
The product can be attached to the cylinder since the bottom side is a seal type.

Free Mount Cylinder Double Acting, Double Rod **CUW Series** ø6, ø10, ø16, ø20, ø25, ø32

How to Order

CUW 6 [] - 30 D

With auto switch **CDUW 6 [] - 30 D - M9BW []**

Built-in magnet

Double rod

Bore size

6	6 mm
10	10 mm
16	16 mm
20	20 mm
25	25 mm
32	32 mm

Port thread type

Symbol	Type	Bore size
Nil	M5 x 0.8	ø6, ø10, ø16, ø20, ø25
	Rc 1/8	ø32
TN	NPT 1/8	ø32
TF	G 1/8	ø32

Number of auto switches

Nil	2 pcs.
S	1 pc.

Auto switch

Nil	Without auto switch
-----	---------------------

* Refer to the table below for applicable auto switches.

Action

D	Double acting
---	---------------

Built-in Magnet Cylinder Model

If a built-in magnet cylinder without an auto switch is required, there is no need to enter the symbol for the auto switch.
(Example): CDUW20-30D

Standard stroke (mm)

ø6, ø10, ø16	5, 10, 15, 20, 25, 30, 40, 50, 60
ø20, ø25, ø32	5, 10, 15, 20, 25, 30, 40, 50, 60, 70, 80, 90, 100

Applicable Auto Switches/Refer to pages 1271 to 1365 for further information on auto switches.

Type	Special function	Electrical entry	Polarity/light	Wiring (Output)	Load voltage		Auto switch model		Lead wire length (m)				Pre-wired connector	Applicable load					
					DC	AC	Perpendicular	In-line	0.5 (Nil)	1 (M)	3 (L)	5 (Z)		Relay, PLC	Relay, PLC				
Solid state auto switch	—	Grommet	Yes	3-wire (NPN)	24 V	5 V, 12 V	—	M9NV	M9N	●	●	○	○			IC circuit	—		
				3-wire (PNP)				M9PV	M9P	●	●	○	○						
				2-wire				M9BV	M9B	●	●	○	○						
	3-wire (NPN)			M9NVW				M9NW	●	●	○	○	IC circuit						
	3-wire (PNP)			M9PVW				M9PW	●	●	○	○							
	2-wire			M9BWW				M9BW	●	●	○	○							
Reed auto switch	—	Grommet	Yes	3-wire (NPN)	24 V	5 V, 12 V	—	M9NAV ^{*1}	M9NA ^{*1}	○	○	●	○	IC circuit	—				
				3-wire (PNP)				M9PAV ^{*1}	M9PA ^{*1}	○	○	○	○						
				2-wire				M9BAV ^{*1}	M9BA ^{*1}	○	○	●	○	IC circuit					
				3-wire (NPN equivalent)				A96V	A96	●	—	●	—			IC circuit			
				No				2-wire	24 V	12 V	100 V	A93V ^{*2}	A93	●			●	●	●
												100 V or less	A90V	A90		●	—	●	—

*1 Water resistant type auto switches can be mounted on the above models, but in such case SMC cannot guarantee water resistance.

Consult with SMC regarding water resistant types with the above model numbers.

*2 1 m type lead wire is only applicable to D-A93.

* Lead wire length symbols: 0.5 m Nil (Example) M9NW * Solid state auto switches marked with "○" are produced upon receipt of order.
1 m M (Example) M9NWM
3 m L (Example) M9NWL
5 m Z (Example) M9NZZ

* Since there are applicable auto switches other than the above, refer to page 782 for details.

* For detail about auto switches with pre-wired connector, refer to pages 1340 and 1341.

* Auto switches are shipped together but not assembled.

Free Mount Cylinder **CUW Series**



Specifications

Bore size (mm)	6	10	16	20	25	32
Fluid	Air					
Proof pressure	1.05 MPa					
Maximum operating pressure	0.7 MPa					
Minimum operating pressure	0.15 MPa	0.10 MPa			0.08 MPa	
Ambient and fluid temperature	Without auto switch: -10 to 70°C (No freezing) With auto switch: -10 to 60°C (No freezing)					
Lubrication	Non-lube					
Piston speed	50 to 500 mm/s					
Cushion	Rubber bumper					
Rod end thread	Male thread					
Stroke length tolerance	$\begin{matrix} +1.0 \\ 0 \end{matrix}$ mm					

Standard Stroke

Bore size (mm)	Standard stroke (mm)
6, 10, 16	5, 10, 15, 20, 25, 30, 40, 50, 60
20, 25, 32	5, 10, 15, 20, 25, 30, 40, 50, 60, 70, 80, 90, 100

Theoretical Output

(N)

Bore size (mm)	Rod size (mm)	Piston area (mm ²)	Operating pressure (MPa)		
			0.3	0.5	0.7
6	3	21.2	6.36	10.6	14.8
10	4	66.0	19.8	33.0	46.2
16	6	172	51.6	86.0	121
20	8	264	79.2	132	185
25	10	412	124	206	288
32	12	691	207	346	484

Symbol

Double acting, Single rod, Rubber bumper

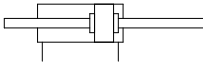

Weight(): Denotes the values with D-A93.

(g)

Model	Stroke (mm)												
	5	10	15	20	25	30	40	50	60	70	80	90	100
C(D)JUW6-□D	27 (32)	30 (40)	34 (44)	37 (47)	40 (50)	44 (54)	51 (61)	58 (68)	65 (75)	—	—	—	—
C(D)JUW10-□D	44 (49)	49 (59)	53 (63)	58 (68)	62 (72)	67 (77)	76 (86)	85 (95)	94 (104)	—	—	—	—
C(D)JUW16-□D	74 (99)	81 (111)	88 (118)	95 (125)	102 (132)	109 (139)	123 (153)	137 (167)	151 (181)	—	—	—	—
C(D)JUW20-□D	132 (165)	145 (182)	158 (195)	171 (208)	184 (221)	197 (234)	223 (260)	250 (287)	275 (312)	301 (338)	327 (364)	353 (390)	379 (416)
C(D)JUW25-□D	240 (294)	260 (319)	280 (339)	300 (359)	321 (380)	341 (400)	381 (440)	421 (480)	461 (520)	501 (560)	541 (600)	581 (640)	621 (680)
C(D)JUW32-□D	365 (438)	394 (472)	422 (500)	451 (529)	479 (557)	508 (586)	586 (664)	622 (700)	679 (757)	736 (814)	793 (871)	850 (928)	907 (985)

* For the auto switch weight, refer to page 1271.

Tightening Torque

When mounting the CUW series, refer to page 728.

Moisture Control Tube IDK Series



When operating an actuator with a small diameter and a short stroke at a high frequency, the dew condensation (water droplet) may occur inside the piping depending on the conditions.

Simply connecting the moisture control tube to the actuator will prevent dew condensation from occurring. For details, refer to the [Web Catalog](#).

CUW Series

Construction

ø6

With auto switch

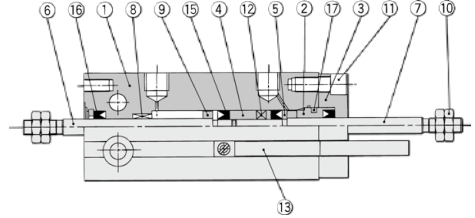
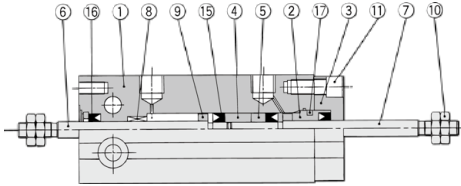

ø10

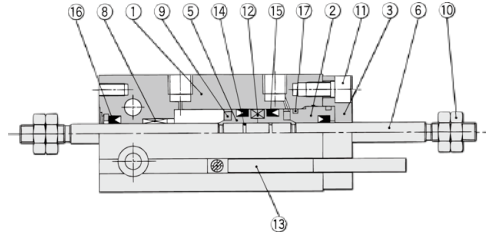
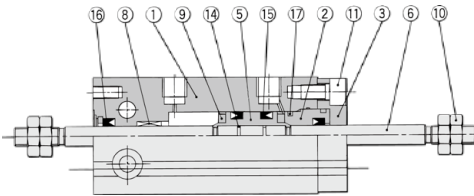

ø16 to ø32

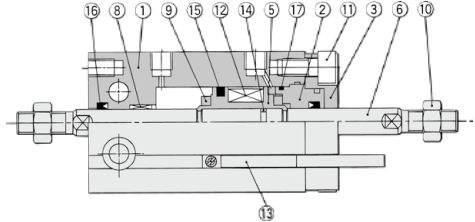
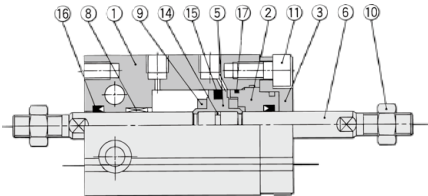

Component Parts

No.	Description	Material	Note
1	Cylinder tube	Aluminum alloy	Hard anodized
2	Rod cover	Aluminum alloy	Chromated
3	Rod cover retainer	Aluminum alloy	Hard anodized
4	Piston	Brass	ø6
5	Piston	Brass	ø6
		Aluminum alloy	ø10 to ø32, Chromated
6	Piston rod	Stainless steel	
7	Piston rod	Stainless steel	ø6
8	Bushing	Bearing alloy	

Component Parts

No.	Description	Material	Note
9	Bumper	Urethane	
10	Rod end nut	Carbon steel	Chromated
11	Hexagon socket head cap screw	Carbon steel	Chromated
12	Magnet	—	
13	Auto switch	—	
14	Piston gasket	NBR	
15*	Piston seal		
16*	Rod seal		
17*	Gasket		

Replacement Parts: Seal Kit

Kit no.	Bore size (mm) / Part no.				
	10	16	20	25	32
	CUW10D-PS	CUW16D-PS	CUW20D-PS	CUW25D-PS	CUW32D-PS

* Seal kit includes (15, 16, 17). Order the seal kit, based on each bore size.

* Seal kit includes a grease pack (10 g).

Order with the following part number when only the grease pack is needed.

Grease pack part number: GR-S-010 (10 g)

Dimensions: Double Acting, Double Rod

ø6, ø10

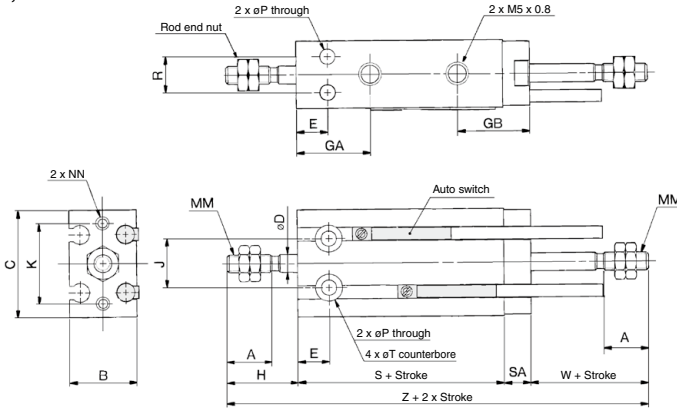

ø16 to ø32

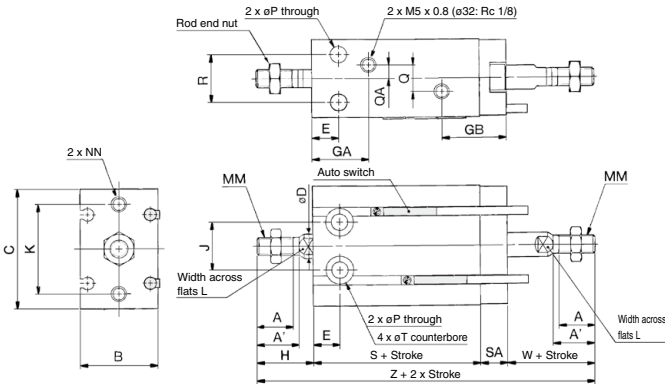

Rod End Nut/Accessory

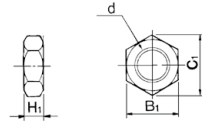

Material: Carbon steel

Part no.	Applicable bore size (mm)	d	H ₁	B ₁	C ₁
NTP-006	6	M3 x 0.5	1.8	5.5	6.4
NTP-010	10	M4 x 0.7	2.4	7	8.1
NTJ-015C	16	M5 x 0.8	4	8	9.2
NT-015A	20	M6 x 1.0	5	10	11.5
NT-02	25	M8 x 1.25	5	13	15.0
NT-03	32	M10 x 1.25	6	17	19.6

Bore size (mm)	A	A'	B	C	D	E	GA	GB	H	J	K	L	MM	NN	P	Q	QA
6	7	—	13	22	3	7	15	16	13	10	17	—	M3 x 0.5	M3 x 0.5 depth 5	3.2	—	—
10	10	—	15	24	4	7	16.5	16	16	11	18	—	M4 x 0.7	M3 x 0.5 depth 5	3.2	—	—
16	11	12.5	20	32	6	7	16.5 ^{max}	19	16	14	25	5	M5 x 0.8	M4 x 0.7 depth 6	4.5	4	2
20	12	14	26	40	8	9	19	21.5	19	16	30	6	M6 x 1.0	M5 x 0.8 depth 8	5.5	9	4.5
25	15.5	18	32	50	10	10	21.5	22	23	20	38	8	M8 x 1.25	M5 x 0.8 depth 8	5.5	9	4.5
32	19.5	22	40	62	12	11	23	22.5	27	24	48	10	M10 x 1.25	M6 x 1.0 depth 9	6.6	13.5	4.5

Note 1) 5 stroke (CUW16-5D): GA = 14.5

Note 2) The two chamfered positions for the double rod type are not identical.

Bore size (mm)	R	SA	T	W	Without auto switch		With auto switch	
					S	Z	S	Z
6	7	6	6 depth 4.8	13	38	70	38	70
10	9	6	6 depth 5	16	36	74	36	74
16	12	7.5	7.6 depth 6.5	16	30	69.5	40	79.5
20	16	9	9.3 depth 8	19	36	83	46	93
25	20	9	9.3 depth 9	23	40	95	50	105
32	24	10	11 depth 11.5	27	42	106	52	116

C UW Series

Auto Switch Mounting

Proper Auto Switch Mounting Position (Detection at stroke end) and Mounting Height

D-A9□
 D-M9□
 D-M9□W
 D-M9□A

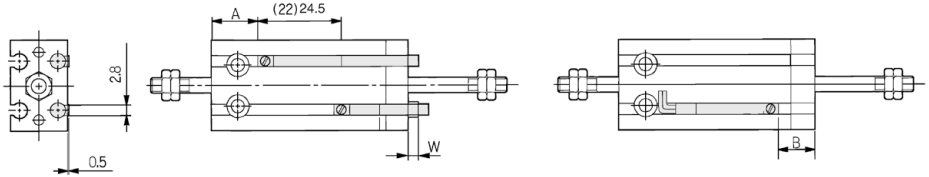

(): Denotes the values of D-A96.

D-A9□V
 D-M9□V
 D-M9□WV
 D-M9□AV

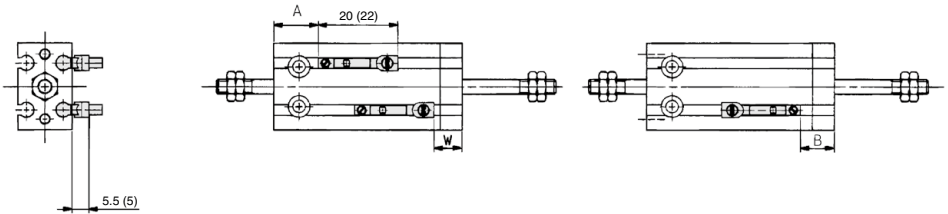

(): Denotes the values of D-A9□V.

Bore size (mm)	D-A9□, D-A9□V			D-M9□, D-M9□W			D-M9□V, D-M9□WV			D-M9□A			D-M9□AV		
	A	B	W	A	B	W	A	B	W	A	B	W	A	B	W
6	13.5	5.5	-3.5 (-1)	17.5	9.5	0.5	17.5	9.5	-1.5	17.5	9.5	2.5	17.5	9.5	0.5
10	12.5	9.5	-7.5 (-5)	16.5	13.5	-3.5	16.5	13.5	-5.5	16.5	13.5	-1.5	16.5	13.5	-3.5
16	16	11.5	-9.5 (-7)	20	15.5	-5.5	20	15.5	-7.5	20	15.5	-3.5	20	15.5	-5.5
20	20	15	-13 (-10.5)	24	19	-9	24	19	-11	24	19	-7	24	19	-9
25	22.5	16	-14.5 (-12)	26.5	20	-10.5	26.5	20	-12.5	26.5	20	-8.5	26.5	20	-10.5
32	23.5	18.5	-16.5 (-14)	27.5	22.5	-12.5	27.5	22.5	-14.5	27.5	22.5	-10.5	27.5	22.5	-12.5

(mm)

Note 1) Figures in the table above are used as a reference when mounting the auto switches for stroke end detection. In the case of actually setting the auto switches, adjust them after confirming their operation.

Note 2) Negative figures in the table W indicate an auto switch is mounted inward from the edge of the cylinder body.

Note 3) In the case of the 5 stroke or the 10 stroke, there are times in which the auto switch will not turn OFF or 2 auto switches will turn ON simultaneously due to their movement range. Therefore, set the position approximately 1 to 4 mm outward from the values given in the table above. Then, perform an operation inspection to make sure that the auto switches operate normally (if 1 switch is used, make sure that it turns ON and OFF properly; if 2 auto switches are used, make sure that both auto switches turn ON).

Note 4) () in column W is the dimensions of D-A90 and A93.

Operating Range

Auto switch model	Bore size (mm)					
	6	10	16	20	25	32
D-A9□, A9□V	5	6	9	11	12.5	14
D-M9□, M9□V						
D-M9□W, M9□WV	3	4	5.5	7	7	7.5
D-M9□A, M9□AV						

* Since the operating range is provided as a guideline including hysteresis, it cannot be guaranteed (assuming approximately ±30% dispersion). It may vary substantially depending on an ambient environment.

Minimum Stroke for Auto Switch Mounting

No. of auto switches mounted	Applicable auto switch		
	D-A9□, D-A9□V	D-M9□, D-M9□V	D-M9□W, D-M9□WV D-M9□A, D-M9□AV
1 pc.	5	5	5
2 pcs.	10	5	10

Free Mount Cylinder

Single Acting, Single Rod, Spring Return/Extend

CU Series

ø6, ø10, ø16, ø20, ø25, ø32

How to Order

CU 10 - **15** **S** -

With auto switch **CDU 10** - **15** **S** - **M9BW** -

Built-in magnet

Bore size

6	6 mm
10	10 mm
16	16 mm
20	20 mm
25	25 mm
32	32 mm

Port thread type

Symbol	Type	Bore size
Nil	M5 x 0.8	ø6, ø10, ø16, ø20, ø25
	Rc 1/8	ø32
TN	NPT 1/8	ø32
TF	G 1/8	ø32

Action

S	Single acting, Spring return
T	Single acting, Spring extend

Standard stroke (mm)

ø6, ø10, ø16	5, 10, 15
ø20, ø25, ø32	

Number of auto switches

Nil	2 pcs.
S	1 pc.

Auto switch

Nil	Without auto switch
-----	---------------------

* Refer to the table below for applicable auto switches.

Built-in Magnet Cylinder Model

If a built-in magnet cylinder without an auto switch is required, there is no need to enter the symbol for the auto switch.
(Example): CDU20-10S

* Made to Order
* Refer to page 740 for the Made to Order specifications.

Applicable Auto Switches

Refer to pages 1271 to 1365 for further information on auto switches.

Type	Special function	Electrical entry	Indicator/light	Wiring (Output)	Load voltage		Auto switch model		Lead wire length (m)				Pre-wired connector	Applicable load					
					DC	AC	Perpendicular	In-line	0.5 (Nil)	1 (M)	3 (L)	5 (Z)							
Solid state auto switch	—	Grommet	Yes	3-wire (NPN)	24 V	5 V, 12 V	—	M9NV	M9N	●	●	●	○	○	IC circuit				
				3-wire (PNP)				M9PV	M9P	●	●	●	○	○					
				2-wire				M9BV	M9B	●	●	●	○	○					
				3-wire (NPN)				M9NWX	M9NW	●	●	●	○	○					
	Diagnostic indication (2-color indicator)	Grommet	Yes	3-wire (PNP)	24 V	5 V, 12 V	—	M9PWX	M9PW	●	●	●	○	○	IC circuit				
				2-wire				M9BWX	M9BW	●	●	●	○	○					
				3-wire (NPN)				M9NAV ^{*1}	M9NA ^{*1}	○	○	○	○	○					
				3-wire (PNP)				M9PAV ^{*1}	M9PA ^{*1}	○	○	●	○	○					
Water resistant (2-color indicator)	Grommet	Yes	2-wire	24 V	12 V	—	M9BAV ^{*1}	M9BA ^{*1}	○	○	●	○	○	IC circuit					
			3-wire (NPN equivalent)				A96V	A96	●	—	●	—	—						
			No				2-wire	24 V	12 V	100 V	A93V ^{*2}	A93	●		—	●	●	—	Relay, PLC
								100 V or less	A90V	A90	●	—	●		—	—			

*1 Water resistant type auto switches can be mounted on the above models, but in such case SMC cannot guarantee water resistance.

Consult with SMC regarding water resistant types with the above model numbers.

*2 1 m type lead wire is only applicable to D-A93.

* Lead wire length symbols: 0.5 m Nil (Example) M9NW
 1 m M (Example) M9NWX
 3 m L (Example) M9NWL
 5 m Z (Example) M9NWX

* Solid state auto switches marked with "○" are produced upon receipt of order.

* Since there are applicable auto switches other than the above, refer to page 782 for details.

* For detail about auto switches with pre-wired connector, refer to pages 1340 and 1341.

* Auto switches are shipped together but not assembled.



Specifications

Bore size (mm)	6	10	16	20	25	32
Fluid	Air					
Proof pressure	1.05 MPa					
Maximum operating pressure	0.7 MPa					
Minimum operating pressure	0.2 MPa	0.15 MPa			0.13 MPa	
Ambient and fluid temperature	Without auto switch: -10 to 70°C (No freezing) With auto switch: -10 to 60°C (No freezing)					
Lubrication	Non-lube					
Piston speed	50 to 500 mm/s					
Cushion	Rubber bumper					
Rod end thread	Male thread					
Stroke length tolerance	$+1.0$ 0 mm					

(Note) $\phi 6$ with auto switch type: One side rubber bumper

Symbol

Single acting,
Spring return

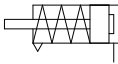

Single acting,
Spring extend

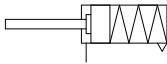

Rubber bumper

Standard Stroke

Bore size (mm)	Standard stroke (mm)
6, 10, 16, 20, 25, 32	5, 10, 15

Theoretical Output

(N)

Action	Bore size (mm)	Operating pressure (MPa)		
		0.3	0.5	0.7
Spring return (S)	$\phi 6$	4.99	10.7	16.3
	$\phi 10$	16.7	32.4	48.1
	$\phi 16$	45.6	86.3	126
	$\phi 20$	73	136	199
	$\phi 25$	119	218	316
	$\phi 32$	207	368	529
Spring extend (T)	$\phi 6$	2.86	7.10	11.3
	$\phi 10$	12.9	26.1	39.3
	$\phi 16$	37.2	71.8	106
	$\phi 20$	58	111	164
	$\phi 25$	95	178	260
	$\phi 32$	173	312	450

For the reactive force of spring return, refer to page 1572.



Made to Order Specifications
[Click here for details](#)

Symbol	Specifications
-XC22	Fluororubber seals

Weight/(g): Denotes the values with D-A93.

(g)

Model	Stroke (mm)		
	5	10	15
C(D)U6-□S,T	22 (27)	25 (35)	28 (38)
C(D)U10-□S,T	36 (41)	40 (50)	48 (58)
C(D)U16-□S,T	50 (75)	56 (86)	71 (101)
C(D)U20-□S,T	95 (128)	106 (143)	133 (170)
C(D)U25-□S,T	176 (230)	193 (252)	235 (294)
C(D)U32-□S,T	262 (335)	286 (364)	347 (425)

Tightening Torque

When mounting a CU single acting series, refer to page 728.

Spring reaction force

Refer to page 1572 (Table (3): Spring Reaction Force).

Moisture Control Tube IDK Series



When operating an actuator with a small diameter and a short stroke at a high frequency, the dew condensation (water droplet) may occur inside the piping depending on the conditions.

Simply connecting the moisture control tube to the actuator will prevent dew condensation from occurring. For details, refer to the [Web Catalog](#).

Construction

Single acting, Spring return

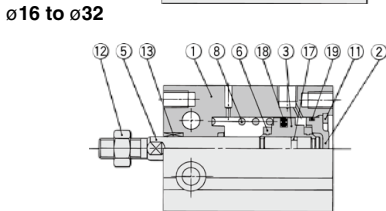
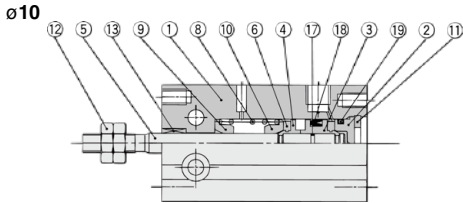
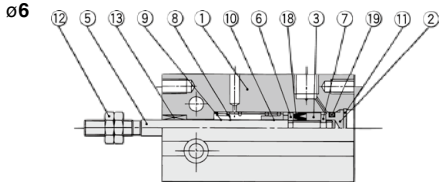

With auto switch

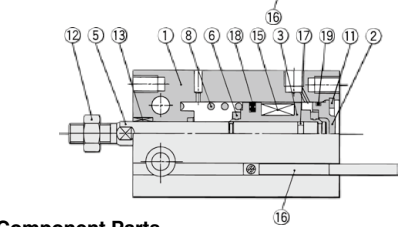
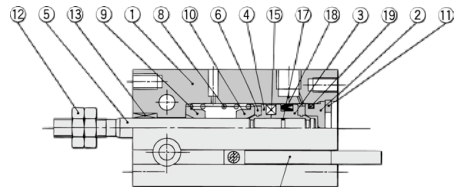
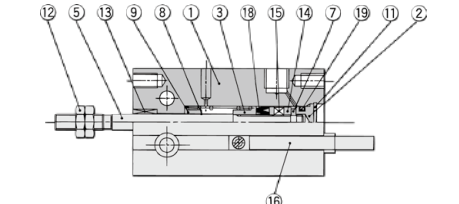

Component Parts

No.	Description	Material	Note
1	Cylinder tube	Aluminum alloy	Hard anodized
2	Head cover	Brass	ø6 to ø10, Electroless nickel plated
		Aluminum alloy	ø16 to ø32, Chromated
3	Piston	Brass	ø6
4	Piston	Aluminum alloy	ø10 to ø32, Chromated
5	Piston rod	Aluminum alloy	ø10
6	Bumper A	Stainless steel	
7	Bumper B	Urethane	
8	Return spring	Urethane	
		Piano wire	Zinc chromated

Component Parts

No.	Description	Material	Note
9	Spring seat	Brass	
10	Spring seat	Brass	
11	Retaining ring	Carbon tool steel	Phosphate coated
12	Rod end nut	Carbon steel	Chromated
13	Bushing	Bearing alloy	
14	Magnet holder	Brass	ø6
15	Magnet	—	
16	Auto switch	—	
17	Piston gasket		
18*	Piston seal	NBR	
19*	Gasket		

Replacement Parts: Seal Kit

Kit no.	Bore size (mm) / Part no.				
	10	16	20	25	32
	CU10S-PS	CU16S-PS	CU20S-PS	CU25S-PS	CU32S-PS

* Seal kit includes 18, 19. Order the seal kit, based on each bore size.

* Seal kit includes a grease pack (10 g).

Order with the following part number when only the grease pack is needed.

Grease pack part number: GR-S-010 (10 g)

CU Series

Construction

Single acting, Spring extend

ø6

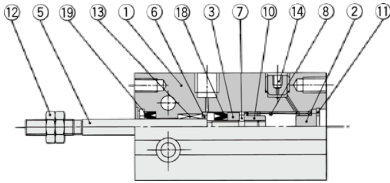

With auto switch

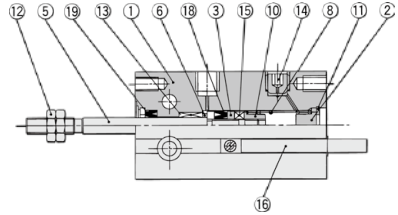

ø10

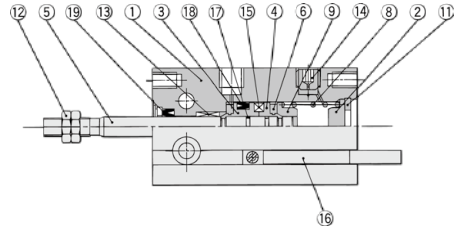
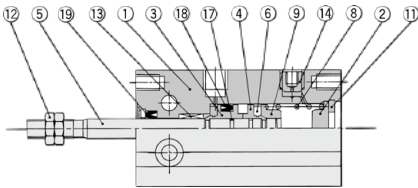

ø16 to ø32

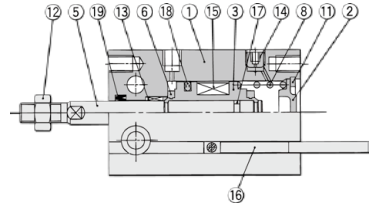
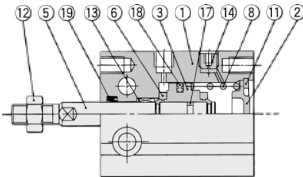

Component Parts

No.	Description	Material	Note
1	Cylinder tube	Aluminum alloy	Hard anodized
2	Head cover	Brass	ø6 to ø10, Electroless nickel plated
		Aluminum alloy	ø16 to ø32, Chromated
3	Piston	Brass	ø6
		Aluminum alloy	ø10 to ø32, Chromated
4	Piston	Aluminum alloy	ø10, Chromated
5	Piston rod	Stainless steel	
6	Bumper A	Urethane	
7	Bumper B	Urethane	
8	Return spring	Piano wire	Zinc chromated

Component Parts

No.	Description	Material	Note
9	Spring seat	Brass	
10	Stopper	Brass	ø6
11	Retaining ring	Carbon tool steel	Phosphate coated
12	Rod end nut	Carbon steel	Chromated
13	Bushing	Bearing alloy	
14	Plug with fixed orifice	Alloy steel	Black dyed
15	Magnet	—	
16	Auto switch	—	
17	Piston gasket		
18*	Piston seal	NBR	
19*	Rod seal		

Replacement Parts: Seal Kit

Kit no.	Bore size (mm) / Part no.				
	10	16	20	25	32
	CU10T-PS	CU16T-PS	CU20T-PS	CU25T-PS	CU32T-PS

* Seal kit includes 18, 19. Order the seal kit, based on each bore size.

* Seal kit includes a grease pack (10 g).

Order with the following part number when only the grease pack is needed.

Grease pack part number: GR-S-010 (10 g)

Dimensions: Single Acting, Spring Return

ø6, ø10

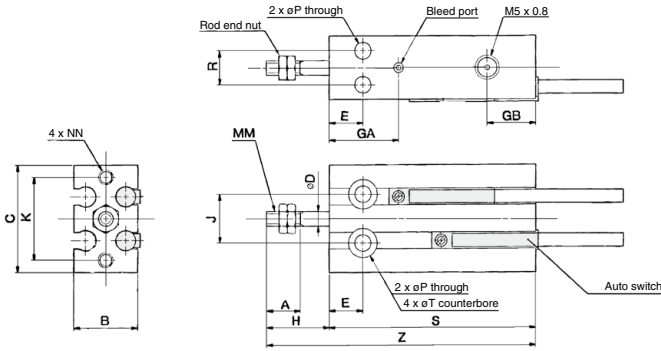

ø16 to ø32

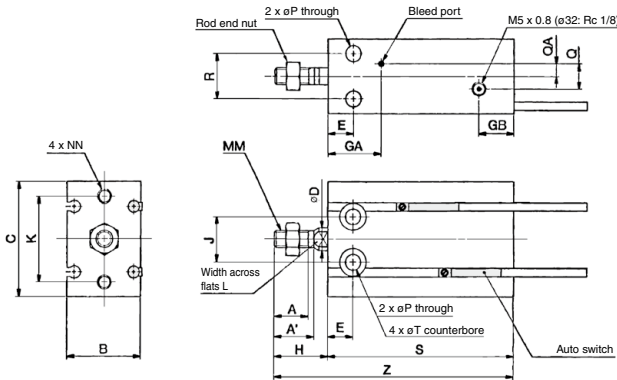

Rod End Nut/Accessory

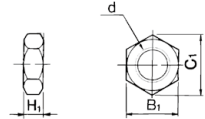

Material: Carbon steel

Part no.	Applicable bore size (mm)	d	H ₁	B ₁	C ₁
NTP-006	6	M3 x 0.5	1.8	5.5	6.4
NTP-010	10	M4 x 0.7	2.4	7	8.1
NTJ-015C	16	M5 x 0.8	4	8	9.2
NT-015A	20	M6 x 1.0	5	10	11.5
NT-02	25	M8 x 1.25	5	13	15.0
NT-03	32	M10 x 1.25	6	17	19.6

(mm)

Bore size (mm)	A	A'	B	C	D	E	GA	GB	H	J	K	L	MM	NN	P	Q	QA	R	T
6	7	—	13	22	3	7	15	10	13	10	17	—	M3 x 0.5	M3 x 0.5 depth 5	3.2	—	—	7	6 depth 4.8
10	10	—	15	24	4	7	16.5	10	16	11	18	—	M4 x 0.7	M3 x 0.5 depth 5	3.2	—	—	9	6 depth 5
16	11	12.5	20	32	6	7	16.5	11.5	16	14	25	5	M5 x 0.8	M4 x 0.7 depth 6	4.5	4	2	12	7.6 depth 6.5
20	12	14	26	40	8	9	19	12.5	19	16	30	6	M6 x 1.0	M5 x 0.8 depth 8	5.5	9	4.5	16	9.3 depth 8
25	15.5	18	32	50	10	10	21.5	13	23	20	38	8	M8 x 1.25	M5 x 0.8 depth 8	5.5	9	4.5	20	9.3 depth 9
32	19.5	22	40	62	12	11	23	12.5	27	24	48	10	M10 x 1.25	M6 x 1.0 depth 9	6.6	13.5	4.5	24	11 depth 11.5

Bore size (mm)	Without auto switch						With auto switch					
	S		Z		S		Z		S		Z	
	5 st	10 st	15 st	5 st	10 st	15 st	5 st	10 st	15 st	5 st	10 st	15 st
6	38	43	48	51	56	61	38	43	48	51	56	61
10	41	46	56	57	62	72	41	46	56	57	62	72
16	35	40	50	51	56	66	45	50	60	61	66	76
20	41	46	56	60	65	75	51	56	66	70	75	85
25	45	50	60	68	73	83	55	60	70	78	83	93
32	47	52	62	74	79	89	57	62	72	84	89	99

CU Series

Dimensions: Single Acting, Spring Extend

ø6, ø10

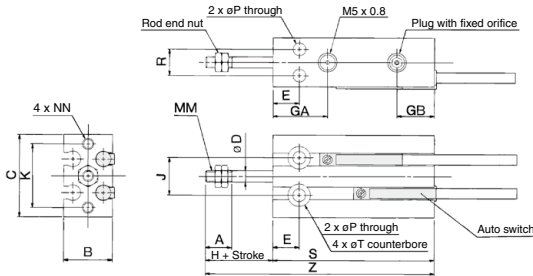

ø16 to ø32

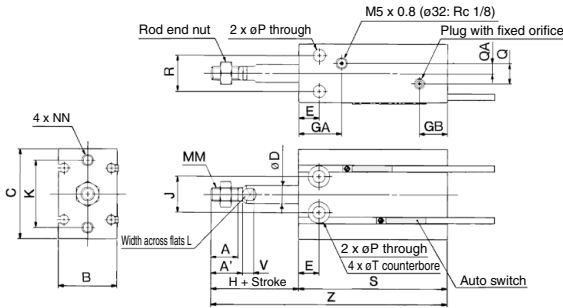

Rod End Nut/Accessory

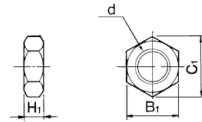

Material: Carbon steel

Part no.	Applicable bore size (mm)	d	H	B ₁	C ₁
NTP-006	6	M3 x 0.5	1.8	5.5	6.4
NTP-010	10	M4 x 0.7	2.4	7	8.1
NTJ-015A	16	M5 x 0.8	4	8	9.2
NT-015A	20	M6 x 1.0	5	10	11.5
NT-02	25	M8 x 1.25	5	13	15.0
NT-03	32	M10 x 1.25	6	17	19.6

(mm)

Bore size (mm)	A	A'	B	C	D	E	GA	GB	H	J	K	L	MM	NN	P	Q	QA	R	T	V
6	7	—	13	22	3	7	15	10	13	10	17	—	M3 x 0.5	M3 x 0.5 depth 5	3.2	—	—	7	6 depth 4.8	—
10	10	—	15	24	4	7	16.5	10	16	11	18	—	M4 x 0.7	M3 x 0.5 depth 5	3.2	—	—	9	6 depth 5	—
16	11	12.5	20	32	6	7	16.5	11.5	16	14	25	5	M5 x 0.8	M4 x 0.7 depth 6	4.5	4	2	12	7.6 depth 6.5	3.5
20	12	14	26	40	8	9	19	12.5	19	16	30	6	M6 x 1.0	M5 x 0.8 depth 8	5.5	9	4.5	16	9.3 depth 8	5
25	15.5	18	32	50	10	10	21.5	13	23	20	38	8	M8 x 1.25	M5 x 0.8 depth 8	5.5	9	4.5	20	9.3 depth 9	5
32	19.5	22	40	62	12	11	23	12.5	27	24	48	10	M10 x 1.25	M6 x 1.0 depth 9	6.6	13.5	4.5	24	11 depth 11.5	5

Bore size (mm)	Without auto switch						With auto switch					
	S			Z			S			Z		
	5 st	10 st	15 st	5 st	10 st	15 st	5 st	10 st	15 st	5 st	10 st	15 st
6	38	43	48	56	66	76	38	43	48	56	66	76
10	41	46	56	62	72	87	41	46	56	62	72	87
16	45	50	60	66	76	91	45	50	60	66	76	91
20	41	46	56	65	75	90	51	56	66	75	85	100
25	45	50	60	73	83	98	55	60	70	83	93	108
32	47	52	62	79	89	104	57	62	72	89	99	114

Auto Switch Mounting

Minimum Stroke for Auto Switch Mounting

No. of auto switches mounted	Applicable auto switch		
	D-A9□, D-A9□V	D-M9□, D-M9□V	D-M9□W, D-M9□WV D-M9□A, D-M9□AV
1 pc.	5	5	5
2 pcs.	10	5	10

Proper Auto Switch Mounting Position (Detection at Stroke End) and Mounting Height: Single Acting, Spring Return

D-A9□
D-M9□
D-M9□W
D-M9□A

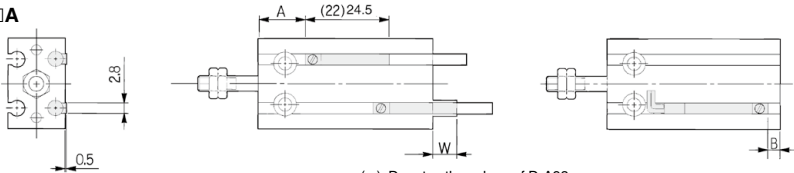

D-A9□V
D-M9□V
D-M9□WV
D-M9□AV

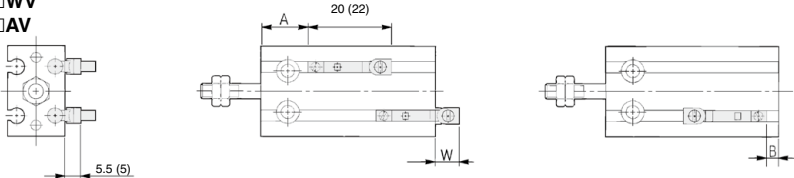

Single Acting, Spring Return

Bore size (mm)	Stroke	D-A9□, D-A9□V			D-M9□, D-M9□W			D-M9□V, D-M9□WV			D-M9□A			D-M9□AV		
		A	B	W	A	B	W	A	B	W	A	B	W	A	B	W
6	All stroke	13.5	0	2.5 (5)	17.5	4	6.5	17.5	4	4.5	17.5	4	8.5	17.5	4	6.5
	5, 10, 15	12.5, 17.5	3.5	-1.5 (1)	16.5, 21.5	7.5	2.5	16.5, 21.5	7.5	0.5	16.5, 21.5	7.5	4.5	16.5, 21.5	7.5	2.5
10	5, 10, 15	16, 21	4	-2 (0.5)	20, 25	8	2	20, 25	8	-0.5	20, 25	8	4	20, 25	8	1.5
	20	5, 10, 15, 20, 25	20, 25	6	-4 (-1.5)	24, 29	10	0	24, 29	10	-2	24, 29	10	2	24, 29	10
25	5, 10, 15, 20, 25	22.5, 27.5	7	-5.5 (-3)	26.5, 31.5	11	-1.5	26.5, 31.5	11	-3.5	26.5, 31.5	11	0.5	26.5, 31.5	11	-1.5
	32	5, 10, 15, 20, 25, 32	23.5, 28.5	8.5	-6.5 (-4)	27.5, 32.5	12.5	-2.5	27.5, 32.5	12.5	-4.5	27.5, 32.5	12.5	-0.5	27.5, 32.5	12.5

Single Acting, Spring Extend

Bore size (mm)	Stroke	D-A9□, D-A9□V			D-M9□, D-M9□W			D-M9□V, D-M9□WV			D-M9□A			D-M9□AV		
		A	B	W	A	B	W	A	B	W	A	B	W	A	B	W
6	All stroke	10.5	1.5	0.5 (3)	14.5	5.5	4.5	14.5	5.5	2.5	14.5	5.5	6.5	14.5	5.5	4.5
	5, 10, 15	12.5	3.5	-1.5 (1)	16.5	7.5	2.5	16.5	7.5	0.5	16.5	7.5	4.5	16.5	7.5	2.5
10	5, 10, 15	16	4	-2 (0.5)	20	8	2	20	8	0	20	8	4	20	8	2
	20	5, 10, 15, 20	20	6	-4 (-1.5)	24	10	0	24	10	-2	24	10	2	24	10
25	5, 10, 15, 20, 25	22.5	7	-5.5 (-3)	26.5	11	-1.5	26.5	11	-3.5	26.5	11	0.5	26.5	11	-1.5
	32	5, 10, 15, 20, 25, 32	23.5	8.5	-6.5 (-4)	27.5	12.5	-2.5	27.5	12.5	-4.5	27.5	12.5	-0.5	27.5	12.5

Note 1) Figures in the table above are used as a reference when mounting the auto switches for stroke end detection. In the case of actually setting the auto switches, adjust them after confirming their operation.

Note 2) Negative figures in the table W indicate an auto switch is mounted inward from the edge of the cylinder body.

Note 3) In the case of the 5 stroke or the 10 stroke, there are times in which the auto switch will not turn OFF or 2 auto switches will turn ON simultaneously due to their movement range. Therefore, set the position approximately 1 to 4 mm outward from the values given in the table above. Then, perform an operation inspection to make sure that the auto switches operate normally (if 1 switch is used, make sure that it turns ON and OFF properly; if 2 auto switches are used, make sure that both auto switches turn ON).

Note 4) () in column W is the dimensions of D-A90 and A93.

Free Mount Cylinder: Non-rotating Rod Type Double Acting, Single Rod

CUK Series

ø6, ø10, ø16, ø20, ø25, ø32

How to Order

With auto switch

CUK 6 [] - 30 D - []

CDUK 6 [] - 30 D - M9BW [] - []

- Built-in magnet
- Non-rotating rod type
- Bore size

6	6 mm
10	10 mm
16	16 mm
20	20 mm
25	25 mm
32	32 mm
- Auto switch

Nil	Without auto switch
-----	---------------------
- Number of auto switches

Nil	2 pcs.
S	1 pc.
- Action

D	Double acting
---	---------------
- Standard stroke (mm)

ø6, ø10, ø16	5, 10, 15, 20, 25, 30
ø20, ø25, ø32	5, 10, 15, 20, 25, 30, 40, 50
- Made to Order
* Refer to page 747 for the Made to Order specifications.

Built-in Magnet Cylinder Model
If a built-in magnet cylinder without an auto switch is required, there is no need to enter the symbol for the auto switch.
(Example): CDUK20-25D

Port thread type

Symbol	Type	Bore size
Nil	M5 x 0.8 Rc 1/8	ø6, ø10, ø16, ø20, ø25 ø32
TN	NPT 1/8	ø32
TF	G 1/8	ø32

Applicable Auto Switches

Refer to pages 1271 to 1365 for further information on auto switches.

Type	Special function	Electrical entry	Indicator light	Wiring (Output)	Load voltage		Auto switch model		Lead wire length (m)				Pre-wired connector	Applicable load		
					DC	AC	Perpendicular	In-line	0.5 (Nil)	1 (M)	3 (L)	5 (Z)		IC circuit	Relay, PLC	
Solid state auto switch	—	Grommet	Yes	3-wire (NPN)	24 V	5 V, 12 V	—	M9NV	M9N	●	●	○	○	—	IC circuit	Relay, PLC
				3-wire (PNP)				M9PV	M9P	●	●	○	○			
				2-wire				M9BV	M9B	●	●	○	○			
	3-wire (NPN)			M9NWV				M9NW	●	●	○	○	IC circuit			
	3-wire (PNP)			M9PWW				M9PW	●	●	○	○	IC circuit			
	2-wire			M9BWW				M9BW	●	●	○	○	—			
Water resistant (2-color indicator)	Grommet	Yes	No	3-wire (NPN)	24 V	5 V, 12 V	—	M9NAV ^{#1}	M9NA ^{#1}	○	○	○	○	—	IC circuit	Relay, PLC
				3-wire (PNP)				M9PAV ^{#1}	M9PA ^{#1}	○	○	○	○			
				2-wire				M9BAV ^{#1}	M9BA ^{#1}	○	○	●	○			
Reed auto switch	—	Grommet	Yes	3-wire (NPN equivalent)	24 V	5 V	—	A96V	A96	●	—	●	—	—	IC circuit	—
				2-wire				100 V	A93V ^{#2}	A93	●	●	●			
			No	2-wire	24 V	12 V	100 V or less	A90V	A90	●	—	●	—	—	IC circuit	—

- *1 Water resistant type auto switches can be mounted on the above models, but in such case SMC cannot guarantee water resistance. Consult with SMC regarding water resistant types with the above model numbers.
- *2 1 m type lead wire is only applicable to D-A93.
- * Lead wire length symbols: 0.5 m Nil (Example) M9NW
1 m M (Example) M9NWM
3 m L (Example) M9NWL
5 m Z (Example) M9NWX
- * Solid state auto switches marked with "○" are produced upon receipt of order.
- * Since there are applicable auto switches other than the above, refer to page 782 for details.
- * For detail about auto switches with pre-wired connector, refer to pages 1340 and 1341.
- * Auto switches are shipped together but not assembled.

Free Mount Cylinder: Non-rotating Rod Type Double Acting, Single Rod **CUK Series**

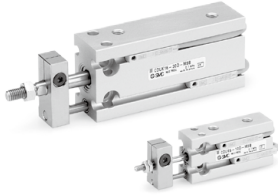

Symbol

Double acting, Single rod, Rubber bumper

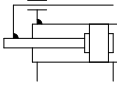

Standard Stroke

Bore size (mm)	Standard stroke (mm)
6, 10, 16	5, 10, 15, 20, 25, 30
20, 25, 32	5, 10, 15, 20, 25, 30, 40, 50

Note) For long stroke, refer to page 764.



Made to Order Specifications

[Click here for details](#)

Symbol	Specifications
-XB6	Heat resistant (-10 to 150°C)
-XB7	Cold resistant (-40 to 70°C)
-XB9	Low speed (10 to 50 mm/s)
-XB13	Low speed (5 to 50 mm/s)
-XC19	Intermediate stroke (5 mm spacer)
-XC22	Fluororubber seals
-XC34	Non-rotating plate with workpiece mounting screw (No extended part on the rod end)

Moisture Control Tube IDK Series



When operating an actuator with a small diameter and a short stroke at a high frequency, the dew condensation (water droplet) may occur inside the piping depending on the conditions.

Simply connecting the moisture control tube to the actuator will prevent dew condensation from occurring. For details, refer to the [Web Catalog](#).

Specifications

Bore size (mm)	6	10	16	20	25	32
Fluid	Air					
Proof pressure	1.05 MPa					
Maximum operating pressure	0.7 MPa					
Minimum operating pressure	0.15 MPa	0.10 MPa			0.08 MPa	
Ambient and fluid temperature	Without auto switch: -10 to 70°C (No freezing) With auto switch: -10 to 60°C (No freezing)					
Lubrication	Non-lube					
Piston speed	50 to 500 mm/s					
Cushion	Rubber bumper					
Rod end thread	Male thread					
Stroke length tolerance	$\begin{matrix} +1.0 \\ 0 \end{matrix}$ mm					
Rod non-rotating accuracy ^{Note)}	$\pm 0.8^\circ$			$\pm 0.5^\circ$		

Note) No load: Rod at retracted

Minimum Stroke for Auto Switch Mounting

(mm)

No. of auto switches mounted	Applicable auto switch		
	D-A9□, D-A9□V	D-M9□, D-M9□V	D-M9□W, D-M9□VW
1 pc.	5	5	5
2 pcs.	10	5	10

Weight/(): Denotes the values with D-A93.

(g)

Bore size (mm)	Stroke (mm)							
	5	10	15	20	25	30	40	50
C(D)UK6-□D	28 (33)	31 (41)	34 (44)	37 (47)	40 (50)	43 (53)	—	—
C(D)UK10-□D	43 (48)	47 (57)	51 (61)	55 (65)	59 (69)	63 (73)	—	—
C(D)UK16-□D	60 (85)	66 (96)	72 (102)	78 (108)	84 (114)	90 (120)	—	—
C(D)UK20-□D	113 (147)	124 (164)	136 (176)	148 (188)	160 (200)	172 (211)	195 (235)	219 (260)
C(D)UK25-□D	212 (266)	229 (288)	246 (305)	263 (322)	280 (339)	297 (356)	335 (390)	370 (424)
C(D)UK32-□D	331 (404)	357 (435)	383 (461)	409 (487)	435 (513)	461 (539)	513 (591)	565 (643)

* For the auto switch weight, refer to page 1271.

Allowable Rotational Torque

Bore size (mm)	6	10	16	20	25	32
Allowable rotational torque (N·m)	0.0015	0.02	0.04	0.10	0.15	0.20

Tightening Torque

When mounting the CUK series, refer to page 732.

Theoretical Output

Specifications are the same as CU series double acting, single rod. Refer to page 728.

Auto Switch Mounting Position

For the auto switch mounting position of the CDUK series, refer to page 732, since specifications are the same as standard type, double acting, single rod type.

⚠ Precautions

Be sure to read this before handling the products. Refer to page 20 for safety instructions and pages 21 to 30 for actuator and auto switch precautions.

Operating Precautions

⚠ Caution

- Do not place your fingers in the clearance between the non-rotating plate and the cylinder tube.

Your fingers could get caught between the non-rotating plate and the cylinder tube when the piston rod retracts. Therefore, never place your finger in this area.

Because the cylinder outputs a great force, it could lead to injury if precautions are not taken to prevent your fingers from getting caught.

- When using the non-rotating type, make sure that rotational torque is not applied to the piston rod. If rotational torque must be applied due to unavoidable circumstances, make sure to use it at the allowable rotational torque or less, which is shown in the table on the right.

Construction

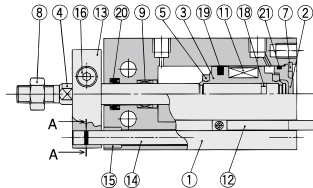
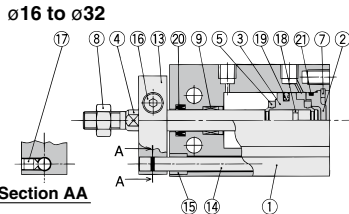
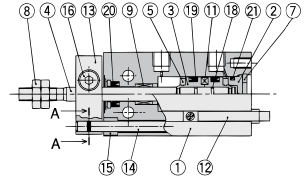
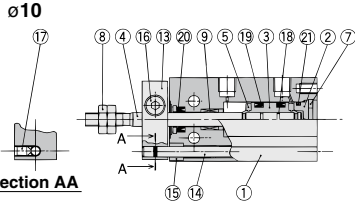
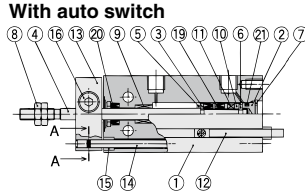
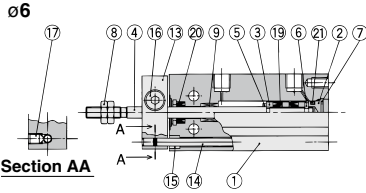

Component Parts

No.	Description	Material	Note
1	Cylinder tube	Aluminum alloy	Hard anodized
2	Head cover	Brass	ø6 to ø10, Electroless nickel plated
		Aluminum alloy	ø16 to ø32, Chromated
3	Piston	Brass	ø6
		Aluminum alloy	ø10 to ø32, Chromated
4	Piston rod	Stainless steel	
5	Bumper A	Urethane	
6	Bumper B	Urethane	
7	Retaining ring	Carbon tool steel	Phosphate coated
8	Rod end nut	Carbon steel	Chromated
9	Bushing	Oil-impregnated sintered alloy	
10	Magnet holder	Brass	ø6

Component Parts

No.	Description	Material	Note
11	Magnet	—	
12	Auto switch	—	
13	Non-rotating plate	Aluminum alloy	Nickel plated
14	Guide rod	Stainless steel	
15	Bushing	Bearing alloy	
16	Hexagon socket head cap screw	Carbon steel	Chromated
17	Hexagon socket head set screw	Carbon steel	Chromated
18	Piston gasket	NBR	
19*	Piston seal		
20*	Rod seal		
21*	Gasket		

Replacement Parts: Seal Kit

Bore size (mm)	Kit no.	Contents
10	CU10D-PS	Set of nos. above 19, 20, 21.
16	CU16D-PS	
20	CU20D-PS	
25	CU25D-PS	
32	CU32D-PS	

* Seal kit includes 19, 20, 21. Order the seal kit, based on each bore size.

* Seal kit includes a grease pack (10 g).

Order with the following part number when only the grease pack is needed.

Grease pack part number: GR-S-010 (10 g)

Dimensions: Non-rotating Rod Type; Double Acting, Single Rod

ø6, ø10

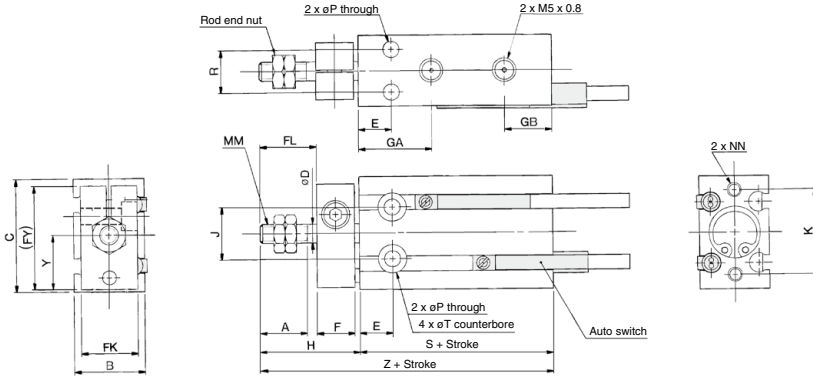

ø16 to ø32

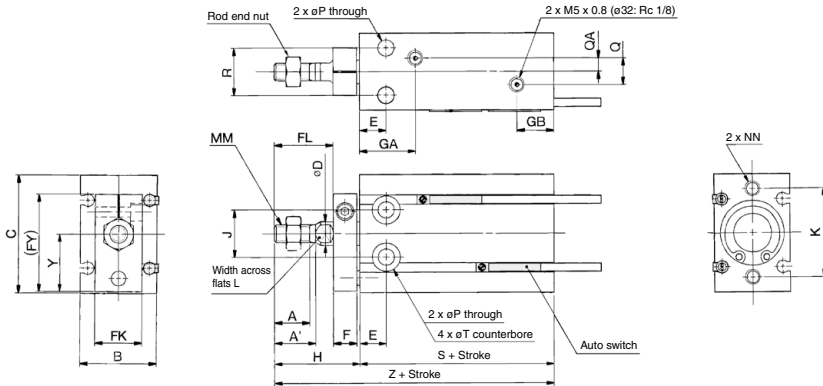

Rod End Nut/Accessory Material: Carbon steel

Part no.	Applicable bore size (mm)	d	H ₁	B ₁	C ₁
NTP-006	6	M3 x 0.5	1.8	5.5	6.4
NTP-010	10	M4 x 0.7	2.4	7	8.1
NTJ-015C	16	M5 x 0.8	4	8	9.2
NT-015A	20	M6 x 1.0	5	10	11.5
NT-02	25	M8 x 1.25	5	13	15.0
NT-03	32	M10 x 1.25	6	17	19.6

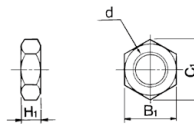

Bore size (mm)	A	A'	B	C	D	E	F	FL	FK	FY	GA	GB	H	J	K	L	MM
	6	7	—	13	22	3	7	8	9	11	20.5	15	10	18	10	17	—
10	10	—	15	24	4	7	8	12	12	22	16.5	10	21	11	18	—	M4 x 0.7
16	11	12.5	20	32	6	7	8	17	13	28	16.5 ^{Note}	11.5	26	14	25	5	M5 x 0.8
20	12	14	26	40	8	9	8	20	16	33	19	12.5	29	16	30	6	M6 x 1.0
25	15.5	18	32	50	10	10	10	22	20	43.5	21.5	13	33	20	38	8	M8 x 1.25
32	19.5	22	40	62	12	11	12	29	24	51.5	23	12.5	42	24	48	10	M10 x 1.25

Bore size (mm)	NN	P	Q	QA	R	T	Y	Without auto switch		With auto switch	
								S	Z	S	Z
6	M3 x 0.5 depth 5	3.2	—	—	7	6 depth 4.8	10.5	33	51	33	51
10	M3 x 0.5 depth 5	3.2	—	—	9	6 depth 5	11.5	36	57	36	57
16	M4 x 0.7 depth 6	4.5	4	2	12	7.6 depth 6.5	15.5	30	56	40	66
20	M5 x 0.8 depth 8	5.5	9	4.5	16	9.3 depth 8	19.5	36	65	46	75
25	M5 x 0.8 depth 8	5.5	9	4.5	20	9.3 depth 9	24.5	40	73	50	83
32	M6 x 1.0 depth 9	6.6	13.5	4.5	24	11 depth 11.5	30.5	42	84	52	94

Note) 5 stroke (CUK16-5D); GA = 14.5

Free Mount Cylinder: Non-rotating Rod Type Double Acting, Double Rod

CUKW Series

ø6, ø10, ø16, ø20, ø25, ø32

How to Order

With auto switch

CUKW 6 - 30 D

CDUKW 6 - 30 D - M9BW

Built-in magnet

Non-rotating rod type

Double rod

Bore size

6	6 mm
10	10 mm
16	16 mm
20	20 mm
25	25 mm
32	32 mm

Port thread type

Symbol	Type	Bore size
NII	M5 x 0.8	ø6, ø10, ø16, ø20, ø25
	Rc 1/8	ø32
TN	NPT 1/8	ø32
TF	G 1/8	ø32

Number of auto switches

NII	2 pcs.
S	1 pc.

Auto switch

NII	Without auto switch
-----	---------------------

* Refer to the table below for applicable auto switches.

Action

D	Double acting
---	---------------

Standard stroke (mm)

ø6, ø10, ø16	5, 10, 15, 20, 25, 30, 40, 50, 60
ø20, ø25, ø32	5, 10, 15, 20, 25, 30, 40, 50, 60, 70, 80, 90, 100

Built-in Magnet Cylinder Model

If a built-in magnet cylinder without an auto switch is required, there is no need to enter the symbol for the auto switch.
(Example): CDUKW20-25D

Applicable Auto Switches/Refer to pages 1271 to 1365 for further information on auto switches.

Type	Special function	Electrical entry	Indicator light	Wiring (Output)	Load voltage		Auto switch model		Lead wire length (m)					Pre-wired connector	Applicable load	
					DC	AC	Perpendicular	In-line	0.5 (Nil)	1 (M)	3 (L)	5 (Z)	IC		Relay, PLC	
Solid state auto switch	—	Grommet	Yes	3-wire (NPN)	5 V, 12 V	—	M9NV	M9N	●	●	●	○	○	○	Relay, PLC	
				3-wire (PNP)			M9PV	M9P	●	●	●	○	○			
				2-wire	M9BV		M9B	●	●	●	○	○				
	3-wire (NPN)			M9NWV	M9NW		●	●	●	○	○					
	3-wire (PNP)			M9PWW	M9PW		●	●	●	○	○					
	2-wire			M9BWW	M9BW		●	●	●	○	○					
Reed auto switch	—	Grommet	Yes	3-wire (NPN equivalent)	5 V	—	A96V	A96	●	—	●	—	—	—	Relay, PLC	
				2-wire			M9NAV ^{*1}	M9NA ^{*1}	○	○	●	○	○			
				3-wire (PNP)	M9PAV ^{*1}		M9PA ^{*1}	○	○	●	○	○				
				2-wire	M9BAV ^{*1}		M9BA ^{*1}	○	○	●	○	○				
				No	100 V		A93V ^{*2}	A93	●	●	●	●	—	—		
					100 V or less		A90V	A90	●	—	●	—	—	—		

*1 Water resistant type auto switches can be mounted on the above models, but in such case SMC cannot guarantee water resistance.

Consult with SMC regarding water resistant types with the above model numbers.

*2 1 m type lead wire is only applicable to D-A93.

* Lead wire length symbols: 0.5 m Nil (Example) M9NW
1 m M (Example) M9NWM
3 m L (Example) M9NWL
5 m Z (Example) M9NWX

* Solid state auto switches marked with "○" are produced upon receipt of order.

* Since there are applicable auto switches other than the above, refer to page 782 for details.

* For detail about auto switches with pre-wired connector, refer to pages 1340 and 1341.

* Auto switches are shipped together but not assembled.

Free Mount Cylinder: Non-rotating Rod Type Double Acting, Double Rod **CUKW Series**

Specifications

Bore size (mm)	6	10	16	20	25	32
Fluid	Air					
Proof pressure	1.05 MPa					
Maximum operating pressure	0.7 MPa					
Minimum operating pressure	0.18 MPa	0.13 MPa			0.11 MPa	
Ambient and fluid temperature	Without auto switch: -10 to 70°C (No freezing) With auto switch: -10 to 60°C (No freezing)					
Lubrication	Non-lube					
Piston speed	50 to 500 mm/s					
Cushion	Rubber bumper					
Rod end thread	Male thread					
Stroke length tolerance	+1.0 0 mm					
Rod non-rotating accuracy (Note)	±0.8°				±0.5°	

Note) No load: Rod in the non-rotating plate side at retracted

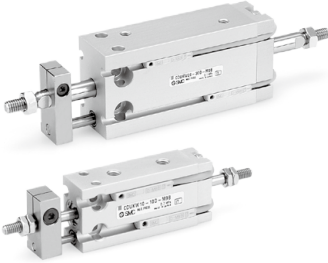

Symbol

Non-rotating rod, Rubber bumper

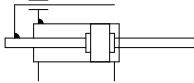

Standard Stroke

Bore size (mm)	Standard stroke (mm)
6, 10, 16	5, 10, 15, 20, 25, 30, 40, 50, 60
20, 25, 32	5, 10, 15, 20, 25, 30, 40, 50, 60, 70, 80, 90, 100

Minimum Stroke for Auto Switch Mounting

(mm)

No. of auto switches mounted	Applicable auto switch		
	D-A9□, D-A9□V	D-M9□, D-M9□V	D-M9□W, D-M9□WV
1 pc.	5	5	5
2 pcs.	10	5	10

Weight (): Denotes the values with D-A93.

(g)

Model	Stroke (mm)												
	5	10	15	20	25	30	40	50	60	70	80	90	100
C(D)UKW6-□D	33 (38)	36 (46)	40 (50)	43 (53)	46 (56)	50 (60)	57 (67)	64 (74)	71 (81)	—	—	—	—
C(D)UKW10-□D	51 (56)	56 (66)	60 (70)	65 (75)	69 (79)	74 (84)	83 (93)	92 (102)	101 (111)	—	—	—	—
C(D)UKW16-□D	84 (109)	91 (121)	98 (128)	105 (135)	112 (142)	119 (149)	133 (163)	147 (177)	161 (191)	—	—	—	—
C(D)UKW20-□D	150 (185)	163 (203)	177 (217)	191 (231)	205 (245)	219 (259)	247 (286)	275 (315)	303 (343)	331 (371)	359 (399)	387 (427)	415 (455)
C(D)UKW25-□D	276 (330)	296 (355)	316 (375)	336 (395)	357 (416)	377 (436)	421 (476)	462 (516)	500 (559)	541 (600)	582 (641)	623 (682)	664 (723)
C(D)UKW32-□D	434 (507)	465 (543)	495 (573)	526 (604)	556 (634)	587 (665)	669 (747)	709 (787)	770 (848)	831 (909)	892 (970)	953 (1031)	1014 (1092)

* For the auto switch weight, refer to page 1271.

Theoretical Output

Specifications are the same as double acting, double rod (CUW series). Refer to page 735.

Tightening Torque

When mounting the CUKW series, refer to page 728.

Allowable Rotational Torque

Ensure that rotational torque is not applied to the piston rod of the CUKW series. If rotational torque are applied unavoidably, refer to page 747.

Auto Switch Mounting Position

For the auto switch mounting position of the CUKW series, refer to page 738, since specifications are the same as double acting, double rod type.

Moisture Control Tube IDK Series



When operating an actuator with a small diameter and a short stroke at a high frequency, the dew condensation (water droplet) may occur inside the piping depending on the conditions.

Simply connecting the moisture control tube to the actuator will prevent dew condensation from occurring. For details, refer to the [Web Catalog](#).

CUKW Series

Construction

ø6

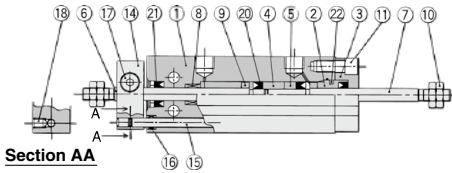

With auto switch

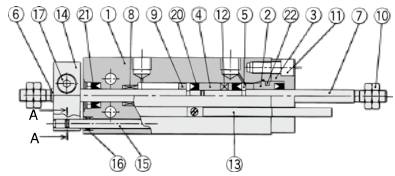

ø10

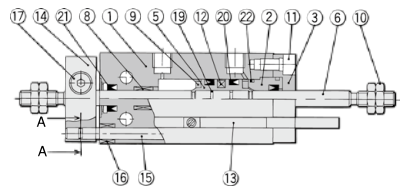
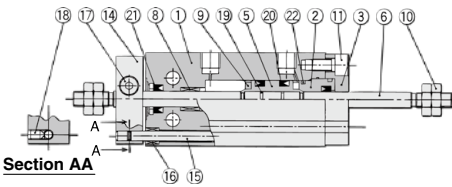

ø16 to ø32

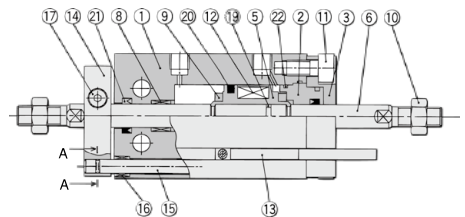
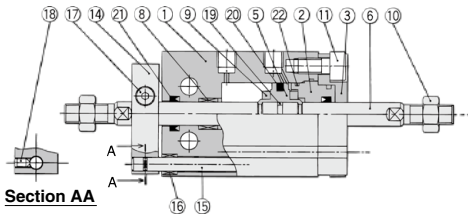

Component Parts

No.	Description	Material	Note
1	Cylinder tube	Aluminum alloy	Hard anodized
2	Rod cover	Aluminum alloy	Chromated
3	Rod cover retainer	Aluminum alloy	Hard anodized
4	Piston	Brass	ø6
5	Piston	Brass	ø6
	Piston	Aluminum alloy	ø10 to ø32, Chromated
6	Piston rod	Stainless steel	
7	Piston rod	Stainless steel	ø6
8	Bushing	Bearing alloy	
9	Bumper	Urethane	
10	Rod end nut	Carbon steel	Chromated
11	Hexagon socket head cap screw	Carbon steel	Chromated

Component Parts

No.	Description	Material	Note
12	Magnet	—	
13	Auto switch	—	
14	Non-rotating plate	Aluminum alloy	Nickel plated
15	Guide rod	Stainless steel	
16	Bushing	Bearing alloy	
17	Hexagon socket head cap screw	Carbon steel	Chromated
18	Hexagon socket head set screw	Carbon steel	Chromated
19	Piston gasket	NBR	
20*	Piston seal		
21*	Rod seal		
22*	Gasket		

Replacement Parts: Seal Kit

Kit no.	Bore size (mm) / Part no.				
	10	16	20	25	32
	CUW10D-PS	CUW16D-PS	CUW20D-PS	CUW25D-PS	CUW32D-PS

* Seal kit includes 20, 21, 22. Order the seal kit, based on each bore size.

* Seal kit includes a grease pack (10 g).

Order with the following part number when only the grease pack is needed.

Grease pack part number: GR-S-010 (10 g)

Dimensions: Non-rotating Rod Type; Double Acting, Double Rod

ø6, ø10

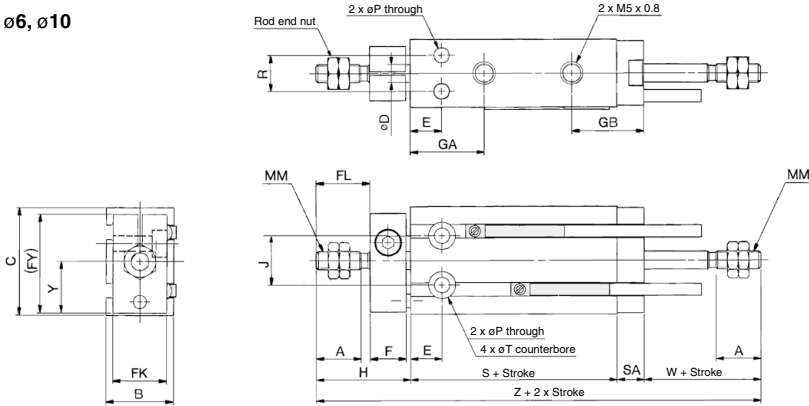

ø16 to ø32

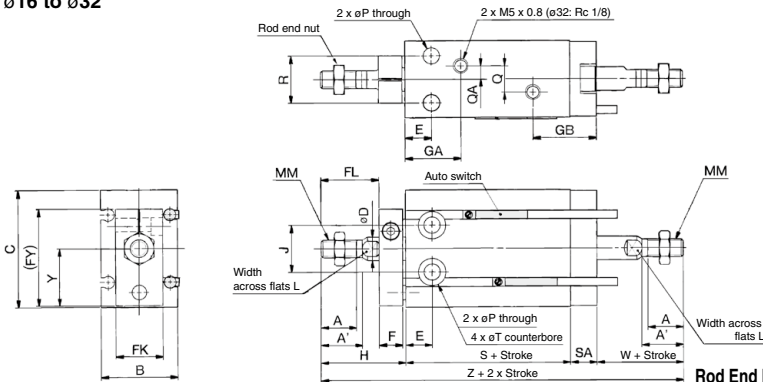

Rod End Nut/Accessory Material: Carbon steel

Part no.	Applicable bore size (mm)	d	H ₁	B ₁	C ₁
NTP-006	6	M3 x 0.5	1.8	5.5	6.4
NTP-010	10	M4 x 0.7	2.4	7	8.1
NTJ-015C	16	M5 x 0.8	4	8	9.2
NT-015A	20	M6 x 1.0	5	10	11.5
NT-02	25	M8 x 1.25	5	13	15.0
NT-03	32	M10 x 1.25	6	17	19.6

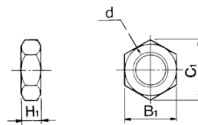

Bore size (mm)	A	A'	B	C	D	E	F	FL	FK	FY	GA	GB	H	J	L	MM
6	7	—	13	22	3	7	8	9	11	20.5	15	16	18	10	—	M3 x 0.5
10	10	—	15	24	4	7	8	12	12	22	16.5	16	21	11	—	M4 x 0.7
16	11	12.5	20	32	6	7	8	17	13	28	16.5 (Note)	19	26	14	5	M5 x 0.8
20	12	14	26	40	8	9	8	20	16	33	19	21.5	29	16	6	M6 x 1.0
25	15.5	18	32	50	10	10	10	22	20	43.5	21.5	22	33	20	8	M8 x 1.25
32	19.5	22	40	62	12	11	12	29	24	51.5	23	22.5	42	24	10	M10 x 1.25

Bore size (mm)	P	Q	QA	R	SA	T	W	Y	Without auto switch		With auto switch	
									S	Z	S	Z
6	3.2	—	—	7	6	6 depth 4.8	13	10.5	38	75	38	75
10	3.2	—	—	9	6	6 depth 5	16	11.5	36	79	36	79
16	4.5	4	2	12	7.5	7.6 depth 6.5	16	15.5	30	79.5	40	89.5
20	5.5	9	4.5	16	9	9.3 depth 8	19	19.5	36	93	46	103
25	5.5	9	4.5	20	9	9.3 depth 9	23	24.5	40	105	50	115
32	6.6	13.5	4.5	24	10	11 depth 11.5	27	30.5	42	121	52	131

Note 1) 5 stroke (CUKW16-5D): GA = 14.5

Note 2) The two chamfered positions for the double rod type are not identical.

Free Mount Cylinder: Non-rotating Rod Type Single Acting, Spring Return/Extend

CUK Series

ø6, ø10, ø16, ø20, ø25, ø32

How to Order

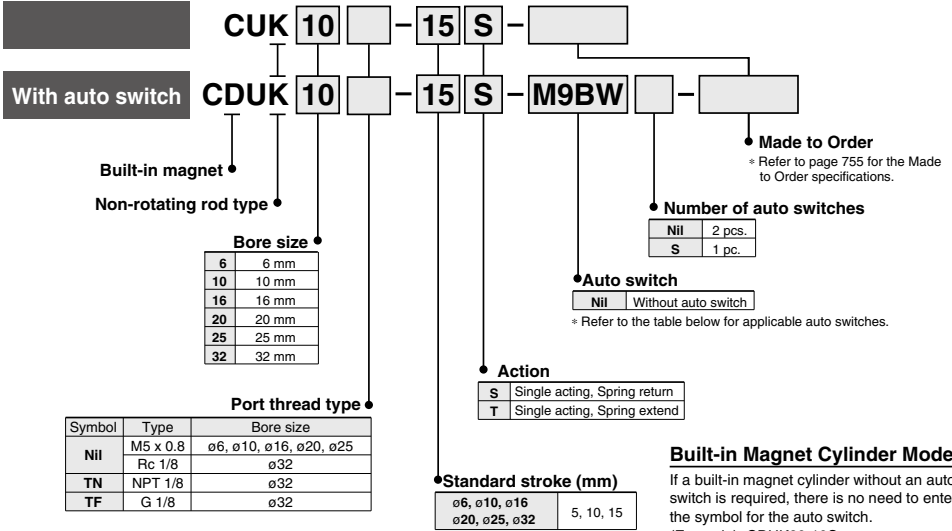

Built-in Magnet Cylinder Model

If a built-in magnet cylinder without an auto switch is required, there is no need to enter the symbol for the auto switch.
(Example): CDUK20-10S

Applicable Auto Switches/Refer to pages 1271 to 1365 for further information on auto switches.

Type	Special function	Electrical entry	Indicator light	Wiring (Output)	Load voltage		Auto switch model		Lead wire length (m)				Pre-wired connector	Applicable load						
					DC	AC	Perpendicular	In-line	0.5 (Nil)	1 (M)	3 (L)	5 (Z)								
Solid state auto switch	—	Grommet	Yes	3-wire (NPN)	24 V	5 V, 12 V	—	M9NV	M9N	●	●	○	○	IC circuit	Relay, PLC					
				3-wire (PNP)				M9PV	M9P	●	●	○	○			—				
				2-wire				M9BV	M9B	●	●	○	○							
	Diagnostic indication (2-color indicator)			3-wire (NPN)	5 V, 12 V	—	M9NWX	M9NW	●	●	○	○	IC circuit							
				3-wire (PNP)			M9PWX	M9PW	●	●	○	○		—						
				2-wire			M9BWX	M9BW	●	●	○	○								
Water resistant (2-color indicator)	3-wire (NPN)	5 V, 12 V	—	M9NAV ^{*1}	M9NA ^{*1}	○	○	○	○	IC circuit										
	3-wire (PNP)			M9PAV ^{*1}	M9PA ^{*1}	○	○	●	○		—									
	2-wire			M9BAV ^{*1}	M9BA ^{*1}	○	○	●	○											
Reed auto switch	—	Grommet	Yes	3-wire (NPN equivalent)	24 V	5 V	—	A96V	A96	●	●	○	○	IC circuit	—					
				No				2-wire	12 V	100 V	100 V or less	A93V ^{*2}	A93			●	●	●	—	Relay, PLC
								A90V				A90	●			—	●	—	—	

*1 Water resistant type auto switches can be mounted on the above models, but in such case SMC cannot guarantee water resistance.

Consult with SMC regarding water resistant types with the above model numbers.

*2 1 m type lead wire is only applicable to D-A93.

* Lead wire length symbols: 0.5 m Nil (Example) M9NW
1 m M (Example) M9NWM
3 m L (Example) M9NWL
5 m Z (Example) M9NWX

* Solid state auto switches marked with "○" are produced upon receipt of order.

* Since there are applicable auto switches other than the above, refer to page 782 for details.

* For detail about auto switches with pre-wired connector, refer to pages 1340 and 1341.

* Auto switches are shipped together but not assembled.

Free Mount Cylinder: Non-rotating Rod Type Single Acting, Spring Return/Extend **CUK Series**

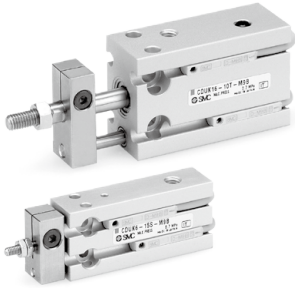

Specifications

Bore size (mm)	6	10	16	20	25	32
Fluid	Air					
Proof pressure	1.05 MPa					
Maximum operating pressure	0.7 MPa					
Minimum operating pressure	0.23 MPa	0.18 MPa		0.16 MPa		
Ambient and fluid temperature	Without auto switch: -10 to 70°C (No freezing) With auto switch: -10 to 60°C (No freezing)					
Lubrication	Non-lube					
Piston speed	50 to 500 mm/s					
Cushion ^{Note 1)}	Rubber bumper on both ends					
Rod end thread	Male thread					
Stroke length tolerance	$\begin{matrix} +1.0 \\ 0 \end{matrix}$ mm					
Rod non-rotating accuracy ^{Note 2)}	±0.8°			±0.5°		

Note 1) ø6: With auto switch, single rubber bumper

Note 2) No load: Rod at retracted

Symbol

Single acting,
Spring return

Single acting,
Spring extend

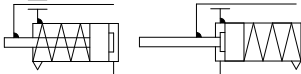

Rubber bumper

Standard Stroke

(mm)

Bore size (mm)	Standard stroke (mm)
6, 10, 16, 20, 25, 32	5, 10, 15

Minimum Stroke for Auto Switch Mounting

(mm)

No. of auto switches mounted	Applicable auto switch		
	D-A9□, D-A9□V	D-M9□, D-M9□V	D-M9□W, D-M9□VW
1 pc.	5	5	5
2 pcs.	10	5	10



Made to Order Specifications

[Click here for details](#)

Symbol	Specifications
-XC22	Fluororubber seals
-XC34	Non-rotating plate with workpiece mounting screw (No extended part on the rod end)

Weight/(): Denotes the values with D-A93.

(g)

Model	Stroke (mm)		
	5	10	15
C(D)UK6-□ $\begin{matrix} S \\ T \end{matrix}$	28 (33)	31 (41)	34 (44)
C(D)UK10-□ $\begin{matrix} S \\ T \end{matrix}$	43 (48)	47 (57)	55 (65)
C(D)UK16-□ $\begin{matrix} S \\ T \end{matrix}$	60 (85)	66 (90)	81 (111)
C(D)UK20-□ $\begin{matrix} S \\ T \end{matrix}$	113 (147)	124 (164)	153 (193)
C(D)UK25-□ $\begin{matrix} S \\ T \end{matrix}$	212 (266)	229 (288)	271 (330)
C(D)UK32-□ $\begin{matrix} S \\ T \end{matrix}$	331 (404)	357 (435)	422 (500)

* For the auto switch weight, refer to page 1271.

Tightening Torque

When mounting a CUK single acting series, refer to page 728.

Theoretical Output

Specifications are the same as single acting, spring return/spring extend type (CU series). Refer to page 740.

Spring Reaction Force

Refer to page 1572 (Table (3): Spring Reaction Force).

Auto Switch Mounting Position

For the auto switch mounting position of CDUK series single acting, spring return/spring extend, refer to page 745, since specification are the same as standard type, single acting, spring return/spring extend type.

Allowable Rotational Torque

Make sure that rotational torque is not applied to the piston rod of the CUK series single acting type cylinder. If the rotation torque were applied unavoidably, refer to page 747.

Moisture Control Tube IDK Series



When operating an actuator with a small diameter and a short stroke at a high frequency, the dew condensation (water droplet) may occur inside the piping depending on the conditions. Simply connecting the moisture control tube to the actuator will prevent dew condensation from occurring. For details, refer to the [Web Catalog](#).

CUK Series

Construction

Single acting, Spring return

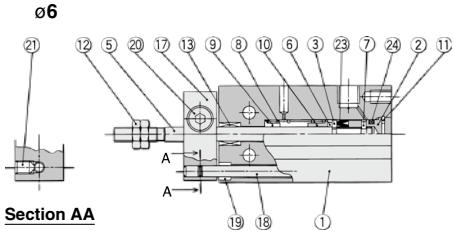

With auto switch

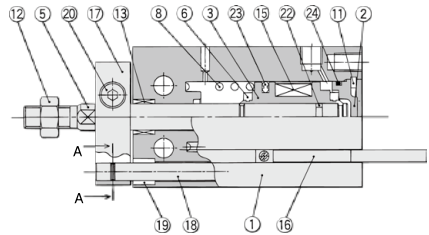
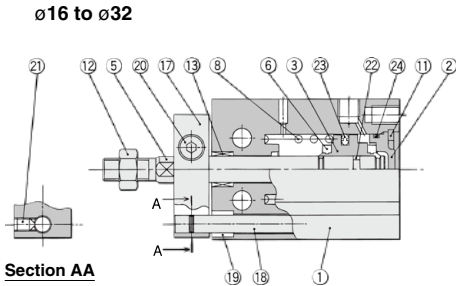
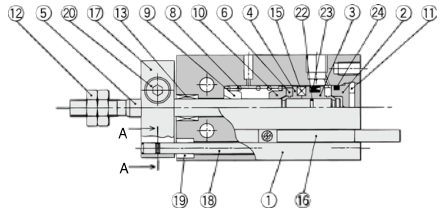
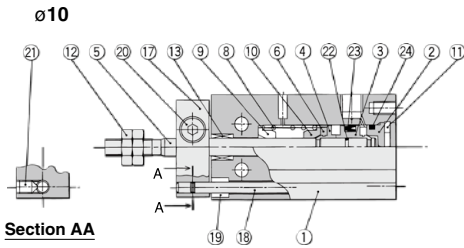
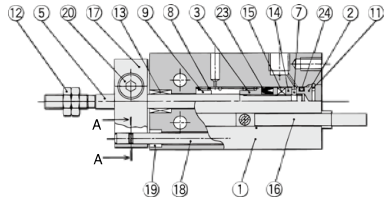

Component Parts

No.	Description	Material	Note
1	Cylinder tube	Aluminum alloy	Hard anodized
2	Head cover	Brass	ø6 to ø10, Electroless nickel plated
		Aluminum alloy	ø16 to ø32, Chromated
3	Piston	Brass	ø6
4	Piston	Aluminum alloy	ø10 to ø32, Chromated
		Aluminum alloy	ø10
5	Piston rod	Stainless steel	
6	Bumper A	Urethane	
7	Bumper B	Urethane	
8	Return spring	Piano wire	Zinc chromated
9	Spring seat	Brass	
10	Spring seat	Brass	

Component Parts

No.	Description	Material	Note
11	Retaining ring	Carbon tool steel	Phosphate coated
12	Rod end nut	Carbon steel	Chromated
13	Bushing	Bearing alloy	
14	Magnet holder	Brass	ø6
15	Magnet	—	
16	Auto switch	—	
17	Non-rotating plate	Aluminum alloy	Nickel plated
18	Guide rod	Stainless steel	
19	Bushing	Bearing alloy	
20	Hexagon socket head cap screw	Carbon steel	Chromated
21	Hexagon socket head set screw	Carbon steel	Chromated
22	Piston gasket		
23*	Piston seal	NBR	
24*	Gasket		

Replacement Parts: Seal Kit

Kit no.	Bore size (mm) / Part no.				
	10	16	20	25	32
	CU10S-PS	CU16S-PS	CU20S-PS	CU25S-PS	CU32S-PS

* Seal kit includes 23, 24. Order the seal kit, based on each bore size.

* Seal kit includes a grease pack (10 g).

Order with the following part number when only the grease pack is needed.

Grease pack part number: GR-S-010 (10 g)

Construction

Single acting, Spring extend

ø6

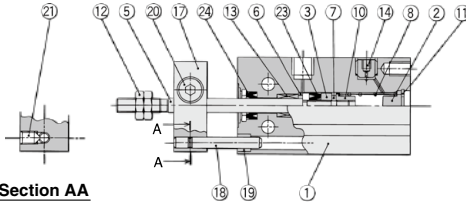

With auto switch

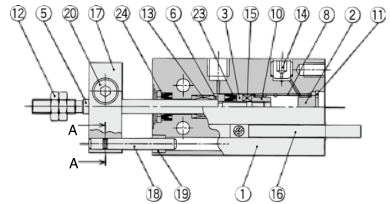

ø10

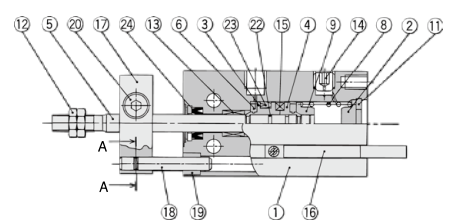
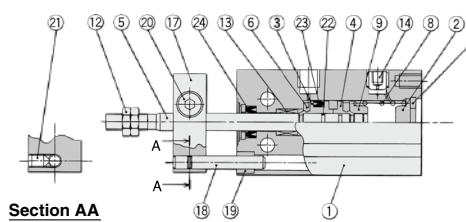

ø16 to ø32

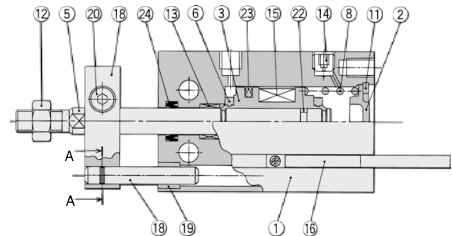
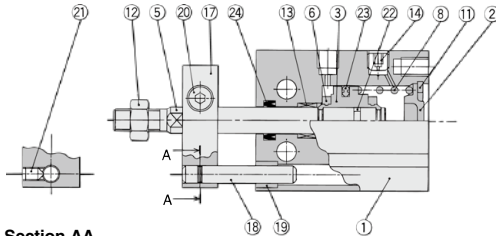

Section AA

Component Parts

No.	Description	Material	Note
1	Cylinder tube	Aluminum alloy	Hard anodized
2	Head cover	Brass	ø6 to ø10, Electroless nickel plated
		Aluminum alloy	ø16 to ø32, Chromated
3	Piston	Brass	ø6
		Aluminum alloy	ø10 to ø32, Chromated
4	Piston	Aluminum alloy	ø10, Chromated
5	Piston rod	Stainless steel	
6	Bumper A	Urethane	
7	Bumper B	Urethane	
8	Return spring	Piano wire	Zinc chromated
9	Spring seat	Brass	
10	Stopper	Brass	ø6
11	Retaining ring	Carbon tool steel	Phosphate coated

Component Parts

No.	Description	Material	Note
12	Rod end nut	Carbon steel	Chromated
13	Bushing	Bearing alloy	
14	Plug with fixed orifice	Alloy steel	Black dyed
15	Magnet	—	
16	Auto switch	—	
17	Non-rotating plate	Aluminum alloy	Nickel plated
18	Guide rod	Stainless steel	
19	Bushing	Bearing alloy	
20	Hexagon socket head cap screw	Carbon steel	Black zinc chromated
21	Hexagon socket head set screw	Carbon steel	Black zinc chromated
22	Piston gasket		
23*	Piston seal	NBR	
24*	Rod seal		

Replacement Parts: Seal Kit

Kit no.	Bore size (mm) / Part no.				
	10	16	20	25	32
	CU10T-PS	CU16T-PS	CU20T-PS	CU25T-PS	CU32T-PS

* Seal kit includes 23, 24. Order the seal kit, based on each bore size.

* Seal kit includes a grease pack (10 g).

Order with the following part number when only the grease pack is needed.

Grease pack part number: GR-S-010 (10 g)

CUK Series

Dimensions: Non-rotating Rod Type; Single Acting, Spring Return

ø6, ø10

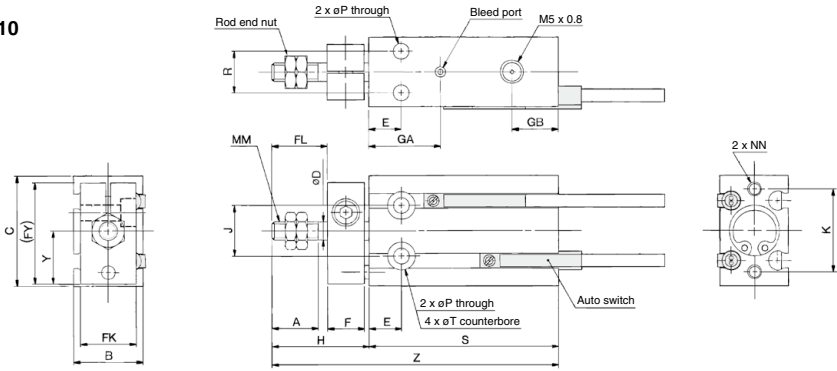

ø16 to ø32

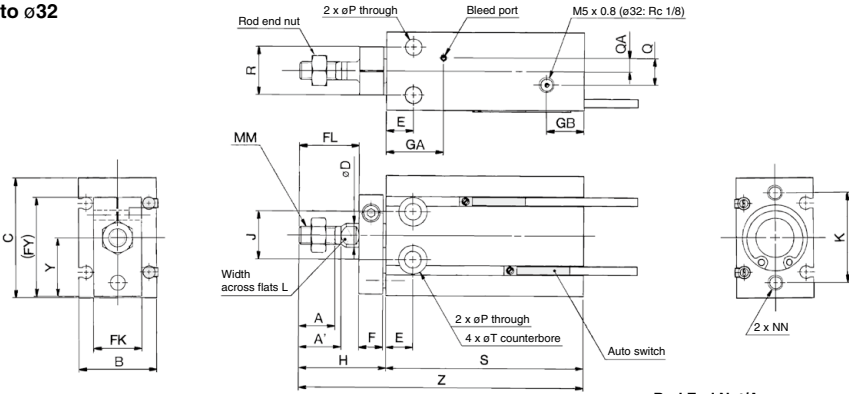

Rod End Nut/Accessory Material: Carbon steel

Part no.	Applicable bore size (mm)	d	H ₁	B ₁	C ₁
NTP-006	6	M3 x 0.5	1.8	5.5	6.4
NTP-010	10	M4 x 0.7	2.4	7	8.1
NTJ-015C	16	M5 x 0.8	4	8	9.2
NT-015A	20	M6 x 1.0	5	10	11.5
NT-02	25	M8 x 1.25	5	13	15.0
NT-03	32	M10 x 1.25	6	17	19.6

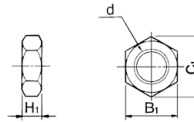

Bore size (mm)	A	A'	B	C	D	E	F	FL	FK	FY	GA	GB	H	J	K	L	MM	NN
6	7	—	13	22	3	7	8	9	11	20.5	15	10	18	10	17	—	M3 x 0.5	M3 x 0.5 depth 5
10	10	—	15	24	4	7	8	12	12	22	16.5	10	21	11	18	—	M4 x 0.7	M3 x 0.5 depth 5
16	11	12.5	20	32	6	7	8	17	13	28	16.5	11.5	26	14	25	5	M5 x 0.8	M4 x 0.7 depth 6
20	12	14	26	40	8	9	8	20	16	33	19	12.5	29	16	30	6	M6 x 1.0	M5 x 0.8 depth 8
25	15.5	18	32	50	10	10	10	22	20	43.5	21.5	13	33	20	38	8	M8 x 1.25	M5 x 0.8 depth 8
32	19.5	22	40	62	12	11	12	29	24	51.5	23	12.5	42	24	48	10	M10 x 1.25	M6 x 1.0 depth 9

Bore size (mm)	P	Q	QA	R	T	Y	Without auto switch						With auto switch					
							S			Z			S			Z		
							5 st	10 st	15 st	5 st	10 st	15 st	5 st	10 st	15 st	5 st	10 st	15 st
6	3.2	—	—	7	6 depth 4.8	10.5	38	43	48	56	61	66	38	43	48	56	61	66
10	3.2	—	—	9	6 depth 5	11.5	41	46	56	62	67	77	41	46	56	62	67	77
16	4.5	4	2	12	7.6 depth 6.5	15.5	35	40	50	61	66	76	45	50	60	71	76	86
20	5.5	9	4.5	16	9.3 depth 8	19.5	41	46	56	70	75	85	51	56	66	80	85	95
25	5.5	9	4.5	20	9.3 depth 9	24.5	45	50	60	78	83	93	55	60	70	88	93	103
32	6.6	13.5	4.5	24	11 depth 11.5	30.5	47	52	62	89	94	104	57	62	72	99	104	114

Dimensions: Non-rotating Rod Type; Single Acting, Spring Extend

ø6, ø10

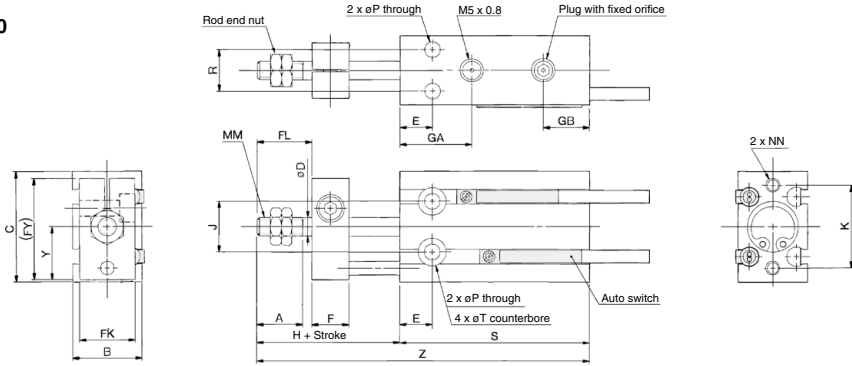

ø16 to ø32

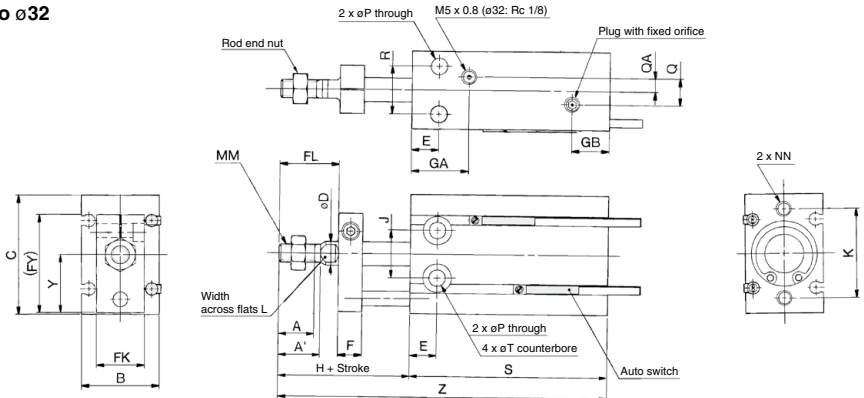

Rod End Nut/Accessory Material: Carbon steel

Part no.	Applicable bore size (mm)	d	H ₁	B ₁	C ₁
NTP-006	6	M3 x 0.5	1.8	5.5	6.4
NTP-010	10	M4 x 0.7	2.4	7	8.1
NTJ-015C	16	M5 x 0.8	4	8	9.2
NT-015A	20	M6 x 1.0	5	10	11.5
NT-02	25	M8 x 1.25	5	13	15.0
NT-03	32	M10 x 1.25	6	17	19.6

Bore size (mm)	A	A'	B	C	D	E	F	FL	FK	FY	GA	GB	H	J	K	L	MM	NN
6	7	—	13	22	3	7	8	9	11	20.5	15	10	18	10	17	—	M3 x 0.5	M3 x 0.5 depth 5
10	10	—	15	24	4	7	8	12	12	22	16.5	10	21	11	18	—	M4 x 0.7	M3 x 0.5 depth 5
16	11	12.5	20	32	6	7	8	17	13	28	16.5	11.5	26	14	25	5	M5 x 0.8	M4 x 0.7 depth 6
20	12	14	26	40	8	9	8	20	16	33	19	12.5	29	16	30	6	M6 x 1.0	M5 x 0.8 depth 8
25	15.5	18	32	50	10	10	10	22	20	43.5	21.5	13	33	20	38	8	M8 x 1.25	M5 x 0.8 depth 8
32	19.5	22	40	62	12	11	12	29	24	51.5	23	12.5	42	24	48	10	M10 x 1.25	M6 x 1.0 depth 9

Bore size (mm)	P	Q	QA	R	T	Y	Without auto switch						With auto switch					
							S			Z			S			Z		
							5 st	10 st	15 st	5 st	10 st	15 st	5 st	10 st	15 st	5 st	10 st	15 st
6	3.2	—	—	7	6 depth 4.8	10.5	38	43	48	61	71	81	38	43	48	61	71	81
10	3.2	—	—	9	6 depth 5	11.5	41	46	56	67	77	92	41	46	56	67	77	92
16	4.5	4	2	12	7.6 depth 6.5	15.5	45	50	60	76	86	101	45	50	60	76	86	101
20	5.5	9	4.5	16	9.3 depth 8	19.5	41	46	56	75	85	100	51	56	66	85	95	110
25	5.5	9	4.5	20	9.3 depth 9	24.5	45	50	60	83	93	108	55	60	70	93	103	118
32	6.6	13.5	4.5	24	11 depth 11.5	30.5	47	52	62	94	104	119	57	62	72	104	114	129

Free Mount Cylinder: Long Stroke Type Double Acting, Single Rod

CU Series

ø6, ø10, ø16, ø20, ø25, ø32

How to Order

With auto switch **CDU 6** [] - **60** **D** - [] - []

Built-in magnet

Bore size

6	6 mm
10	10 mm
16	16 mm
20	20 mm
25	25 mm
32	32 mm

Port thread type

Symbol	Type	Bore size
Nil	M5 x 0.8	ø6, ø10, ø16, ø20, ø25
	Rc 1/8	ø32
TN	NPT 1/8	ø32
TF	G 1/8	ø32

Action

D	Double acting
---	---------------

Long stroke (mm)

ø6, ø10, ø16	40, 50, 60
ø20, ø25, ø32	60, 70, 80, 90, 100

Auto switch

Nil	Without auto switch
-----	---------------------

Number of auto switches

Nil	2 pcs.
S	1 pc.

Made to Order
* Refer to page 761 for the Made to Order specifications.

Built-in Magnet Cylinder Model
If a built-in magnet cylinder without an auto switch is required, there is no need to enter the symbol for the auto switch.
(Example): CDU20-80D

Applicable Auto Switches/Refer to pages 1271 to 1365 for further information on auto switches.

Type	Special function	Electrical entry	Indicator light	Wiring (Output)	Load voltage		Auto switch model		Lead wire length (m)				Pre-wired connector	Applicable load
					DC	AC	Perpendicular	In-line	0.5 (Nil)	1 (M)	3 (L)	5 (Z)		
Solid state auto switch	—	Grommet	Yes	3-wire (NPN)	5 V, 12 V	—	M9NV	M9N	●	●	○	○	IC circuit	Relay, PLC
				3-wire (PNP)			M9PV	M9P	●	●	○	○		
				2-wire	M9BV	M9B	●	●	○	○				
				—	—	—	—	—	—	—	—			
	Diagnostic indication (2-color indicator)	Grommet	Yes	3-wire (NPN)	5 V, 12 V	—	M9NWV	M9NW	●	●	○	○	IC circuit	
				3-wire (PNP)			M9P WV	M9P W	●	●	○	○		
				2-wire	M9B WV	M9B W	●	●	○	○				
				—	—	—	—	—	—	—	—			
Water resistant (2-color indicator)	Grommet	Yes	3-wire (NPN)	5 V, 12 V	—	M9NAV ^{*1}	M9NA ^{*1}	○	○	●	○	IC circuit		
			3-wire (PNP)			M9PAV ^{*1}	M9PA ^{*1}	○	○	●	○			
			2-wire	M9BAV ^{*1}	M9BA ^{*1}	○	○	●	○					
			—	—	—	—	—	—	—	—				
Reed auto switch	—	Grommet	Yes	3-wire (NPN equivalent)	—	—	A96V	A96	●	●	—	—	IC circuit	
				—	—	—	A93V ^{*2}	A93	●	—	●	—		
				2-wire	24 V	12 V	100 V or less	A90V	A90	●	—	●		—

*1 Water resistant type auto switches can be mounted on the above models, but in such case SMC cannot guarantee water resistance.

Consult with SMC regarding water resistant types with the above model numbers.

*2 1 m type lead wire is only applicable to D-A93.

* Lead wire length symbols: 0.5 m Nil (Example) M9NW
 1 m M (Example) M9NWM
 3 m L (Example) M9NWL
 5 m Z (Example) M9NWX

* Solid state auto switches marked with "○" are produced upon receipt of order.

* Since there are applicable auto switches other than the above, refer to page 782 for details.

* For detail about auto switches with pre-wired connector, refer to pages 1340 and 1341.

* Auto switches are shipped together but not assembled.

Free Mount Cylinder: Long Stroke Type Double Acting, Single Rod **CU Series**



Symbol

Double acting, Spring rod, Rubber bumper



Made to Order Specifications

[Click here for details](#)

Symbol	Specifications
-XB6	Heat resistant (-10 to 150°C)
-XB7	Cold resistant (-40 to 70°C)
-XB9	Low speed (10 to 50 mm/s)
-XB13	Low speed (5 to 50 mm/s)
-XC19	Intermediate stroke (5 mm spacer)
-XC22	Fluororubber seals

Moisture Control Tube IDK Series



When operating an actuator with a small diameter and a short stroke at a high frequency, the dew condensation (water droplet) may occur inside the piping depending on the conditions.

Simply connecting the moisture control tube to the actuator will prevent dew condensation from occurring. For details, refer to the [Web Catalog](#).

Specifications

Bore size (mm)	6	10	16	20	25	32
Fluid	Air					
Proof pressure	1.05 MPa					
Maximum operating pressure	0.7 MPa					
Minimum operating pressure	0.12 MPa	0.06 MPa	0.05 MPa			
Ambient and fluid temperature	Without auto switch: -10 to 70°C (No freezing) With auto switch: -10 to 60°C (No freezing)					
Lubrication	Non-lube					
Piston speed	50 to 500 mm/s					
Cushion	Rubber bumper					
Rod end thread	Male thread					
Stroke length tolerance	$\begin{matrix} +1.0 \\ 0 \end{matrix}$ mm					

Standard Stroke

Bore size (mm)	Standard stroke (mm)
6, 10, 16	40, 50, 60
20, 25, 32	60, 70, 80, 90, 100

Weight/(): Denotes the values with D-A93.

(g)

Model	Stroke (mm)						
	40	50	60	70	80	90	100
C(D)U6-□D	43 (53)	49 (59)	55 (65)	—	—	—	—
C(D)U10-□D	64 (74)	72 (82)	80 (90)	—	—	—	—
C(D)U16-□D	92 (122)	104 (134)	116 (146)	—	—	—	—
C(D)U20-□D	—	—	216 (253)	238 (275)	260 (297)	282 (319)	304 (341)
C(D)U25-□D	—	—	363 (422)	397 (456)	431 (490)	465 (524)	499 (558)
C(D)U32-□D	—	—	526 (604)	574 (652)	622 (700)	670 (748)	718 (796)

* For the auto switch weight, refer to page 1271.

Auto Switch Mounting Position

For the auto switch mounting position of CDU long stroke series, refer to page 732, since specifications are the same as standard type, double acting, single rod type.

Tightening Torque

Refer to page 728 for mounting a long stroke type.

Theoretical Output

Specifications are the same as CU series double acting, single rod. Refer to page 728.

Construction

ø6

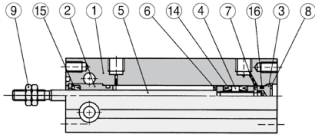

ø10

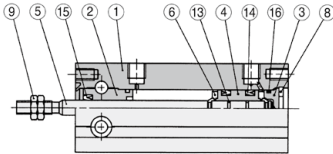

ø16 to ø32

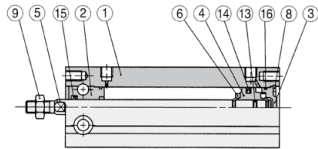

With auto switch

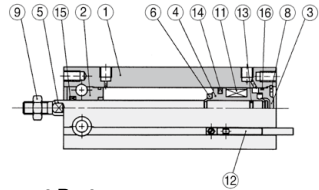
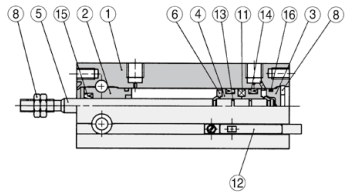
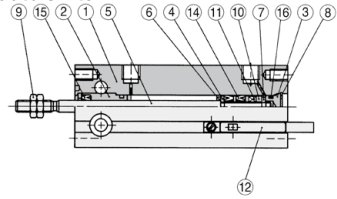

Component Parts

No.	Description	Material	Note
1	Cylinder tube	Aluminum alloy	Hard anodized
2	Rod cover	Aluminum alloy	Hard anodized
3	Head cover	Brass	ø6 to ø10, Electroless nickel plated
		Aluminum alloy	ø16 to ø32, Chromated
4	Piston	Brass	ø6
		Aluminum alloy	ø10 to ø32, Chromated
5	Piston rod	Stainless steel	
6	Bumper A	Urethane	
7	Bumper B	Urethane	

Component Parts

No.	Description	Material	Note
8	Retaining ring	Carbon tool steel	Phosphate coated
9	Rod end nut	Carbon steel	Chromated
10	Magnet holder	Brass	ø6
11	Magnet	—	
12	Auto switch	—	
13	Piston gasket		
14*	Piston seal	NBR	
15*	Rod seal		
16*	Gasket		

Replacement Parts: Seal Kit

Bore size (mm)	Kit no.	Contents
10	CU10D-PS	Set of nos. above 14, 15, 16.
16	CU16D-PS	
20	CU20D-PS	
25	CU25D-PS	
32	CU32D-PS	

* Seal kit includes 14, 15, 16. Order the seal kit, based on each bore size.

* Seal kit includes a grease pack (10 g).

Order with the following part number when only the grease pack is needed.

Grease pack part number: GR-S-010 (10 g)

Dimensions: Double Acting, Single Rod

ø6, ø10

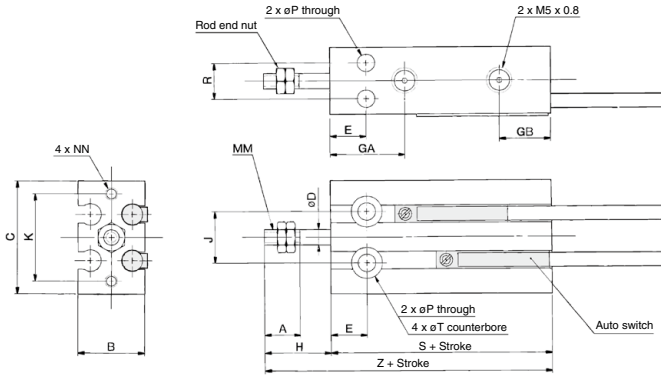

ø16 to ø32

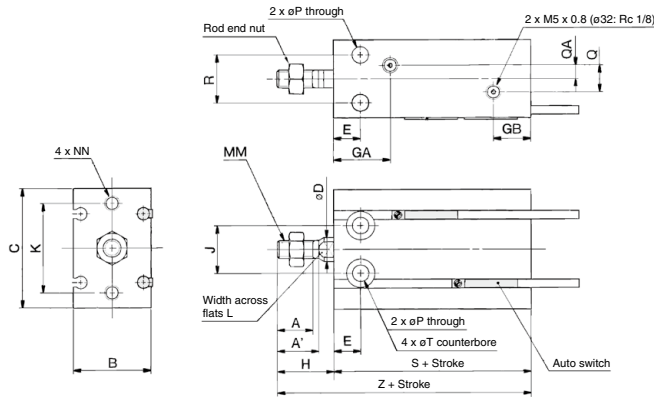

Rod End Nut/Accessory

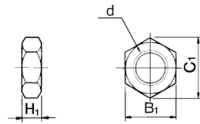

Material: Carbon steel

Part no.	Applicable bore (mm)	d	H ₁	B ₁	C ₁
NTP-006	6	M3 x 0.5	1.8	5.5	6.4
NTP-010	10	M4 x 0.7	2.4	7	8.1
NTJ-015C	16	M5 x 0.8	4	8	9.2
NT-015A	20	M6 x 1.0	5	10	11.5
NT-02	25	M8 x 1.25	5	13	15.0
NT-03	32	M10 x 1.25	6	17	19.6

Bore size (mm)	A	A'	B	C	D	E	GA	GB	H	J	K	L	MM	NN	P	Q	QA
	6	7	—	13	22	3	7	15	10	13	10	17	—	M3 x 0.5	M3 x 0.5 depth 5	3.2	—
10	10	—	15	24	4	7	16.5	10	16	11	18	—	M4 x 0.7	M3 x 0.5 depth 5	3.2	—	—
16	11	12.5	20	32	6	7	16.5	11.5	16	14	25	5	M5 x 0.8	M4 x 0.7 depth 6	4.5	4	2
20	12	14	26	40	8	9	19	12.5	19	16	30	6	M6 x 1.0	M5 x 0.8 depth 8	5.5	9	4.5
25	15.5	18	32	50	10	10	21.5	13	23	20	38	8	M8 x 1.25	M5 x 0.8 depth 8	5.5	9	4.5
32	19.5	22	40	62	12	11	23	12.5	27	24	48	10	M10 x 1.25	M6 x 1.0 depth 9	6.6	13.5	4.5

Bore size (mm)	R	T	Without auto switch		With auto switch	
			S	Z	S	Z
6	7	6 depth 4.8	33	46	33	46
10	9	6 depth 5	36	52	36	52
16	12	7.6 depth 6.5	30	46	40	56
20	16	9.3 depth 8	36	55	46	65
25	20	9.3 depth 9	40	63	50	73
32	24	11 depth 11.5	42	69	52	79

Free Mount Cylinder: Long Stroke Type Non-rotating Rod, Double Acting, Single Rod

CUK Series

ø6, ø10, ø16, ø20, ø25, ø32

How to Order

With auto switch CUK 6 [] - 60 D - []

CDUK 6 [] - 60 D - M9BW [] - []

Built-in magnet

Non-rotating rod type

Bore size

6	6 mm
10	10 mm
16	16 mm
20	20 mm
25	25 mm
32	32 mm

Port thread type

Symbol	Type	Bore size
Nil	M5 x 0.8 Rc 1/8	ø6, ø10, ø16, ø20, ø25
TN	NPT 1/8	ø32
TF	G 1/8	ø32

Action

D	Double acting
---	---------------

Cylinder stroke (mm)

ø6, ø10, ø16	40, 50, 60
ø20, ø25, ø32	60, 70, 80, 90, 100

Auto switch

Nil	Without auto switch
-----	---------------------

* Refer to the table below for applicable auto switches.

Number of auto switches

Nil	2 pcs.
S	1 pc.

Made to Order
* Refer to page 765 for the Made to Order specifications.

Built-in Magnet Cylinder Model
If a built-in magnet cylinder without an auto switch is required, there is no need to enter the symbol for the auto switch.
(Example): CDUK20-80D

Applicable Auto Switches

Refer to pages 1271 to 1365 for further information on auto switches.

Type	Special function	Electrical entry	Indicator light	Wiring (Output)	Load voltage		Auto switch model		Lead wire length (m)				Pre-wired connector	Applicable load	
					DC	AC	Perpendicular	In-line	0.5 (Nil)	1 (M)	3 (L)	5 (Z)			
Solid state auto switch	—	Grommet	Yes	3-wire (NPN)	24 V	—	M9NV	M9N	●	●	○	○	IC circuit	Relay, PLC	
				3-wire (PNP)			M9PV	M9P	●	●	○	○			
				2-wire			M9BV	M9B	●	●	○	○			
	3-wire (NPN)			M9NWV			M9NW	●	●	○	○	IC circuit			
	3-wire (PNP)			M9PWV			M9PW	●	●	○	○	IC circuit			
	2-wire			M9B WV			M9B W	●	●	○	○	—			
Water resistant (2-color indicator)	Grommet	Yes	3-wire (NPN)	24 V	—	5 V, 12 V	M9NAV ^{*1}	M9NA ^{*1}	○	○	○	○	IC circuit	Relay, PLC	
			3-wire (PNP)				M9PAV ^{*1}	M9PA ^{*1}	○	○	○	○	IC circuit		
			2-wire				M9BAV ^{*1}	M9BA ^{*1}	○	○	●	○	—		
Reed auto switch	—	Grommet	Yes	3-wire (NPN equivalent)	24 V	12 V	100 V	A96V	A96	●	—	●	—	IC circuit	—
				No				2-wire	100 V or less	A93V ^{*2}	A93	●	●	●	
								A90V	A90	●	—	●	—	IC circuit	

*1 Water resistant type auto switches can be mounted on the above models, but in such case SMC cannot guarantee water resistance.

Consult with SMC regarding water resistant types with the above model numbers.

*2 1 m type lead wire is only applicable to D-A93.

* Lead wire length symbols: 0.5 m Nil (Example) M9NW
1 m M (Example) M9NWM
3 m L (Example) M9NWL
5 m Z (Example) M9NWX

* Solid state auto switches marked with "○" are produced upon receipt of order.

* Since there are applicable auto switches other than the above, refer to page 782 for details.

* For detail about auto switches with pre-wired connector, refer to pages 1340 and 1341.

* Auto switches are shipped together but not assembled.

Free Mount Cylinder: Long Stroke Type Non-rotating Rod, Double Acting, Single Rod **CUK Series**



Specifications

Bore size (mm)	6	10	16	20	25	32
Fluid	Air					
Proof pressure	1.05 MPa					
Maximum operating pressure	0.7 MPa					
Minimum operating pressure	0.15 MPa	0.10 MPa	0.10 MPa	0.08 MPa		
Ambient and fluid temperature	Without auto switch: -10 to 70°C (No freezing) With auto switch: -10 to 60°C (No freezing)					
Lubrication	Non-lube					
Piston speed	50 to 500 mm/s					
Cushion	Rubber bumper					
Rod end thread	Male thread					
Stroke length tolerance	$^{+1.0}_0$ mm					
Rod non-rotating accuracy (Note)	±0.8°			±0.5°		

Note) No load: Rod at retracted

Symbol

Double acting, Single rod, Rubber bumper

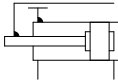

Standard Stroke

(mm)

Bore size (mm)	Standard stroke (mm)
6, 10, 16	40, 50, 60
20, 25, 32	60, 70, 80, 90, 100

Weight/(): Denotes the values with D-A93.

(g)

Model	Stroke (mm)						
	40	50	60	70	80	90	100
C(D)UK6-□D	49 (59)	55 (65)	61 (71)	—	—	—	—
C(D)UK10-□D	71 (81)	79 (89)	87 (97)	—	—	—	—
C(D)UK16-□D	102 (132)	114 (144)	126 (156)	—	—	—	—
C(D)UK20-□D	—	—	243 (284)	267 (308)	291 (332)	315 (356)	339 (380)
C(D)UK25-□D	—	—	405 (460)	440 (495)	475 (530)	510 (565)	545 (600)
C(D)UK32-□D	—	—	617 (695)	669 (747)	721 (799)	773 (851)	825 (903)

* For the auto switch weight, refer to page 1271.



Made to Order Specifications

[Click here for details](#)

Symbol	Specifications
-XB6	Heat resistant (-10 to 150°C)
-XB7	Cold resistant (-40 to 70°C)
-XB9	Low speed (10 to 50 mm/s)
-XB13	Low speed (5 to 50 mm/s)
-XC19	Intermediate stroke (5 mm spacer)
-XC22	Fluororubber seals
-XC34	Non-rotating plate with workpiece mounting screw (No extended part on the rod end)

Allowable Rotational Torque

Make sure that rotational torque is not applied to the piston rod of a long stroke type cylinder. If the rotation torque were applied unavoidably, refer to page 747 for details.

Tightening Torque

When mounting a CUK long stroke series, refer to page 728.

Theoretical Output

Specifications are the same as CU series double acting, single rod. Refer to page 728.

Auto Switch Mounting Position

For the auto switch mounting position of CDUK long stroke series, refer to page 732, since specifications are the same as standard type, double acting, single rod type.

Moisture Control Tube IDK Series



When operating an actuator with a small diameter and a short stroke at a high frequency, the dew condensation (water droplet) may occur inside the piping depending on the conditions.

Simply connecting the moisture control tube to the actuator will prevent dew condensation from occurring. For details, refer to the [Web Catalog](#).

CUK Series

Construction

ø6

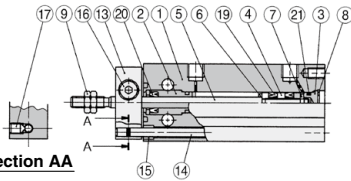

Section AA

ø10

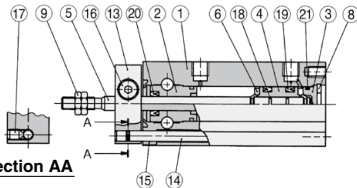

Section AA

ø16 to ø32

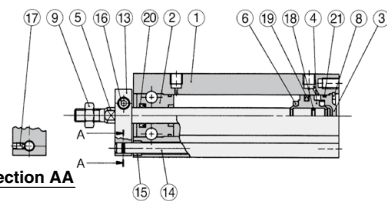

Section AA

With auto switch

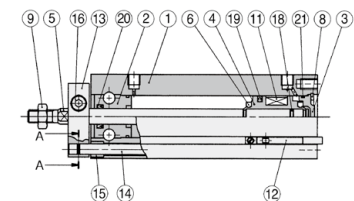
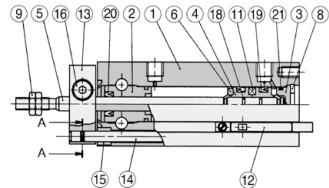
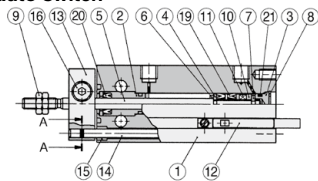

Component Parts

No.	Description	Material	Note
1	Cylinder tube	Aluminum alloy	Hard anodized
2	Rod cover	Aluminum alloy	Hard anodized
3	Head cover	Brass	ø6 to ø10, Electroless nickel plated
		Aluminum alloy	ø16 to ø32, Chromated
4	Piston	Brass	ø6
		Aluminum alloy	ø10 to ø32, Chromated
5	Piston rod	Stainless steel	
6	Bumper A	Urethane	
7	Bumper B	Urethane	
8	Retaining ring	Carbon tool steel	Phosphate coated
9	Rod end nut	Carbon steel	Chromated
10	Magnet holder	Brass	ø6

Component Parts

No.	Description	Material	Note
11	Magnet	—	
12	Auto switch	—	
13	Non-rotating plate	Aluminum alloy	Nickel plated
14	Guide rod	Stainless steel	
15	Bushing	Bearing alloy	
16	Hexagon socket head cap screw	Carbon steel	Chromated
17	Hexagon socket head set screw	Carbon steel	Chromated
18	Piston gasket	NBR	
19	Piston seal		
20	Rod seal		
21	Gasket		

Replacement Parts: Seal Kit

Bore size (mm)	Kit no.	Contents
10	CU10D-PS	Set of nos. above 19, 20, 21.
16	CU16D-PS	
20	CU20D-PS	
25	CU25D-PS	
32	CU32D-PS	

* Seal kit includes 19, 20, 21. Order the seal kit, based on each bore size.

* Seal kit includes a grease pack (10 g).

Order with the following part number when only the grease pack is needed.

Grease pack part number: GR-S-010 (10 g)

Free Mount Cylinder: Long Stroke Type Non-rotating Rod, Double Acting, Single Rod **CUK Series**

Dimensions: Non-rotating Rod Type; Double Acting, Single Rod

ø6, ø10

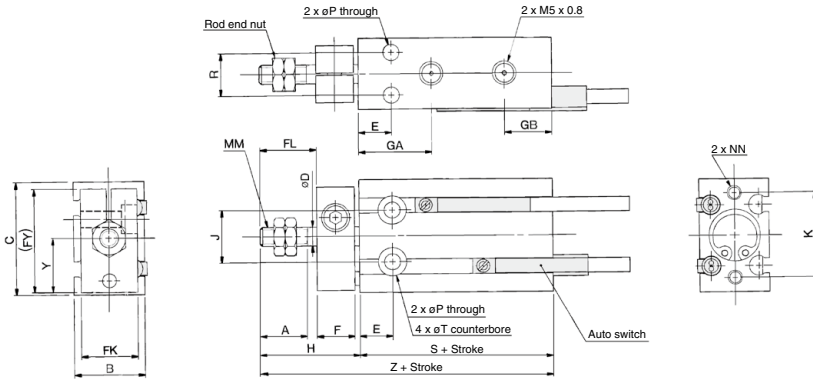

ø16 to ø32

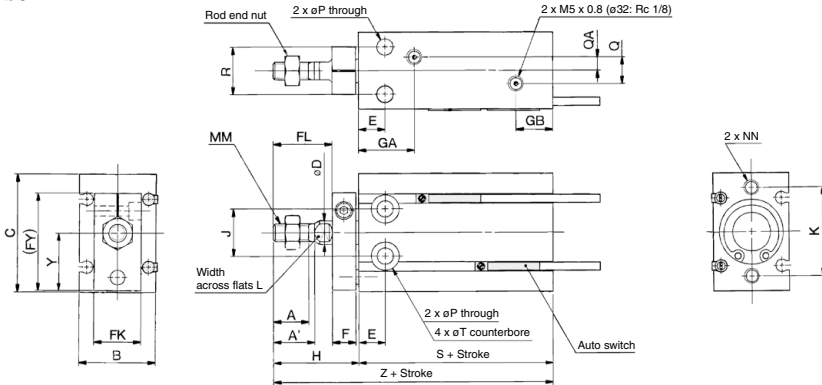

Rod End Nut/Accessory Material: Carbon steel

Part no.	Applicable bore size (mm)	d	H ₁	B ₁	C ₁
NTP-006	6	M3 x 0.5	1.8	5.5	6.4
NTP-010	10	M4 x 0.7	2.4	7	8.1
NTJ-015C	16	M5 x 0.8	4	8	9.2
NT-015A	20	M6 x 1.0	5	10	11.5
NT-02	25	M8 x 1.25	5	13	15.0
NT-03	32	M10 x 1.25	6	17	19.6

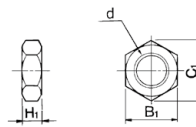

Bore size (mm)	A	A'	B	C	D	E	F	FL	FK	FY	GA	GB	H	J	K	L	MM
6	7	—	13	22	3	7	8	9	11	20.5	15	10	18	10	17	—	M3 x 0.5
10	10	—	15	24	4	7	8	12	12	22	16.5	10	21	11	18	—	M4 x 0.7
16	11	12.5	20	32	6	7	8	17	13	28	16.5	11.5	26	14	25	5	M5 x 0.8
20	12	14	26	40	8	9	8	20	16	33	19	12.5	29	16	30	6	M6 x 1.0
25	15.5	18	32	50	10	10	10	22	20	43.5	21.5	13	33	20	38	8	M8 x 1.25
32	19.5	22	40	62	12	11	12	29	24	51.5	23	12.5	42	24	48	10	M10 x 1.25

Bore size (mm)	NN	P	Q	QA	R	T	Y	Without auto switch		With auto switch	
								S	Z	S	Z
6	M3 x 0.5 depth 5	3.2	—	—	7	6 depth 4.8	10.5	33	51	33	51
10	M3 x 0.5 depth 5	3.2	—	—	9	6 depth 5	11.5	36	57	36	57
16	M4 x 0.7 depth 6	4.5	4	2	12	7.6 depth 6.5	15.5	30	56	40	66
20	M5 x 0.8 depth 8	5.5	9	4.5	16	9.3 depth 8	19.5	36	65	46	75
25	M5 x 0.8 depth 8	5.5	9	4.5	20	9.3 depth 9	24.5	40	73	50	83
32	M6 x 1.0 depth 9	6.6	13.5	4.5	24	11 depth 11.5	30.5	42	84	52	94

Free Mount Cylinder with Air Cushion

CU Series

New air cushion mechanism



Extended dimensions (compared to the standard CU models) are hardly noticeable.

(with rubber bumper)

- Overall length: **+1.5 to 7 mm**
- Overall height: **+0 to 2 mm**
No air cushion protrusion.
- Overall width: not affected

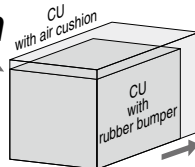

Bore size	Extended dimensions (mm)	
	Length	Height
ø20	7	2
ø25	1.5	0
ø32	4	0

Unique air cushion construction requires no cushion ring.

Working principle

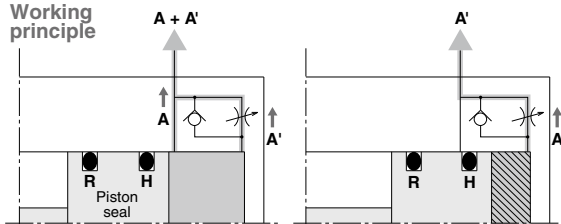

- ① When the piston is retracting, air is exhausted through both A and A' until piston seal H passes air passage A.
- ② After piston seal H has passed air passage A, air is exhausted only through A'. The section marked with slanted lines becomes a cushion chamber, and an air cushion effect is achieved.
- ③ When air is supplied for the piston extension, the check valve opens and the piston extends with no delay.

Free mounting

3 types of mounting orientations can be accommodated depending on the installation conditions.

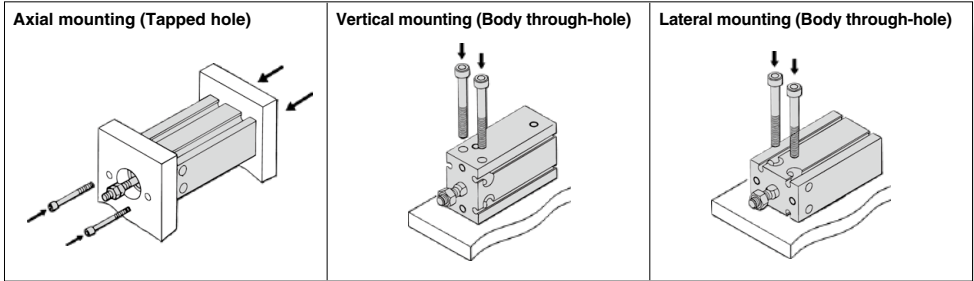

Approximately 2.4 times of allowable kinetic energy

(Compared to the old CU series with rubber bumper)

Improved allowable kinetic energy absorption.

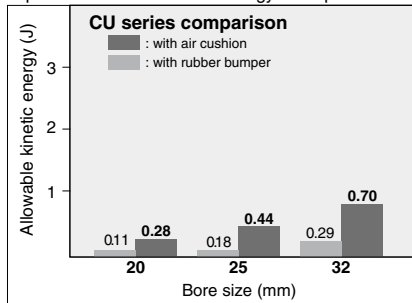

Improved sound insulation (Reduced impact noise at the stroke end)

- Noise reduction of more than 11 dB is possible (compared to the CU20 series with rubber bumper).

Interchangeable mounting

Mounting dimensions (J, K, R, and E) are the same as the rubber bumper type CU series.

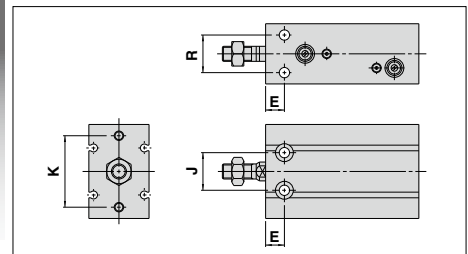

Improved repeatability

When compared to rubber bumper type actuators, air cushion type cylinders are less likely to be affected by pressure fluctuations, and therefore better able to achieve a stable and smooth stroke.

Size Variations

Model	Standard stroke									Auto switch
	20	30	40	50	60	70	80	90	100	
C(D)U20	●	●	●	●	●	●	●	●	●	<ul style="list-style-type: none"> • $\phi 20$ to $\phi 32$ • Direct mounting type auto switch
C(D)U25	●	●	●	●	●	●	●	●	●	
C(D)U32	●	●	●	●	●	●	●	●	●	

Free Mount Cylinder with Air Cushion

CU Series

ø20, ø25, ø32

How to Order

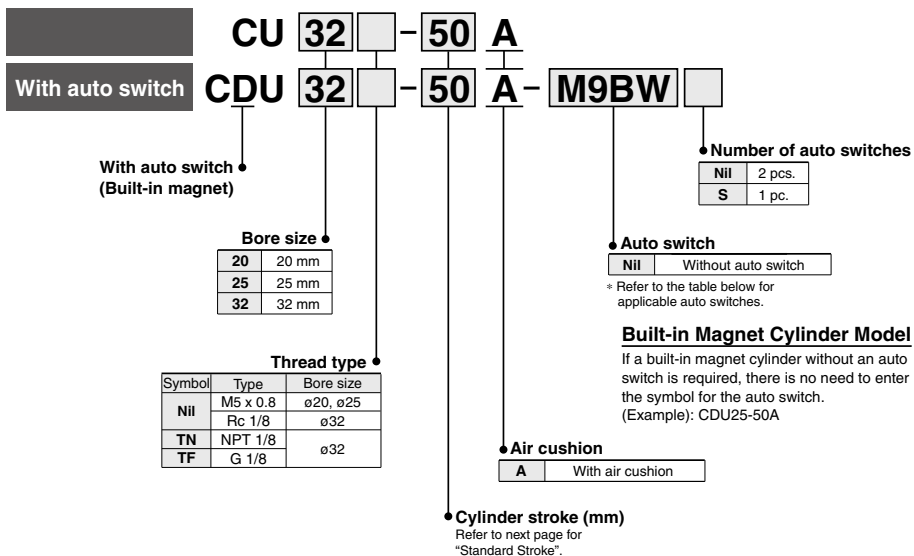

Built-in Magnet Cylinder Model

If a built-in magnet cylinder without an auto switch is required, there is no need to enter the symbol for the auto switch.
(Example): CDU25-50A

Applicable Auto Switches/Refer to pages 1271 to 1403 for further information on auto switches.

Type	Special function	Electrical entry	Polar light	Wiring (Output)	Load voltage		Auto switch model		Lead wire length (m)				Pre-wired connector	Applicable load
					DC	AC	Perpendicular	In-line	0.5 (Nil)	1 (M)	3 (L)	5 (Z)		
Solid state auto switch	—	Grommet	Yes	3-wire (NPN)	5 V, 12 V	—	M9NV	M9N	●	●	●	○	○	IC circuit
				3-wire (PNP)			M9PV	M9P	●	●	●	○	○	
	2-wire			12 V	M9BV	M9B	●	●	●	○	○	—		
	3-wire (NPN)				M9NVW	M9NW	●	●	●	○	○		IC circuit	
	3-wire (PNP)	5 V, 12 V	M9PVW	M9PW	●	●	●	○	○	—				
	2-wire		M9BWW	M9BW	●	●	●	○	○		—			
	Water resistant (2-color indicator)	Grommet	No	3-wire (NPN)	5 V, 12 V	—	M9NAV ^{*1}	M9NA ^{*1}	○	○		○	○	○
				3-wire (PNP)			M9PAV ^{*1}	M9PA ^{*1}	○	○	○	○	○	—
Reed auto switch	—	Grommet	Yes	3-wire (NPN equivalent)	—	5 V	A96V	A96	●	—	●	—	—	
				2-wire			24 V	12 V	A93V ^{*2}	A93	●	●	●	●
				No	2-wire	100 V or less			A90V	A90	●	—	●	—
							—	—	—	—	—	—	—	—

*1 Water resistant type auto switches can be mounted on the above models, but in such case SMC cannot guarantee water resistance.

Consult with SMC regarding water resistant types with the above model numbers.

*2 1 m type lead wire is only applicable to D-A93.

* Lead wire length symbols: 0.5 m Nil (Example) M9NW
1 m M (Example) M9NWM
3 m L (Example) M9NWL
5 m Z (Example) M9NWX

* Solid state auto switches marked with "○" are produced upon receipt of order.

* Since there are applicable auto switches other than the above, refer to page 782 for details.

* For detail about auto switches with pre-wired connector, refer to pages 1340 and 1341.

* Auto switches are shipped together but not assembled.

Specifications



Type	Pneumatic (Non-lube)
Fluid	Air
Proof pressure	1.0 MPa
Maximum operating pressure	0.7 MPa
Minimum operating pressure	0.08 MPa
Ambient and fluid temperature	Without auto switch: -10°C to 70°C (No freezing) With auto switch: -10°C to 60°C (No freezing)
Rod end thread	Male thread
Stroke length tolerance	+1.0 0
Piston speed	50 to 500 mm/s

Effective Cushion Length

Bore size (mm)	20	25	32
Effective cushion length (mm)	6.6	6.7	7.7

Standard Stroke

Bore size (mm)	Standard stroke (mm)
20, 25, 32	20, 30, 40, 50, 60, 70, 80, 90, 100

* Intermediate strokes are also available upon receipt of order. Please contact SMC.
Minimum stroke length is 20 mm.

When mounting the CU series
Tightening Torque refer to the table below.

Bore size (mm)	Hexagon socket head cap screw size	Proper tightening torque (N·m)
20, 25	M5	5.10 ±10%
32	M6	8.04 ±10%

Allowable Kinetic Energy

Refer to "Selection" on page 776 regarding allowable kinetic energy.

Theoretical Output

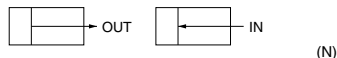

Bore size (mm)	Operating direction	Operating pressure (MPa)		
		0.3	0.5	0.7
20	OUT	94.2	157	220
	IN	79.2	132	185
25	OUT	147	246	344
	IN	124	206	288
32	OUT	241	402	563
	IN	207	346	454

Weight

Basic Weight (g)

Bore size (mm)	Standard stroke (mm)								
	20	30	40	50	60	70	80	90	100
20	186	208	230	252	274	296	318	340	362
25	289	323	357	391	425	459	493	527	561
32	464	512	560	608	656	704	752	800	848

Additional Weight (g)

Bore size (mm)	Magnet
20	5
25	6
32	11

Moisture Control Tube IDK Series



When operating an actuator with a small diameter and a short stroke at a high frequency, the dew condensation (water droplet) may occur inside the piping depending on the conditions.

Simply connecting the moisture control tube to the actuator will prevent dew condensation from occurring. For details, refer to the [Web Catalog](#).

Construction

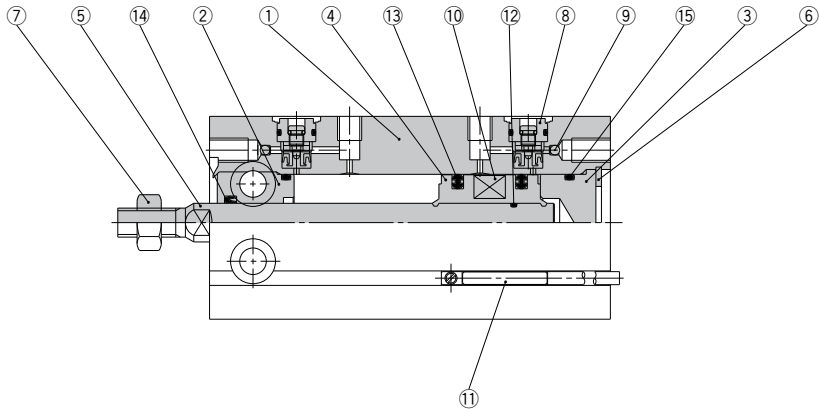

Component Parts

No.	Description	Material	No. of pcs.	Note
1	Cylinder tube	Aluminum alloy	1	Hard anodized
2	Rod cover	Aluminum alloy	1	Hard anodized
3	Head cover	Aluminum alloy	1	Chromated
4	Piston	Aluminum alloy	1	Chromated
5	Piston rod	Stainless steel	1	
6	Retaining ring	Carbon tool steel	1	Phosphate coated
7	Rod end nut	Carbon steel	1	Chromated
8	Cushion needle assembly	—	(2)	
9	Steel ball	Carbon steel	2	
10	Magnet	—	1	
11	Auto switch	—	(2)	
12	Piston gasket	NBR	1	
13	Piston seal	NBR	2	
14	Rod seal	NBR	1	
15	Gasket	NBR	1	

Replacement Parts: Seal Kit

Bore size (mm)	Kit no.	Contents
ø20	CU20A-PS	Set of nos. above 13, 14, 15.
ø25	CU25A-PS	
ø32	CU32A-PS	

* Seal kit includes 13, 14, 15. Order the seal kit, based on each bore size.

* Seal kit includes a grease pack (10 g).
Order with the following part number when only the grease pack is needed.

Grease pack part number: GR-S-010 (10 g)

Dimensions

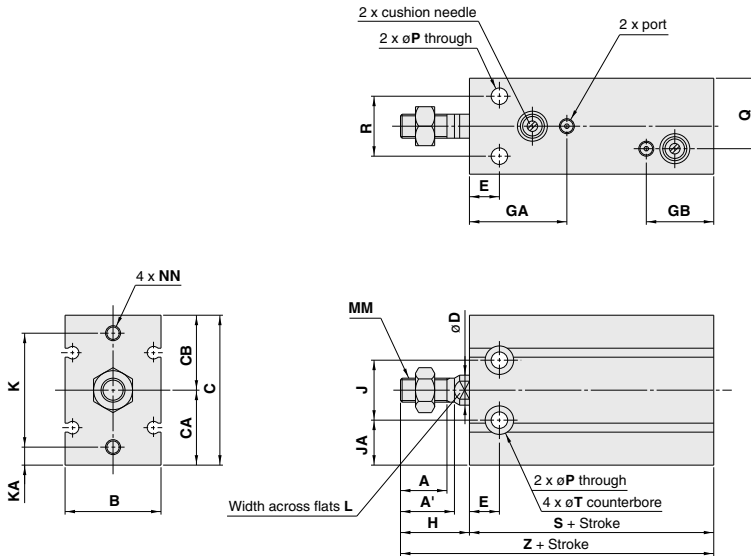

(mm)

Bore size (mm)	Port size	A	A'	B	C	CA	CB	D	E	GA	GB	H	J	JA
20	M5 x 0.8	12	14	26	42	20	22	8	9	29	27	19	16	12
25	M5 x 0.8	15.5	18	32	50	25	25	10	10	32.5	22.5	23	20	15
32	1/8	19.5	22	40	62	31	31	12	11	35	25	27	24	19

Bore size (mm)	K	KA	L	MM	NN	P	Q	R	T	S	Z	Standard stroke
20	30	5	6	M6 x 1.0	M5 x 0.8 depth 8	5.5	13	16	9.3 depth 8	53	72	20, 30, 40, 50, 60, 70, 80, 90, 100
25	38	6	8	M8 x 1.25	M5 x 0.8 depth 8	5.5	23.5	20	9.3 depth 9	51.5	74.5	
32	48	7	10	M10 x 1.25	M6 x 1.0 depth 9	6.6	29	24	11 depth 11.5	56	83	

Rod End Nut/Accessory

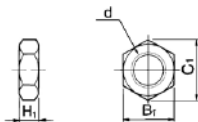

Material: Carbon steel

Part no.	Applicable bore size (mm)	d	H ₁	B ₁	C ₁
NT-015A	20	M6 x 1.0	5	10	11.5
NT-02	25	M8 x 1.25	5	13	15.0
NT-03	32	M10 x 1.25	6	17	19.6

Auto Switch Mounting

Proper Auto Switch Mounting Position (Detection at stroke end) and Its Mounting Height

D-A9□
D-M9□
D-M9□W
D-M9□A

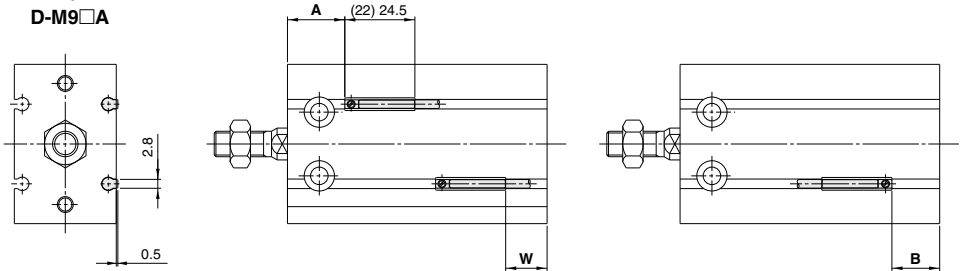

(): Denotes the values of D-A96.

D-A9□V
D-M9□V
D-M9□WV
D-M9□AV

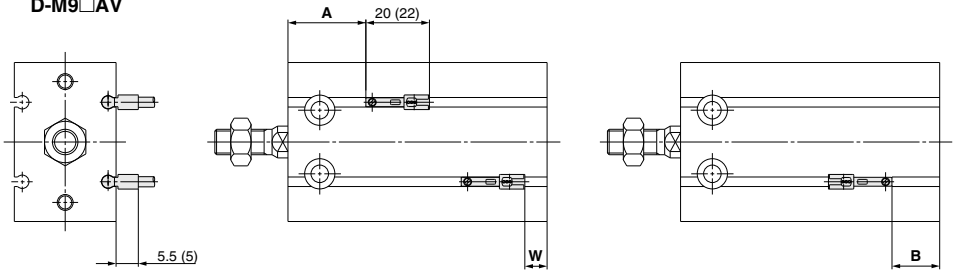

(): Denotes the values of D-M9□V, D-M9□WV.

Bore size (mm)	D-A9□, D-A9□V		D-M9□, D-M9□W			D-M9□V, D-M9□WV			D-M9□A			D-M9□AV			
	A	B	W	A	B	W	A	B	W	A	B	W	A	B	W
20	18	15	13(10.5)	22	19	9	22	19	11	22	19	11	22	19	13
25	20	11	9(6.5)	24.5	15	5	24.5	15	7	24.5	15	7	24.5	15	9
32	22.5	13.5	11.5(9)	26.5	17.5	7.5	26.5	17.5	9.5	26.5	17.5	9.5	26.5	17.5	11.5

(mm)

Note 1) Figures in the table above are used as a reference when mounting the auto switches for stroke end detection.
In the case of actually setting the auto switches, adjust them after confirming their operation.

Note 2) Values in () are dimensions for D-A90 and A93 type.

Operating Range

Switch model	Bore size (mm)		
	20	25	32
D-A9□, A9□V	11	12.5	14
D-M9□, M9□V D-M9□W, M9□WV D-M9□A, M9□AV	7	7	7.5

* Since the operating range is provided as a guideline including hysteresis, it cannot be guaranteed (assuming approximately ±30% dispersion).
It may vary substantially depending on an ambient environment.

Auto Switch Rail Position

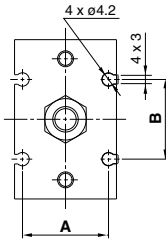

(mm)		
Bore size (mm)	A	B
20	21	23
25	27	25
32	35	27

Caution on Proximity Installation

When free mounting cylinders equipped with auto switches are used, the auto switches could activate unintentionally if the installed distance is less than the dimensions shown in the table. Therefore, make sure to provide a greater clearance. Due to unavoidable circumstances, if they must be used with less distance than the dimensions given in the table, the cylinders must be shielded. Therefore, affix a steel plate or a magnetic shielding plate (MU-S025) to the area on the cylinder that corresponds to the adjacent auto switch. (Please contact SMC for details.) Auto switches may malfunction if a shielding plate is not used.

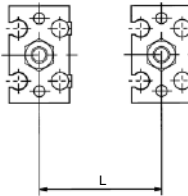

Bore size (mm)	Mounting pitch L (mm)
20	40
25	46
32	56

Dimensions of shielding plate (MU-S025) that is sold separately are indicated as reference.

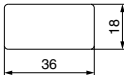

Material: Ferrite stainless steel, Thickness: 0.3 mm
The product can be attached to the cylinder since the bottom side is a seal type.



CU Series Specific Product Precautions

Be sure to read this before handling the products. Refer to page 20 for safety instructions and pages 21 to 30 for actuator and auto switch precautions.

Installation and Removal of Retaining Rings

⚠ Caution

1. Use appropriate pliers (Type C retaining ring installing tool) for installation and removal of retaining rings.
2. Even when using appropriate pliers (Type C retaining ring installing tool), proceed with caution as there is a danger of the retaining ring flying off the end of the pliers (tool) and causing bodily injury or damage to nearby equipment. After installation, make sure that the retaining ring is securely seated into the retaining ring groove before supplying air.

Mounting

⚠ Caution

1. Refer to the below table for mounting cylinders.

Tightening Torque

Bore sizes (mm)	Hexagon socket head cap screw (mm)	Proper tightening torque (N/m)
20, 25	M5	5.10 ±10%
32	M6	8.04 ±10%

Selection

⚠ Caution

1. Operate the cylinder to the stroke end.
When the stroke is restricted by an external stopper or a clamped workpiece, sufficient cushioning and noise reduction may not be achieved.
2. Strictly observe the limiting ranges for load mass and maximum speed (Graph (1)). Also, the limiting ranges provided here are based on the condition that the cylinder is operated to the stroke end with a proper cushion needle adjustment.

If operated beyond the limiting ranges, excessive impact will occur and this may cause damage to equipment.

Graph (1)

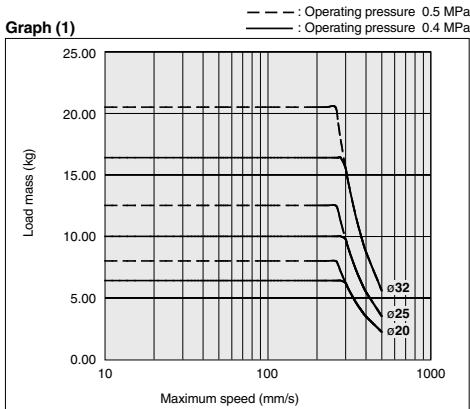

Selection

⚠ Caution

3. Adjust the cushion needle to reduce excessive kinetic energy from the piston impact at the stroke end by allowing it to absorb sufficient kinetic energy during the cushion stroke.

If due to improper adjustment, the piston impacts the stroke end with excessive kinetic energy (values above those given in Table (1)), an excessive impact will occur and this may cause damages to equipment.

Table (1) Allowable Kinetic Energy at Piston Impact (J)

Piston speed	20	25	32
	50 to 500 mm/s		
Allowable kinetic energy	0.055	0.09	0.15

4. Strictly observe the limiting ranges for the piston rod lateral load (Graph (2)).

If operated beyond the limiting ranges, equipment life may be reduced or damage to equipment may occur.

Piston Rod Lateral Load (Graph (2))

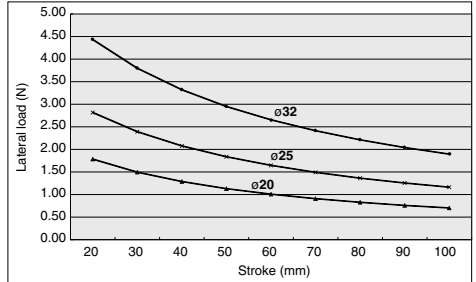

Cushion Needle Adjustment

⚠ Caution

1. Keep the adjustment range for the cushion needle between the fully closed position and the rotations shown below.

	Rotations
ø20 to ø32	2.5 rotations or less

Use a 3 mm flat head watchmakers' screwdriver to adjust the cushion needle. The adjustment range for the cushion needle must be between the fully closed position and the open position ranges indicated in the above table. A retaining mechanism prevents the cushion needle from slipping out; however, it may spring out during operation if it is rotated beyond the ranges shown above.

Free Mount Cylinder for Vacuum

ZCUK Series

A free mount cylinder with a vacuum passage in the rod to meet the requirements for **Air cylinder** + **Vacuum pad**.

A vacuum passage has been provided in the rod of the CUK cylinder to enable a vacuum pad to be installed on the end of the rod.

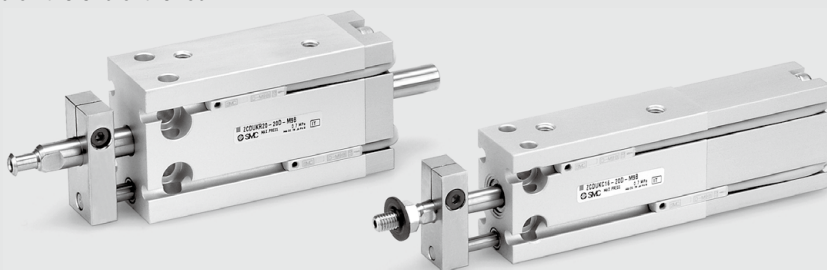

Not necessary to provide vacuum tubing space at the end of the rod.

The area around the vacuum pad is uncluttered.

● Non-rotating rod ●

A guide is provided as standard equipment

Non-rotating rod accuracy (no load: when the rod is retracted on the detent plate side):
 $\phi 10, \phi 16$ $\pm 0.8^\circ$
 $\phi 20, \phi 25, \phi 32$ $\pm 0.5^\circ$

Do not apply a lateral load to the piston rod. Because the piston rod is a hollow rod, a lateral load can cause the piston rod to bend or break.

● Auto switch ●

Reed auto switch:

D-A9□ (Heavy-duty cord, in-line entry)
 D-A9□V (Heavy-duty cord, perpendicular entry)

Solid state auto switch:

D-M9□, D-M9□W (Heavy-duty cord, in-line entry)
 D-M9□V, D-M9□WV (Heavy-duty cord, perpendicular entry)

● Vacuum pad (Pad diameter: $\phi 2$ to $\phi 50$) ●

<Perpendicular female thread>



<Male thread>

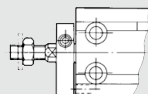

<Direct mounting>

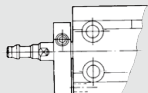

<Barb fitting>

● How to provide piping to the vacuum side

Cap piping

The piston rod of the vacuum side does not protrude. Also, the vacuum outlet tube does not move when the piston is operating.

Vacuum port pressure range: -101 kPa to 0.6 MPa
 Pressurize only when releasing the vacuum. At that time, use it under the cylinder operating pressure.

Rod piping

Lighter weight than the cap piping.

Can also be used for air blowing.

Vacuum port pressure range: -101 kPa to 0.6 MPa



Free Mount Cylinder for Vacuum

ZCUK Series

How to Order

ZCUK C 16 - 20 D

With auto switch **ZCDUK C 16 - 20 D - M9BW**

Number of auto switches:
 Nil 2 pcs.
 S 1 pc.

Acting:
 D Double acting

Auto switch:
 Nil Without auto switch

Refer to the table below for applicable auto switches.

Built-in Magnet Cylinder Model
 If a built-in magnet cylinder without an auto switch is required, there is no need to enter the symbol for the auto switch.
 (Example) ZCDUKC20-20D

Cylinder standard stroke (mm)
 10, 16 5, 10, 15, 20, 25, 30
 20, 25, 32 5, 10, 15, 20, 25, 30, 40, 50

With auto switch
 Built-in magnet
 Type (Tubing method in vacuum side)/(Rod end shape)

Symbol	Type	Bore size
C	Cap piping/Male thread	10 10 mm
D	Cap piping/Pad direct mounting	16 16 mm
Q	Rod piping/Male thread	20 20 mm
R	Rod piping/Pad direct mounting	25 25 mm
		32 32 mm

Port thread type

Symbol	Type	Bore size
Nil	M5 x 0.8	ø10, ø16, ø20, ø25
Nil	Rc1/8	ø32
TN	NPT1/8	ø32
TF (Note)	G1/8	ø32

Note) In the case of rod piping (Q, R), TF (G1/8) is not available.

Applicable Auto Switches/Refer to pages 1271 to 1365 for the detailed specifications on auto switches.

Type	Special function	Electrical entry	Indicator/light	Wiring (Output)	Load voltage		Auto switch model		Lead wire length (m)			Pre-wired connector	Applicable load	
					DC	AC	Perpendicular	In-line	0.5 (Nil)	1 (M)	3 (L)			5 (Z)
Solid state auto switch	—	Grommet	Yes	3-wire (NPN)	5 V, 12 V	—	M9NV	M9N	●	●	○	○	IC circuit	Relay, PLC
				3-wire (PNP)			M9PV	M9P	●	●	○	○		
				2-wire			M9BV	M9B	●	●	○	○		
	Diagnostic indication (2-color indicator)			3-wire (NPN)	5 V, 12 V	M9NWW	M9NW	●	●	○	○	IC circuit		
				3-wire (PNP)		M9PWW	M9PW	●	●	○	○			
				2-wire		M9BWW	M9BW	●	●	○	○			
Water resistant (2-color indicator)	3-wire (NPN)	5V,12V	M9NAV ^{*1}	M9NA ^{*1}	○	○	○	○	IC circuit					
	3-wire (PNP)		M9PAV ^{*1}	M9PA ^{*1}	○	○	○	○						
	2-wire		M9BAV ^{*1}	M9BA ^{*1}	○	○	○	○						
Reed auto switch	—	Grommet	Yes	3-wire (NPN equivalent)	— 5 V	—	A96V	A96	●	●	—	—	IC circuit	Relay, PLC
				2-wire			24 V 12 V	A93V ^{*2}	A93	●	●	●		
			No	2-wire	24 V	100 V 100 V or less	A90V	A90	●	●	—	—	IC circuit	

- *1 Water resistant type auto switches can be mounted on the above models, but in such case SMC cannot guarantee water resistance. Consult with SMC regarding water resistant types with the above model numbers.
 *2 1 m type lead wire is only applicable to D-A93.
 * Lead wire length symbols: 0.5 m..... Nil (Example) M9NW
 1 m..... M (Example) M9NWM
 3 m..... L (Example) M9NWL
 5 m..... Z (Example) M9NWZ
- * Solid state auto switches marked with "○" are produced upon receipt of order.
 * Refer to pages 1340 and 1341 for the details on auto switches with a pre-wired connector.
 * Auto switches are shipped together but not assembled.

How to Order Vacuum Pad

Note) Refer to page 780 for combination of cylinder and pad.

• In the case of rod end male

ZPT 02 U N - B4

Pad dia. (mm)

02	ø2
04	ø4
06	ø6
08	ø8
10	ø10
13	ø13
16	ø16
20	ø20
25	ø25
32	ø32
40	ø40
50	ø50

Vacuum entry (Mounting thread diameter)

Symbol	Thread dia.	ø2 to ø8	ø10 to ø16	ø20 to ø32	ø40, ø50
B4	M4 x 0.7	●	—	—	—
B5	M5 x 0.8	●	—	—	—
B6	M6 x 1	—	●	●	—
B8	M8 x 1.25	—	—	●	●
B10	M10 x 1.25	—	—	●	●

Material

N	NBR
S	Silicone rubber
U	Urethane rubber
F	FKM
GN	Conductive NBR (ø2 to ø16 only)
GS	Conductive silicone rubber (ø2 to ø16 only)

Table (1) Pad Dia./Pad Type

Type	2	4	6	8	10	13	16	20	25	32	40	50
Flat	●	●	●	●	●	●	●	●	●	●	●	●
Flat with ribs	—	—	—	—	●	●	●	●	●	●	●	●
Deep	—	—	—	—	—	—	—	—	—	—	—	—
Bellows	—	—	●	●	●	●	●	●	●	●	●	●

Pad type

Application:
Refer to "Table (1)".

U	Flat
C	Flat with ribs
D	Deep
B	Bellows

• In the case of pad direct mounting

ZP 04 U N - X11

Pad dia. (mm)

02	ø2
04	ø4
06	ø6
08	ø8
10	ø10
13	ø13
16	ø16
20	ø20
25	ø25
32	ø32
40	ø40
50	ø50

Suffix

Symbol	Applicable cylinder model
X11	ZC(D)UK _R 10
Nil	ZC(D)UK _R 16 to 32

Note) -X11 pad: ø2 to ø8 diameter and flat type only.

Material

N	NBR
S	Silicone rubber
U	Urethane rubber
F	FKM
GN	Conductive NBR (ø2 to ø16 only)
GS	Conductive silicone rubber (ø2 to ø16 only)

Pad type

U	Flat
C	Flat with ribs
D	Deep
B	Bellows (Except "-X11")

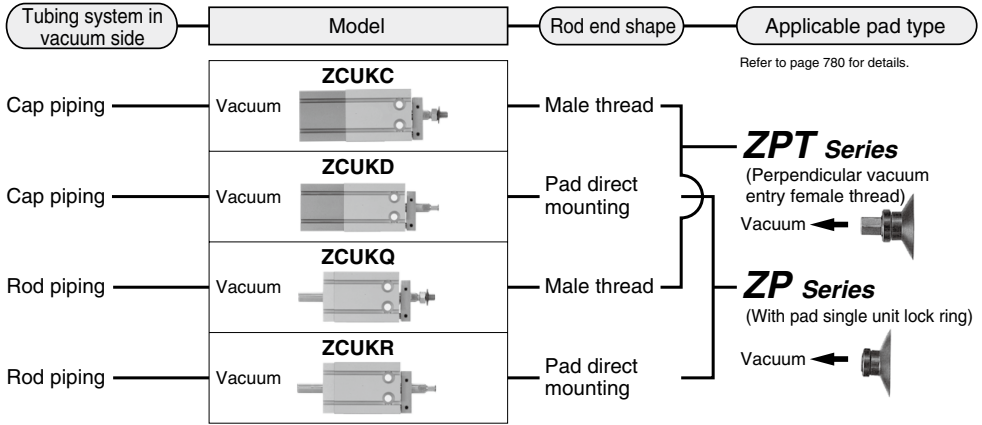

Specifications

Bore size (mm)	ø10	ø16	ø20	ø25	ø32
Fluid	Air				
Proof pressure	1.05 MPa				
Maximum operating pressure	0.7 MPa				
Minimum operating pressure	0.13 MPa		0.11 MPa		
Vacuum port pressure	-101 kPa to 0.6 MPa (At vacuum release 0 to 0.6 MPa) <small>Note</small>				
Ambient and fluid temperature	Without auto switch: -10 to +70°C (No freezing) With auto switch: -10 to +60°C (No freezing)				
Lubrication	Not required				
Piston speed	50 to 500 mm/s				
Cushion	Rubber bumper on both sides				
Stroke allowance	+1.0 0				
Rod tip screw	With or without (Pad direct mounting)				
Mounting	Basic type				
Applicable pad	Refer to page 780 for details.				

Note) For a cap type, supply pressure only when vacuum is released. That pressure should be less than the cylinder pressure.

Non-rotating Rod Accuracy (No load/At retraction of the rod at the locking plate side)

Bore size (mm)	ø10	ø16	ø20	ø25	ø32
Non-rotating rod accuracy	±0.8°		±0.5°		

⚠ Precautions

Be sure to read this before handling the products.

Refer to page 20 for safety instructions and pages 21 to 30 for actuator and auto switch precautions.

⚠ Caution

- Do not place your finger in the clearance between the detent plate and the cylinder tube. Never put your finger between the non-rotating plate and cylinder tube. Your finger may be pinched when the piston rod retracts. If your finger is caught, it could injure your finger because the cylinder outputs a considerable amount of force.
- Make sure that rotational torque is not applied to the piston rod. If this is unavoidable, operate the cylinder within the allowable rotational torque listed in the table below.
- To secure a workpiece to the end of the piston rod, tighten the workpiece onto the piston rod with the piston rod fully retracted so that torque is not applied to the piston rod.
- To install a cylinder, tighten it within the torque values indicated in the table below.

Proper Tightening Torque

Bore size (mm)	Hexagon socket head bolt diameter (mm)	Proper tightening torque (N·m)
ø10	M3	1.08 ± 10%
ø16	M4	2.45 ± 10%
ø20, ø25	M5	5.10 ± 10%
ø32	M6	8.04 ± 10%

Allowable Rotational Torque

Bore size (mm)	ø10	ø16	ø20	ø25	ø32
Allowable rotational torque (N·m)	0.02	0.04	0.10	0.15	0.20

Moisture Control Tube IDK Series



When operating an actuator with a small diameter and a short stroke at a high frequency, the dew condensation (water droplet) may occur inside the piping depending on the conditions. Simply connecting the moisture control tube to the actuator will prevent dew condensation from occurring. For details, refer to the [Web Catalog](#).

ZCUK Series

Standard Stroke

Applicable cylinder Stroke (mm)	Double acting type/Single rod type/Non-rotating rod							
	Stroke (mm)							
Bore size (mm)	5	10	15	20	25	30	40	50
10	●	●	●	●	●	●	—	—
16	●	●	●	●	●	●	—	—
20	●	●	●	●	●	●	●	●
25	●	●	●	●	●	●	●	●
32	●	●	●	●	●	●	●	●

Theoretical Output/Double Acting Type

Unit: N

Bore size (mm)	Rod dia. (mm)	Piston area (mm ²)	Operating pressure (MPa)		
			0.3	0.5	0.7
10	4	66.0	19.8	33	46.2
16	6	172	51.6	86	121
20	8	264	79.2	132	185
25	10	412	124	206	289
32	12	691	207	346	484

Mounting

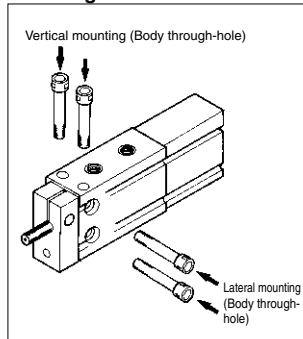

Minimum Stroke for Mounting Auto Switch

Number of auto switches	Applicable auto switch		
	D-A9□, D-A9□V	D-M9□, D-M9□V	D-M9□W, D-M9□VW
1 pc.	5	5	5
2 pcs.	10	5	10

Cylinder/Applicable Pad

• In the case of rod end male thread

Use ZPT series pad (perpendicular vacuum entry/female thread mounting).

Cylinder Model	Bore size (mm)	Pad (ZPT02 to 50□□-B4 to 10)										Thread dia.		
		Rod dia. (mm)												
		2	4	6	8	10	13	16	20	25	32	40	50	
ZCUKC	10	●	●	●	●	—	—	—	—	—	—	—	—	M4 x 0.7
ZCUKQ	16	●	●	●	●	—	—	—	—	—	—	—	—	M5 x 0.8
ZCDUKC	20	—	—	—	●	●	●	●	●	●	—	—	—	M6 x 1.0
ZCDUKQ	25	—	—	—	—	—	—	●	●	●	●	●	—	M8 x 1.25
	32	—	—	—	—	—	—	●	●	●	●	●	—	M10 x 1.25

• In the case of pad direct mounting

Use ZP series pad (single unit).

Cylinder Model	Bore size	Pad (ZP02 to 50□□)											
		Rod dia. (mm)											
		2	4	6	8	10	13	16	20	25	32	40	50
ZCUKD	10 Note 1)	●	●	●	●	—	—	—	—	—	—	—	—
ZCUKR	16	●	●	●	●	—	—	—	—	—	—	—	—
ZCDUKD	20	—	—	—	—	●	●	●	—	—	—	—	—
ZCDUKR	25	—	—	—	—	—	—	—	●	●	●	—	—
	32	—	—	—	—	—	—	—	—	—	●	●	—

Note) When using "ZC(D)UK_R10", use ZP02 to 08U□-X11. Pad shape is flat only.

Auto Switch Groove

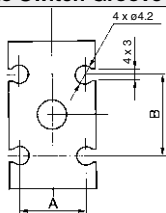

Bore size	A	B
10	10.3	13
16	15	18
20	21	23
25	27	25
32	35	27

Construction

Cap piping/Male thread: ZC(D)UKK

ø10

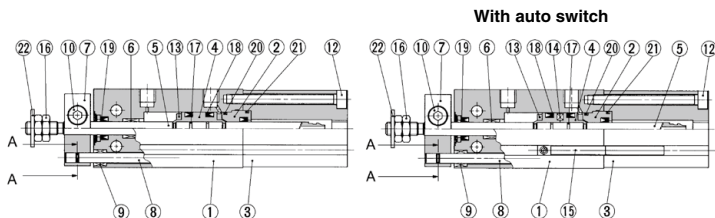
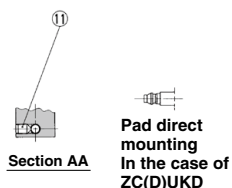

ø16 to ø32

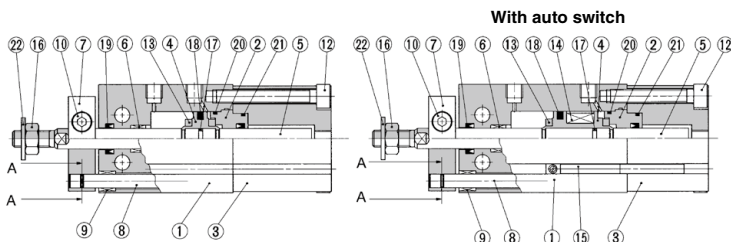
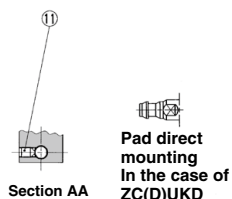

Component Parts

No.	Description	Material	Note
1	Cylinder tubing	Aluminum alloy	Hard anodized
2	Rod cover B	Aluminum alloy	Chromated
3	Cap	Aluminum alloy	Anodized
4	Piston	Aluminum alloy	Chromated
5	Piston rod	Stainless steel	
6	Bush	Bearing alloy	
7	Plate	Aluminum alloy	Nickel plated
8	Guide rod	Stainless steel	
9	Bush	Bearing alloy	
10	Hexagon socket head cap screw	Carbon steel	Chromated
11	Hexagon socket set screw	Carbon steel	Chromated
12	Hexagon socket head cap screw	Carbon steel	Nickel plated

Component Parts

No.	Description	Material	Note
13	Bumper	Urethane	
14	Magnet	—	
15	Auto switch	—	
16	Rod end nut	Carbon steel	Chromated
17	Piston gasket	NBR	
18 ^{*)}	Piston seal	NBR	
19 ^{*)}	Rod seal		
20 ^{*)}	Gasket		
21 ^{*)}	Gasket for cap		
22	Seal washer	Rolled steel/NBR	

Replacement Parts: Seal Kit

Cap piping

Kit no.	Bore size / Part no.				
	ø10	ø16	ø20	ø25	ø32
	ZCU10-PS	ZCU16-PS	ZCU20-PS	ZCU25-PS	ZCU32-PS

* Seal kit includes 18, 19, 20 and 21. Order the seal kit based on each bore size.

* Seal kit includes a grease pack (10 g).

Order with the following part number when only the grease pack is needed.

Grease pack part no.: GR-S-010 (10 g)

ZCUK Series

Construction

Rod piping-Male thread: ZC(D)UKQ

ø10

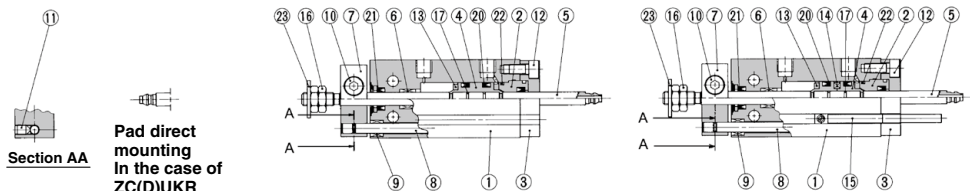

ø16 to ø32

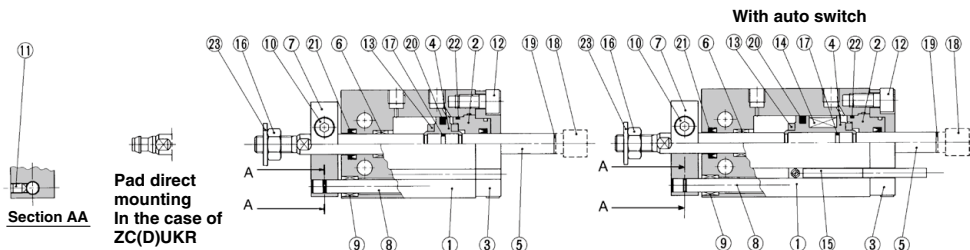

Component Parts

No.	Description	Material	Note
1	Cylinder tubing	Aluminum alloy	Hard anodized
2	Rod cover B	Aluminum alloy	Chromated
3	Rod cover retainer plate	Aluminum alloy	Anodized
4	Piston	Aluminum alloy	Chromated
5	Piston rod	Stainless steel	
6	Bush	Bearing alloy	
7	Plate	Aluminum alloy	Nickel plated
8	Guide rod	Stainless steel	
9	Bush	Bearing alloy	
10	Hexagon socket head cap screw	Carbon steel	Chromated
11	Hexagon socket set screw	Carbon steel	Chromated
12	Hexagon socket head cap screw	Carbon steel	Nickel plated

Component Parts

No.	Description	Material	Note
13	Bumper	Urethane	
14	Magnet	—	
15	Auto switch	—	
16	Rod end nut	Carbon steel	Chromated
17	Piston gasket	NBR	
18	Socket	Carbon steel	ø16 only
19	Gasket	NBR	ø16 only
20 ¹⁾	Piston seal		
21 ¹⁾	Rod seal		
22 ¹⁾	Gasket		
23	Seal washer	Rolled steel/NBR	

Replacement Parts: Seal Kit Rod piping

Kit no.	Bore size / Part no.				
	ø10	ø16	ø20	ø25	ø32
	CUW10D-PS	CUW16D-PS	CUW20D-PS	CUW25D-PS	CUW32D-PS

* Seal kit includes 20, 21 and 22. Order the seal kit based on each bore size.

* Seal kit includes a grease pack (10 g).

Order with the following part number when only the grease pack is needed.

Grease pack part no.: GR-S-010 (10 g)

Vacuum Piping: Cap Piping/Rod End Shape: Male Thread

ZC(D)UKC [Cylinder bore] – [Stroke] **D**

ø10

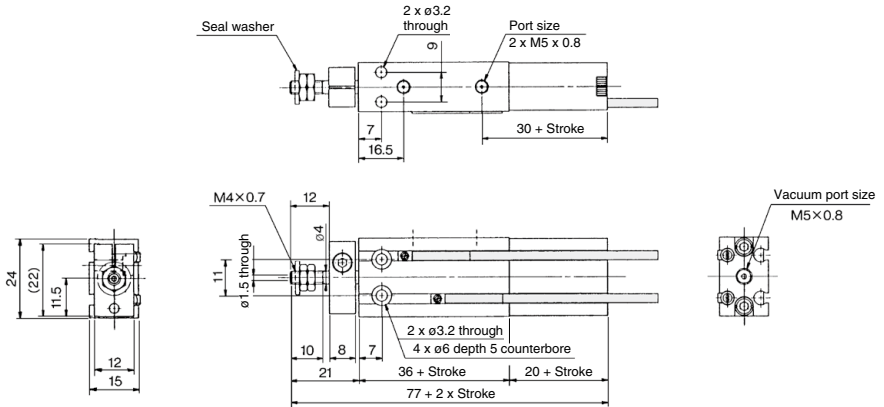

ø16 to ø32

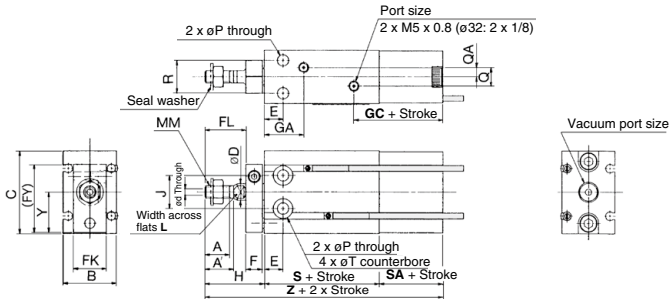

Model	Port size		Stroke range (mm)	A	A'	B	C	ød	øD	E	F	FK	FL	FY	GA	GC
	Air port	Vacuum port														
ZC(D)UKC16	M5 x 0.8	M5 x 0.8	5 to 30	11	12.5	20	32	2	6	7	8	13	17	28	16.5 (88)	31
ZC(D)UKC20	M5 x 0.8	1/8	5 to 50	12	14	26	40	3	8	9	8	16	20	33	19	33.5
ZC(D)UKC25	M5 x 0.8	1/8	5 to 50	15.5	18	32	50	4	10	10	10	20	22	43.5	21.5	34
ZC(D)UKC32	1/8	1/8	5 to 50	19.5	22	40	62	5	12	11	12	24	29	51.5	23	34.5

Model	H	J	L	MM	øP	Q	QA	R	S	SA	øT	Y	Z
ZC(D)UKC16	26	14	5	M5 x 0.8	4.5	4	2	12	30 (40)	19.5	7.6 depth 6.5	15.5	75.5 (85.5)
ZC(D)UKC20	29	16	6	M6 x 1.0	5.5	9	4.5	16	36 (46)	21	9.3 depth 8	19.5	86 (96)
ZC(D)UKC25	33	20	8	M8 x 1.25	5.5	9	4.5	20	40 (50)	21	9.3 depth 9	24.5	94 (104)
ZC(D)UKC32	42	24	10	M10 x 1.25	6.6	13.5	4.5	24	42 (52)	22	11 depth 11.5	30.5	106 (116)

(): In the case of a mounted auto switch.

Note 1) In the case of ZCUKC16-5D: 14.5 mm.

ZCUK Series

Vacuum Piping: Cap Piping/Rod End Shape: Pad Direct Mounting ZC(D)UKD [Cylinder bore] – [Stroke] D

ø10

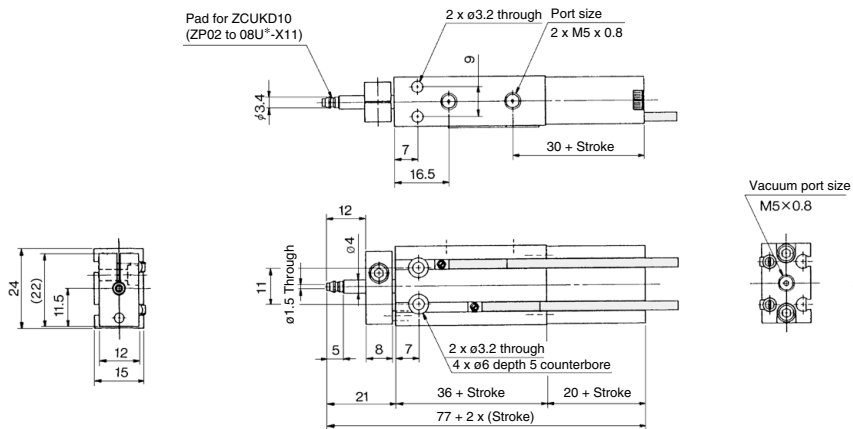

ø16 to ø32

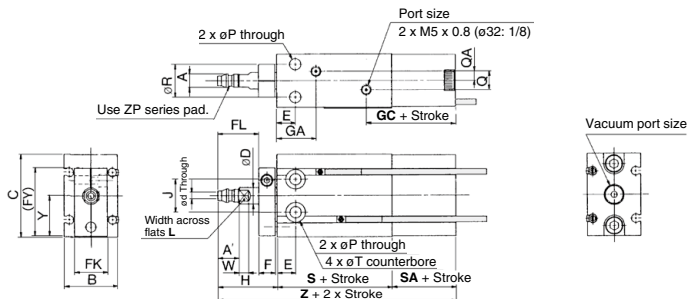

Model	Port size		Stroke range (mm)	øA	A'	B	C	ød	øD	E	F	FK	FL	FY	GA	GC
	Air port	Vacuum port														
ZC(D)UKD16	M5 x 0.8	M5 x 0.8	5 to 30	5	7	20	32	2	6	7	8	13	17	28	16.5 ⁽¹⁾	31
ZC(D)UKD20	M5 x 0.8	1/8	5 to 50	6.6	8	26	40	3	8	9	8	16	20	33	19	33.5
ZC(D)UKD25	M5 x 0.8	1/8	5 to 50	8	9	32	50	4	10	10	10	20	22	43.5	21.5	34
ZC(D)UKD32	1/8	1/8	5 to 50	11.5	10.5	40	62	5	12	11	12	24	29	51.5	23	34.5

Model	H	J	L	øP	Q	QA	R	S	SA	øT	W	Y	Z
ZC(D)UKD16	26	14	5	4.5	4	2	12	30 (40)	19.5	7.6 depth 6.5	3.5	15.5	75.5 (85.5)
ZC(D)UKD20	29	16	6	5.5	9	4.5	16	36 (46)	21	9.3 depth 8	5	19.5	86 (96)
ZC(D)UKD25	33	20	8	5.5	9	4.5	20	40 (50)	21	9.3 depth 9	5	24.5	94 (104)
ZC(D)UKD32	42	24	10	6.6	13.5	4.5	24	42 (52)	22	11 depth 11.5	5	30.5	106 (116)

(): In the case of a mounted auto switch.

Note 1) In the case of ZCUKD16-5D: 14.5 mm.

Vacuum Piping: Rod Piping/Rod End Shape: Male Thread

ZC(D)UKQ Cylinder bore — Stroke D

ø10

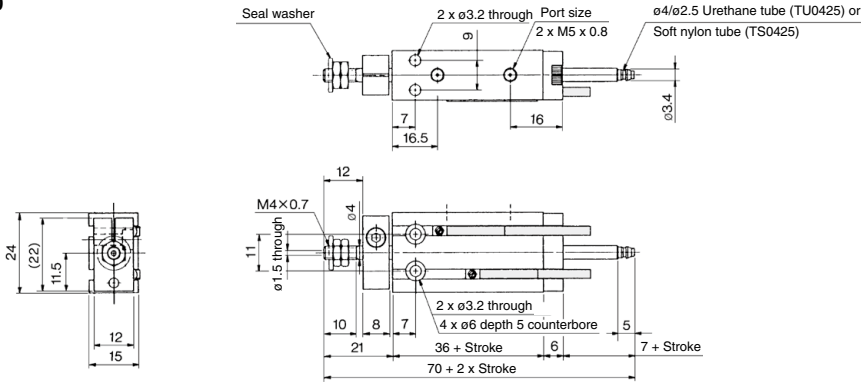

ø16 to ø32

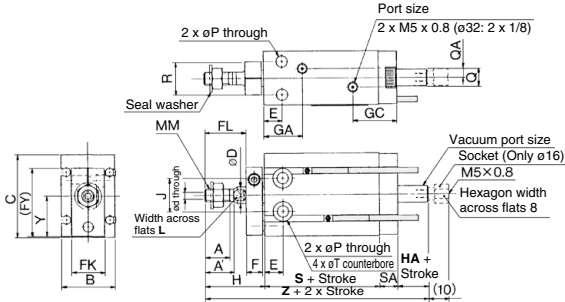

Model	Port size		Stroke range (mm)	A	A'	B	C	ød	øD	E	F	FK	FL	FY	GA	GC
	Air port	Vacuum port														
ZC(D)UKQ16	M5 x 0.8	M5 x 0.8 (Note 2)	5 to 30	11	12.5	20	32	2	6	7	8	13	17	28	16.5 (Max)	19
ZC(D)UKQ20	M5 x 0.8	M5 x 0.8	5 to 50	12	14	26	40	3	8	9	8	16	20	33	19	21.5
ZC(D)UKQ25	M5 x 0.8	M5 x 0.8	5 to 50	15.5	18	32	50	4	10	10	10	20	22	43.5	21.5	22
ZC(D)UKQ32	1/8	1/8	5 to 50	19.5	22	40	62	5	12	11	12	24	29	51.5	23	22.5

Model	H	HA	J	L	MM	øP	Q	QA	R	S	SA	øT	Y	Z
ZC(D)UKQ16	26	5	14	5	M5 x 0.8	4.5	4	2	12	30 (40)	7.5	7.6 depth 6.5	15.5	68.5 (78.5)
ZC(D)UKQ20	29	5	16	6	M6 x 1.0	5.5	9	4.5	16	36 (46)	9	9.3 depth 8	19.5	79 (89)
ZC(D)UKQ25	33	5	20	8	M8 x 1.25	5.5	9	4.5	20	40 (50)	9	9.3 depth 9	24.5	87 (97)
ZC(D)UKQ32	42	5	24	10	M10 x 1.25	6.6	13.5	4.5	24	42 (52)	10	11 depth 11.5	30.5	99 (109)

(): In the case of a mounted auto switch.

Note 1) In the case of ZCUK16-5D: 14.5 mm.

Note 2) In the case of socket equipped type.

ZCUK Series

Vacuum Piping: Rod Piping/Rod End Shape: Pad Direct Mounting ZC(D)UKR Cylinder bore — Stroke D

ø10

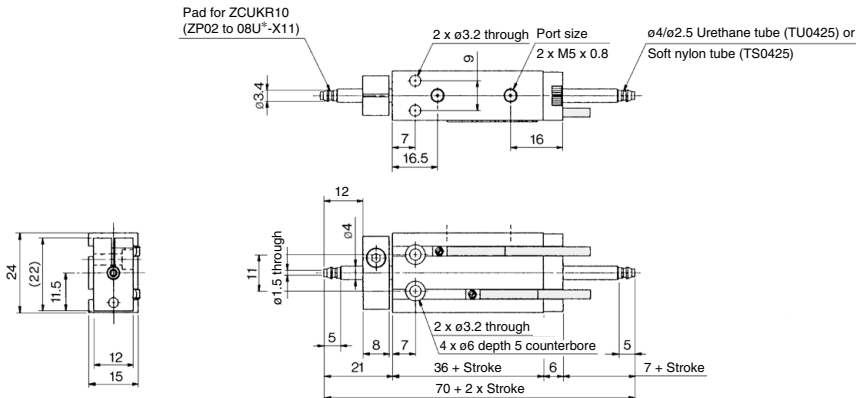

ø16 to ø32

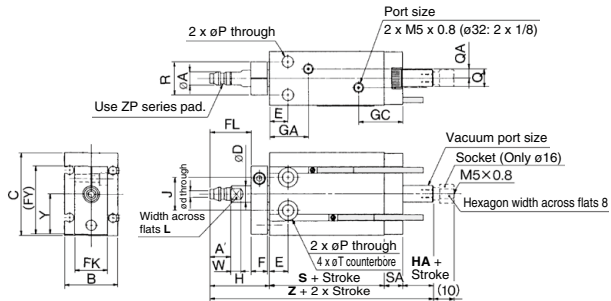

Model	Port size		Stroke range (mm)	øA	A	B	C	ød	øD	E	F	FK	FL	FY	GA	GC
	Air port	Vacuum port														
ZC(D)UKR16	M5 x 0.8	M5 x 0.8 (Note 2)	5 to 30	5	7	20	32	2	6	7	8	13	17	28	16.5 (16.5)	19
ZC(D)UKR20	M5 x 0.8	M5 x 0.8	5 to 50	6.6	8	26	40	3	8	9	8	16	20	33	19	21.5
ZC(D)UKR25	M5 x 0.8	M5 x 0.8	5 to 50	8	9	32	50	4	10	10	10	20	22	43.5	21.5	22
ZC(D)UKR32	1/8	1/8	5 to 50	11.5	10.5	40	62	5	12	11	12	24	29	51.5	23	22.5

Model	H	HA	J	L	øP	Q	QA	R	S	SA	øT	W	Y	Z
ZC(D)UKR16	26	5	14	5	4.5	4	2	12	30 (40)	7.5	7.6 depth 6.5	3.5	15.5	68.5 (78.5)
ZC(D)UKR20	29	5	16	6	5.5	9	4.5	16	36 (46)	9	9.3 depth 8	5	19.5	79 (89)
ZC(D)UKR25	33	5	20	8	5.5	9	4.5	20	40 (50)	9	9.3 depth 9	5	24.5	87 (97)
ZC(D)UKR32	42	5	24	10	6.6	13.5	4.5	24	42 (52)	10	11 depth 11.5	5	30.5	99 (109)

(): In the case of a mounted auto switch.

Note 1) In the case of ZCUK16-5D: 14.5 mm.

Note 2) In the case of socket equipped type.

Dimensions of Pad Mounted Model

Rod end shape: Male thread

Tubing bore: $\phi 10$

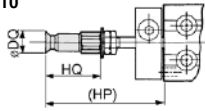

Tubing bore: $\phi 16$ to $\phi 32$

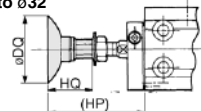

Model	Dia.(mm)	Flat/Flat with ribs										Deep				Bellows										Applicable pad model					
		2	4	6	8	10	13	16	20	25	32	40	50	10	16	25	40	6	8	10	13	16	20	25	32		40	50			
ZC(D)UKC10	ϕ DQ	2.6	4.8	7	9	—	—	—	—	—	—	—	—	—	—	—	—	7	9	—	—	—	—	—	—	—	—	—	—	ZPT□□-B4	
ZC(D)UQ10	HQ	19.5	19.5	19.5	19.5	—	—	—	—	—	—	—	—	—	—	—	—	20.5	20.5	—	—	—	—	—	—	—	—	—	—		
	HP	36.5	36.5	36.5	36.5	—	—	—	—	—	—	—	—	—	—	—	—	37.5	37.5	—	—	—	—	—	—	—	—	—	—		
ZC(D)UKC16	ϕ DQ	2.6	4.8	7	9	12	15	18	—	—	—	—	—	—	—	—	—	12	18	7	9	12	15	18	—	—	—	—	—	—	ZPT□□-B5
ZC(D)UQ16	HQ	19.5	19.5	19.5	19.5	21	21	21.5	—	—	—	—	—	—	—	—	—	24	25	20.5	20.5	25	27.5	29	—	—	—	—	—	—	
	HP	41.5	41.5	41.5	41.5	44	42	42.5	—	—	—	—	—	—	—	—	—	45	46	42.5	42.5	46	48.5	50	—	—	—	—	—	—	
ZC(D)UKC20	ϕ DQ	—	—	—	—	12	15	18	23	28	35	—	—	—	—	—	—	12	18	28	—	—	—	—	—	—	—	—	—	—	ZPT□□-B6
ZC(D)UQ20	HQ	—	—	—	—	21	21	21.5	23	23	23.5	—	—	—	—	—	—	24	25	29	—	—	—	—	—	—	—	—	—	—	
	HP	—	—	—	—	44	44	44.5	46	46	46.5	—	—	—	—	—	—	47	48	52	—	—	—	—	—	—	—	—	—	—	
ZC(D)UKC25	ϕ DQ	—	—	—	—	—	—	—	—	—	—	—	—	—	—	—	—	23	28	35	43	53	—	—	—	—	—	—	—	—	ZPT□□-B8
ZC(D)UQ25	HQ	—	—	—	—	—	—	—	—	—	—	—	—	—	—	—	—	29	29	20.5	32	33	—	—	—	—	—	—	—	—	
	HP	—	—	—	—	—	—	—	—	—	—	—	—	—	—	—	—	54	54	54.5	57	58	—	—	—	—	—	—	—	—	
ZC(D)UKC32	ϕ DQ	—	—	—	—	—	—	—	—	—	—	—	—	—	—	—	—	23	28	35	43	53	—	—	—	—	—	—	—	—	ZPT□□-B10
ZC(D)UQ32	HQ	—	—	—	—	—	—	—	—	—	—	—	—	—	—	—	—	32	32	32.5	35	36	—	—	—	—	—	—	—	—	
	HP	—	—	—	—	—	—	—	—	—	—	—	—	—	—	—	—	64	64	64.5	67	68	—	—	—	—	—	—	—	—	
	HP	—	—	—	—	—	—	—	—	—	—	—	—	—	—	—	—	70	77.5	—	—	—	—	—	—	—	—	—	—		

Rod end shape: Pad direct mounting

Tubing bore: $\phi 10$

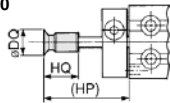

Tubing bore: $\phi 16$ to $\phi 32$

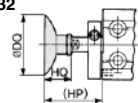

Model	Dia.(mm)	Flat/Flat with ribs										Deep				Bellows										Applicable pad model				
		2	4	6	8	10	13	16	20	25	32	40	50	10	16	25	40	6	8	10	13	16	20	25	32		40	50		
ZC(D)UKD10	ϕ DQ	2.6	4.8	7	9	—	—	—	—	—	—	—	—	—	—	—	—	—	—	—	—	—	—	—	—	—	—	—	—	ZP□□-X11
ZC(D)UKR10	HQ	10	10	10	10	—	—	—	—	—	—	—	—	—	—	—	—	—	—	—	—	—	—	—	—	—	—	—	—	
	HP	26	26	26	26	—	—	—	—	—	—	—	—	—	—	—	—	—	—	—	—	—	—	—	—	—	—	—	—	
ZC(D)UKD16	ϕ DQ	2.6	4.8	7	9	—	—	—	—	—	—	—	—	—	—	—	—	—	—	7	9	—	—	—	—	—	—	—	—	ZP□□□
ZC(D)UKR16	HQ	12	12	12	12	—	—	—	—	—	—	—	—	—	—	—	—	—	—	13	13	—	—	—	—	—	—	—	—	
	HP	31	31	31	31	—	—	—	—	—	—	—	—	—	—	—	—	—	—	32	32	—	—	—	—	—	—	—	—	
ZC(D)UKD20	ϕ DQ	—	—	—	—	12	15	18	—	—	—	—	—	—	—	—	—	12	18	—	—	—	—	—	—	—	—	—	—	ZP□□□
ZC(D)UKR20	HQ	—	—	—	—	12	12	12.5	—	—	—	—	—	—	—	—	—	15	16	—	—	—	—	—	—	—	—	—	—	
	HP	—	—	—	—	33	33	33.5	—	—	—	—	—	—	—	—	—	36	37	—	—	—	—	—	—	—	—	—	—	
ZC(D)UKD25	ϕ DQ	—	—	—	—	—	—	—	—	—	—	—	—	—	—	—	—	—	—	28	—	—	—	—	—	—	—	—	—	ZP□□□
ZC(D)UKR25	HQ	—	—	—	—	—	—	—	—	—	—	—	—	—	—	—	—	—	—	20	—	—	—	—	—	—	—	—	—	
	HP	—	—	—	—	—	—	—	—	—	—	—	—	—	—	—	—	—	—	44	—	—	—	—	—	—	—	—	—	
ZC(D)UKD32	ϕ DQ	—	—	—	—	—	—	—	—	—	—	—	—	—	—	—	—	—	—	43	—	—	—	—	—	—	—	—	—	ZP□□□
ZC(D)UKR32	HQ	—	—	—	—	—	—	—	—	—	—	—	—	—	—	—	—	—	—	29	—	—	—	—	—	—	—	—	—	
	HP	—	—	—	—	—	—	—	—	—	—	—	—	—	—	—	—	—	—	60.5	—	—	—	—	—	—	—	—	—	

Note) ZP□□-X11: Flat type only.

Accessory Dimensions (Attached only to a rod end male thread type.)

Rod end nut

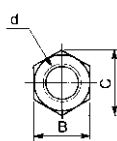
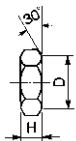

Material: Carbon steel

Part no.	Applicable cylinder bore (mm)	d	H	B	C	D
NTP-010	10	M4 x 0.7	2.4	7	8.1	6.8
NTJ-015C	16	M5 x 0.8	4	8	9.2	7.8
NT-015A	20	M6 x 1.0	5	10	11.5	9.8
NT-02	25	M8 x 1.25	5	13	15.0	12.5
NT-03	32	M10 x 1.25	6	17	19.6	16.5

Seal washer

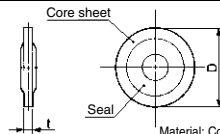

Material: Core sheet — Rolled steel
Seal — NBR

Part no.	Applicable cylinder bore (mm)	t	D
WCS4 x 0.7	10	1.2	11.5
WCS5 x 0.8	16	1.2	12.5
WCS6 x 1	20	1.2	14.0
WCS8 x 1	25	1.6	15.5
WCS10 x 1	32	1.6	18.0

ZCUK Series Auto Switch Mounting

Proper Auto Switch Mounting Position (Detection at stroke end) and Mounting Height

D-M9□
D-M9□W
D-M9□A
D-A9□

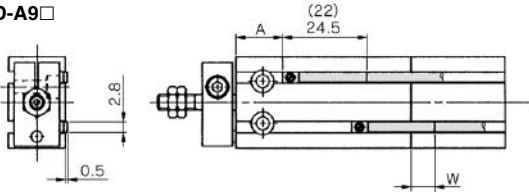

() : Denotes the values of D-A96.

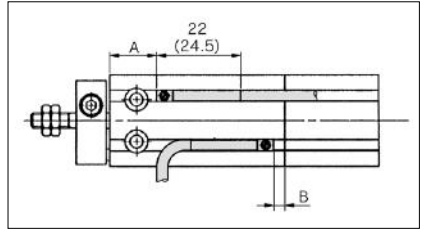

D-M9□V
D-M9□WV
D-M9□AV
D-A9□V

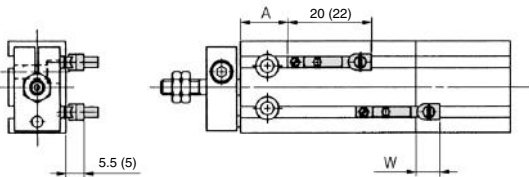

() : Denotes the values of D-A9□V.

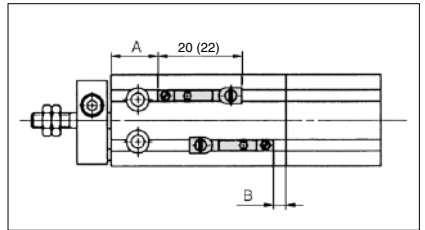

Bore size (mm)	D-A9□, D-A9□V		D-M9□, D-M9□W			D-M9□V, D-M9□WV			D-M9□A			D-M9□AV			
	A	B	W	A	B	W	A	B	W	A	B	W	A	B	W
10	12.5	3	-1.5 (1)	16.5	7.5	2.5	16.5	7.5	0.5	16.5	7.5	4.5	16.5	7.5	2.5
16	16	4	-2 (0.5)	20	8	1.5	20	8	0	20	8	3.5	20	8	2
20	20	6	-4 (-1.5)	24	10	0	24	10	-2	24	10	2	24	10	0
25	22.5	7	-5.5 (-3)	26.5	11.5	-1.5	26.5	11.5	-3.5	26.5	11.5	0.5	26.5	11.5	-1.5
32	23.5	8	-6.5 (-4)	27.5	12.5	-2.5	27.5	12.5	-4.5	27.5	12.5	-0.5	27.5	12.5	-2.5

Note 1) Figures in the table above are used as a reference when mounting the auto switches for stroke end detection. In the case of actually setting the auto switches, adjust them after confirming their operation.

Note 2) Negative figures in the table show dimensions mounted inside cylinder body.

Note 3) In the case of 5 mm stroke or the 10 mm stroke, there are times in which the auto switches will not turn OFF or 2 auto switches will turn ON simultaneously due to their movement range. Therefore, set the position approximately 1 to 4 mm outward from the values given in the table above. Then, perform an operation inspection to make sure that the auto switches operate normally (if 1 switch is used, make sure that it turns ON and OFF properly; if 2 auto switches are used, make sure that both switches turn ON).

Note 4) Figures in () in the table W are D-A90 and A93.

Operation Range

Auto switch model	Bore size (mm)				
	10	16	20	25	32
D-A9□, A9□V	6	9	11	12.5	14
D-M9□, M9□V D-M9□W, M9□WV D-M9□A, M9□AV	4	5	7	7	7

* Since this is the average value at a normal temperature including hysteresis (tolerance $\pm 30\%$), it is not guaranteed.

Figures may change substantially depending upon the surrounding environment.

Mounting of Auto Switch

Cautions on Proximity Installation

When free mounting cylinders equipped with auto switches are used, the auto switches could activate unintentionally if the installed distance is less than the dimensions shown in the table. Therefore, make sure to provide a greater clearance. Due to unavoidable circumstances, if they must be used with less distance than the dimensions given in the table, the cylinders must be shielded. Therefore, affix a steel plate or a magnetic shielding plate (MU-S025) to the area on the cylinder that corresponds to the adjacent auto switch. (Please contact SMC for details.) Auto switches may malfunction if a shielding plate is not used.

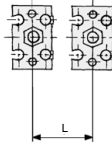

Bore size (mm)	Mounting pitch L (mm)
10	20
16	33
20	40
25	46
32	56

Shielding plate (MU-S025) dimensions

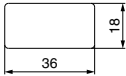

Material: Ferrite stainless steel, Thickness: 0.3 mm
The product is attached to the cylinder since the bottom side is pre-treated with adhesive glue.

Weight

Basic Type/With Auto Switch (): Denotes the values with D-A93.

Unit: g

Model	Bore size (mm)	Cylinder stroke (mm)							
		5	10	15	20	25	30	40	50
ZC(D)UKC	10	63 (68)	69 (79)	75 (85)	81 (91)	87 (97)	93 (103)	—	—
	16	103 (128)	115 (145)	127 (157)	139 (169)	151 (181)	163 (193)	—	—
	20	180 (214)	204 (244)	228 (267)	252 (292)	276 (316)	300 (340)	348 (388)	396 (436)
	25	304 (358)	343 (402)	382 (441)	421 (480)	460 (519)	499 (558)	577 (636)	655 (714)
	32	514 (587)	574 (652)	634 (712)	694 (772)	754 (832)	814 (892)	934 (1012)	1054 (1132)
ZC(D)UKQ	10	49 (54)	53 (63)	57 (67)	61 (71)	65 (75)	69 (79)	—	—
	16	79 (104)	86 (116)	93 (123)	100 (130)	107 (137)	114 (144)	—	—
	20	145 (179)	159 (198)	173 (212)	187 (226)	201 (240)	215 (254)	243 (282)	271 (310)
	25	259 (313)	279 (338)	299 (358)	319 (378)	339 (398)	359 (418)	399 (458)	439 (498)
	32	421 (494)	451 (529)	481 (559)	511 (589)	541 (619)	571 (649)	631 (709)	691 (769)

Besides the models listed in How to Order, the following auto switches are applicable.

- * For solid state switches, auto switches with a pre-wired connector are also available. Refer to pages 1340 and 1341 for details.
- * Normally closed (NC = b contact) solid state switches (D-M9□E(V)) are also available. Refer to page 1290 for details.