

Time, staircase lighting,
twilight switches and thermostats
Solutions for comfort, energy saving
and simple automations.

Table of Contents

Introduction.....	3
AT electro-mechanical time switches	4
D Line digital time switches.....	10
DTS annual digital time switches	22
E 232 staircase lighting switch with warning function.....	30
TW twilight switches	36
TWP twilight switches.....	44
THS modular thermostats	46
Guide to installation in residential buildings	52
Guide to installation in commercial buildings	56
Guide to installation in industrial buildings.....	60
Guide to installation in the agrifood sector	64
Order codes	66
Wiring diagrams	68
Overall dimensions.....	70
Frequent queries and problem-solving	72
Glossary.....	73

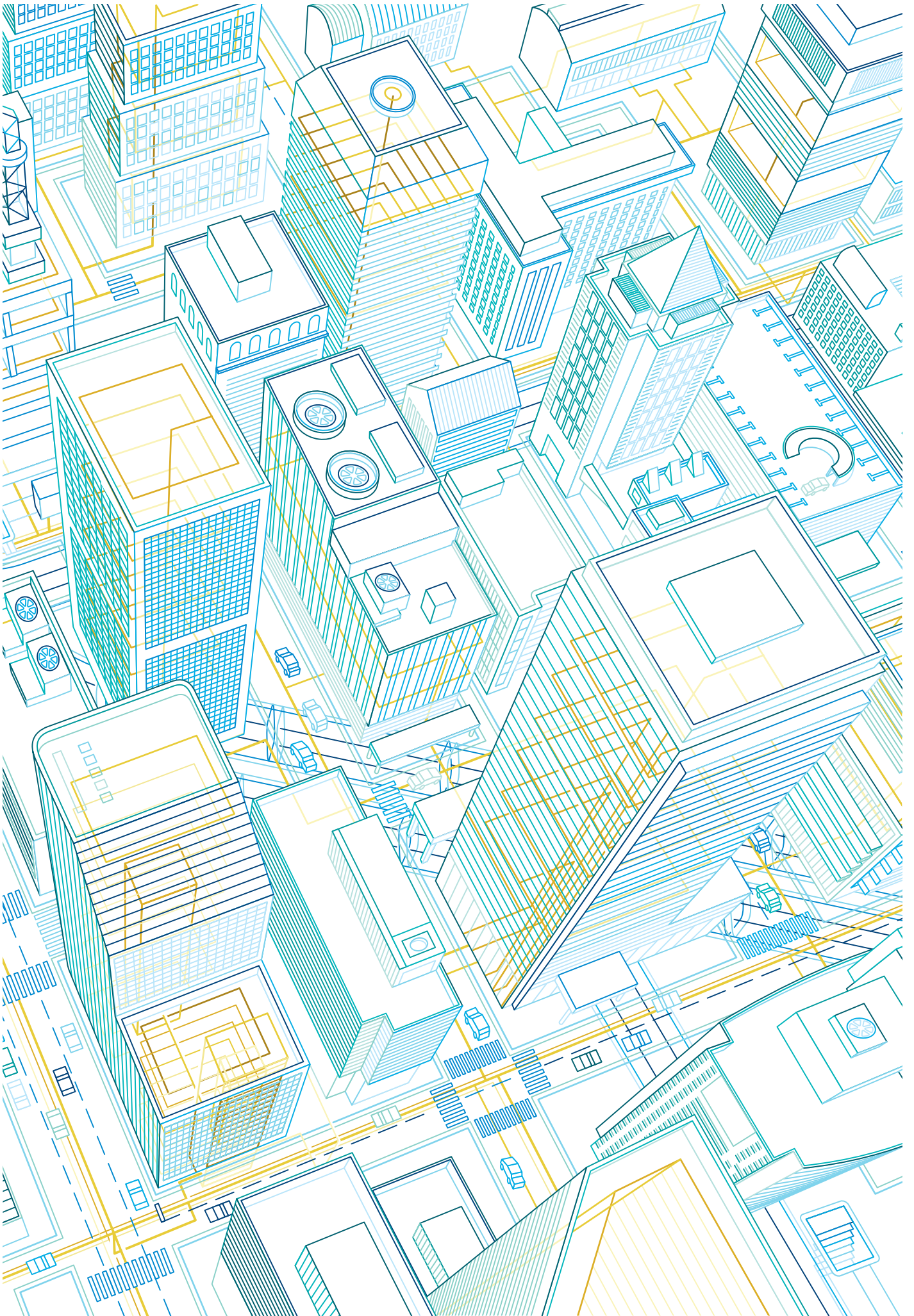

ABB's solutions for temperature regulation and lighting control to suit specific requirements.

To control the activation of electrical loads in an installation, and consequently, improve their use and ensuring energy-efficient management, ABB offers a wide range of switches to control the electric utilities as needed to suit the requirements of a vast variety of applications.

Continual investments in research and development have made ABB a reference point as manufacturer of ground-breaking products that fully reflect the installation requirements of even the most demanding customers.

ABB's target is to supply the market with products that are pioneering as to design, energy efficiency, safety, functionality and environmental impact. High performance, the utmost reliability over time, silent operation and a compact design are amongst the principal characteristics featured by the AT analog, D Line and DTS digital time switches, the TW twilight switches, E232 staircase lighting switches and THS modular thermostats. ABB's System pro *M* compact® load management devices are thus the ideal solution for every requirement in the residential, services-providing and industrial sectors.

AT electro-mechanical time switches

AT electro-mechanical time switches are especially needed in systems where the controlgear is switched ON and OFF with long intervals between, e.g. 15-30 minutes for the daily versions and 2 hours for the weekly ones.

These electro-mechanical time switches are available in daily and weekly version with 16 A contact, 1 NO for the 1 module version and 1 NO/NC for the 2 and 3 modules version. They can be operated according to a program or they can be set to a permanent ON function (ON-OFF for the 3-module version). The -R type are equipped with an internal battery, which is normally which enables them to maintain their timing function even in case of lengthy power supply failures. These switches are suitable for installation in the lighting systems of shops, public buildings, schools, heating and irrigation systems and so forth.



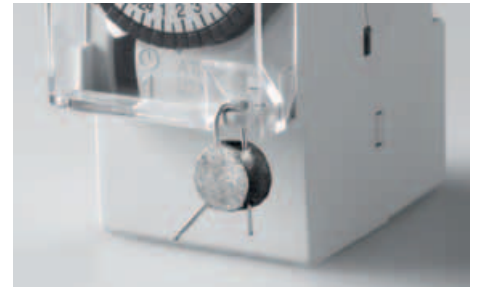

Main features

- The dial is clearly visible from the front
- Accurate and readable indication of the time
- The dial is completely accessible without tools
- Sealable and loss-proof cover to prevent unauthorised access
- RoHS compliant

Other features of the range

- 200 hours running reserve for AT1-R, AT3-R and AT3-7R and 150 hours for AT2-R and AT2-7R
- 1, 2 and 3 module versions
- Daily and weekly versions with and without reserve
- Loss-proof screw terminals
- Simple and compact design
- Minimum switching time:
 - 15' for AT1, AT1-R, AT3 and AT3-R (daily versions)
 - 30' for AT2 and AT2-R (daily versions)
 - 210' for AT2-7R (weekly version)
 - 120' for AT3-7R (weekly version)

How many modules do you need?

- 1 module is the right choice when you need to save space on the DIN rail, but the switching dial is not fully readable
- 3 modules are ideal for a fully readable of the dial and thus of the programming
- 2 modules is the right compromise

When you must to use the running reserve?

Always! The running reserve keeps the time switch synchronized even in a blackout. Time switch without running reserve has no battery. This means it is more economical, but it needs to be regulated again after a power failure. It is only suitable when the installation has an UPS.

AT electro-mechanical time switches

Technical specifications

		AT1	AT1-R	AT2	AT2-R	AT2-7R	AT3	AT3-R	AT3-7R
Rated voltage	V	230 AC ± 10%							
Contact type		1 NO			1 NO/NC				
Contact capacity: resistive load	A	16							
Inductive load	A	4						3	
Rated frequency	Hz	50-60							
Time base		quartz							
Minimum switching times	min	15	15	30	30	210	15	15	120
Max number of commands per cycle		96	96		48		96	96	84
Running reserve	h	-	200	-	150	150	-	200	200
Accuracy		± 1sec/24h							
Power consumption	VA	0.5							
Max switching power	W	4000			3500			4000	
Max. terminal size for cable	mm ²	4			2.5			4	
Terminals		with captive screws							
Mounting		on DIN rail							
Operating temperature	°C	-10...+55							
Storage temperature	°C	-10...+55			-10...+50			-20...+70	
Modules		1			2			3	
Reference Standards		EN 60730-1 ; EN 60730-2-7							

How to program AT1 - AT1-R

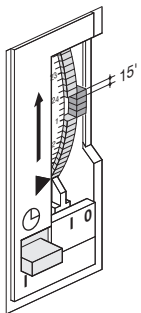

Switching dial

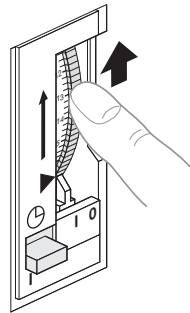

Time setting

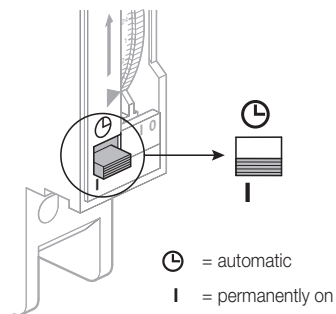

Manual override

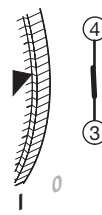
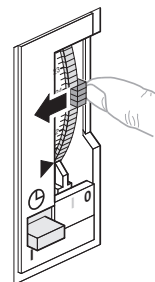
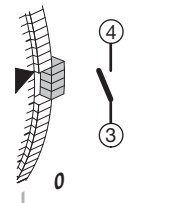
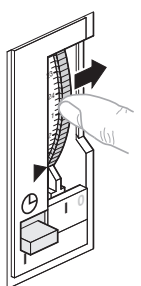

Programming

How to program AT2 - AT2-R - AT2-7R

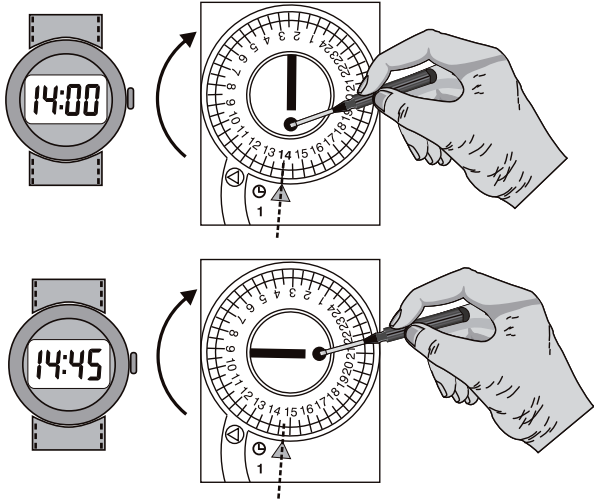

Time setting

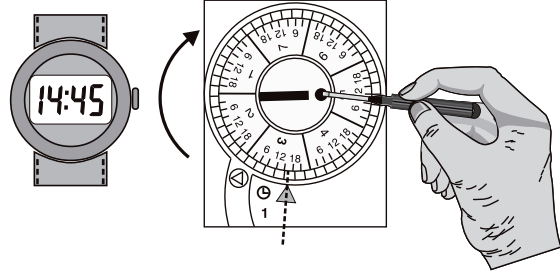

Example: 3 = Wednesday 14:45

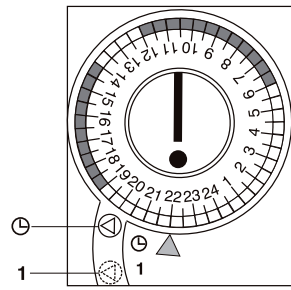

⌚ = Automatic programmed operation
1 = Permanently ON

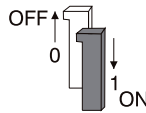

06:00 ... 12:00 ON
12:00 ... 14:00 OFF
14:00 ... 19:00 ON
19:00 ... 06:00 OFF

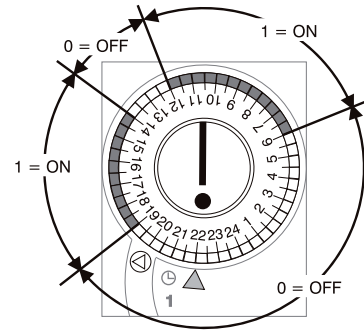

Programming

How to program AT3 - AT3-R - AT3-7R

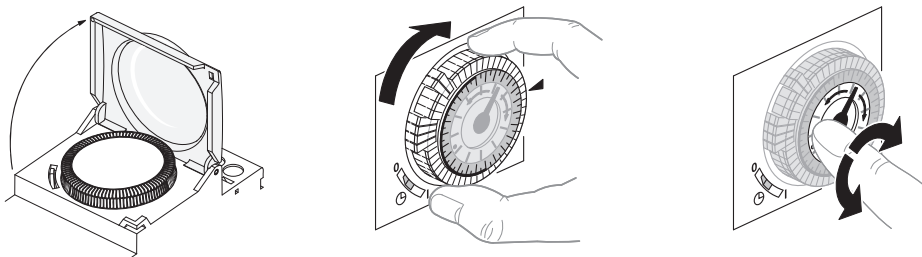

Time setting

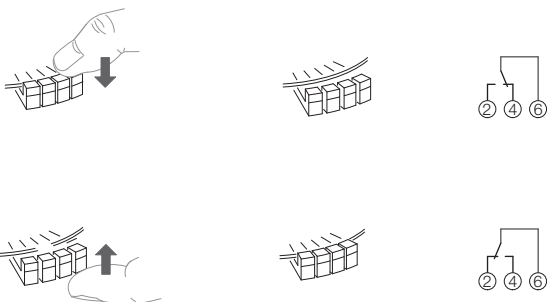

Programming

3-position selector switch

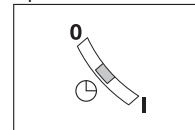

0 = Permanently off
⌚ = Automatic programmed operation
1 = Permanently on

Manual mode

AT electro-mechanical time switches

Operating principle

The AT electro-mechanical time switches enable to control the circuit opening/closing according to a daily or weekly program or to manually set permanent ON/OFF operation.

Application environments

The AT electro-mechanical time switches are particularly indicated in any environment and situation where it is necessary to program system load operation according to a daily or weekly frequency (shop lighting system, public buildings, heating systems, irrigation systems, etc.).

Installation example

As shown in the diagrams, one of the possible applications is to mount the AT3-7R electromechanical time switch inside the power supply circuit of a golf field. In this case the device programming enables the daily activation of the irrigation system at a preset time

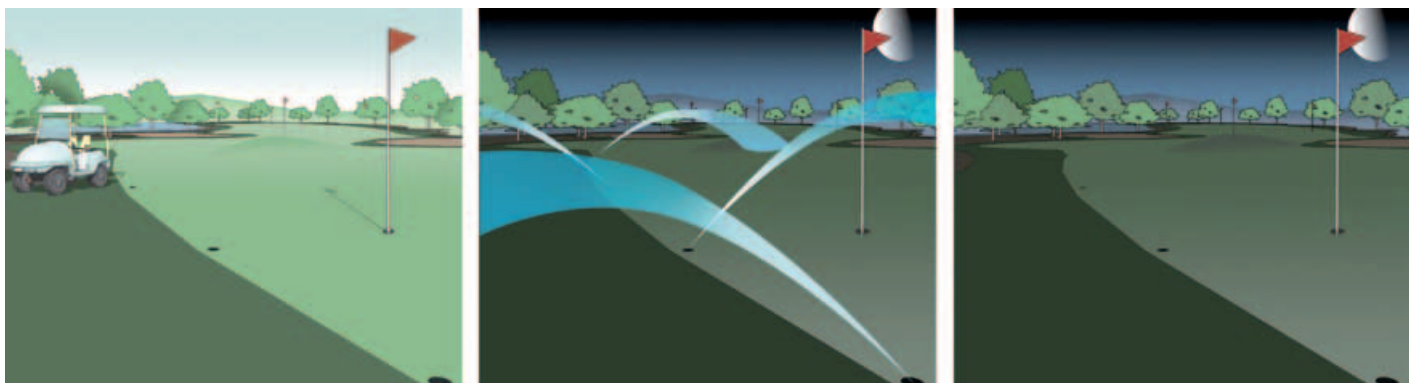
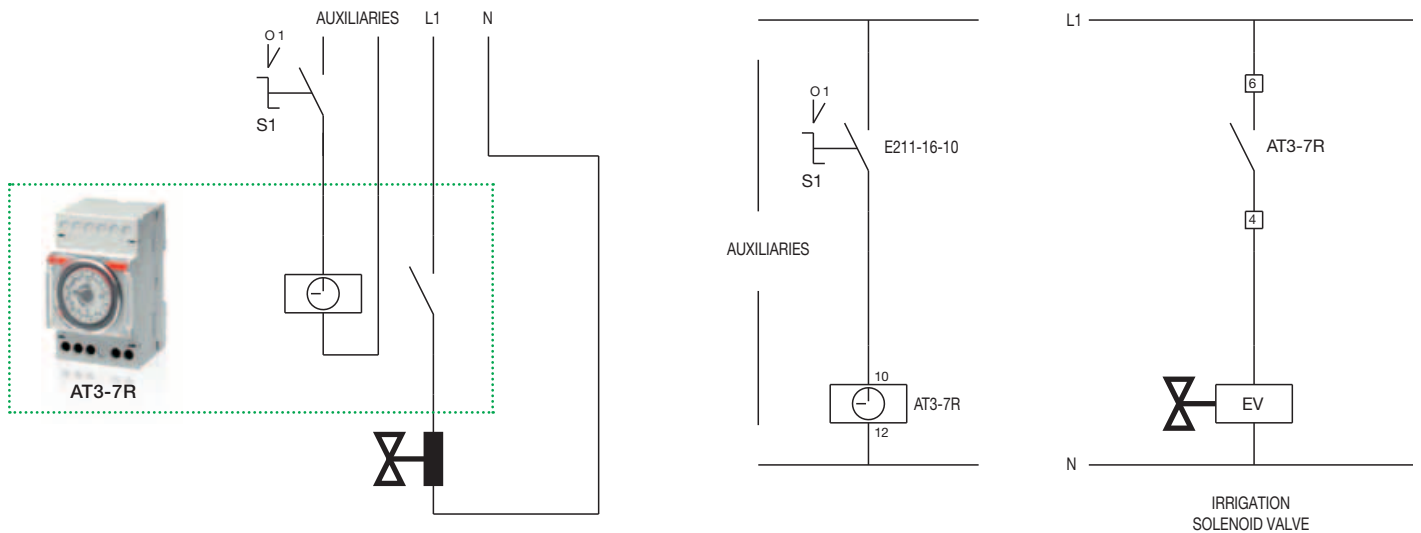



D Line digital time switches

D Line is ABB's new range of digital time switches. An exclusive design, featuring a backlit white LCD display, plus extremely easy use with two lines of text menu and just four pushbuttons, make the D Line products ideal for automating the functions of the installation.



Thanks to the pioneering way in which vacation periods can be managed, the new D Line allows you to override the normal weekly program for one or more periods of the year or even through different years. The range includes versions with 1 and 2 channels, equipped with large capacity internal batteries so they are able to function during a blackout and an EEPROM permanent data store, to ensure that the scheduled program is followed and the date and hour settings are maintained even during a power failure.

The "PLUS" versions can copy one or more programs and transfer them to different devices by means of a flash drive, without wasting time and avoiding re-programming errors. The "SYNCHRO" versions can be combined with the D DCF antenna, allowing the circuit-breaker to be automatically synchronized with the DCF77 Frankfurt timing signal, or with the D GPS antenna, which synchronizes with the signal received by the Global Positioning System and provides a more precise solution than the terrestrial transmissions. These versions are required when one or more circuit-breakers need to be kept synchronized, even when installed in unattended areas.

Why are the new D Line time switches supplied without a preset date and time?

Unlike the models already preset in the factory, the D Line battery does not discharge as it maintains the settings during a long storage period. This allows the customer to benefit from full battery life, as the battery begin to operate when the keypad is pressed for the first time.

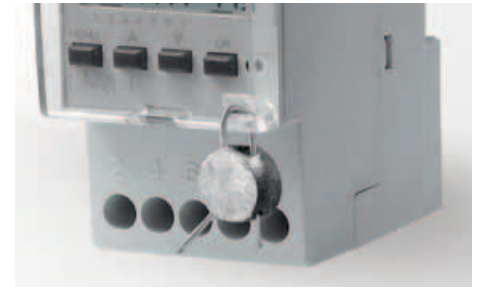

Operating principle

- Management of vacation periods, which can be programmed at different times of the year
- Multilanguage menu, with a choice of 11 different languages
- Zero cross switching, for a longer lasting relay and the actual load itself
- LCD display with high-level contrast, providing optimum visibility in all conditions thanks to timed backlighting
- 1 second minimum switching time
- Product warranty management: the internal clock and battery activate when the time switch is first installed
- Monitored maintenance for the connected equipment: the count-down function transmits an alert to the display after a preset number of operating hours

Range specifications

- Vast choice of programs: standard, cyclic, random and vacation
- Permanent or temporary override function, activated with a single touch
- Programming via menus with 4 simple keys
- The status of each contact is clearly displayed
- Full graphic display of the switching sequence established by the program for each of the channels of the day in question
- Generously sized 34 mm LCD display
- External inputs for connecting one or more remote controls, e.g.: circuit-breakers or pushbuttons
- 64 memory locations
- Accuracy of ± 0.5 seconds/day
- Automatic summer/winter time switch-over
- 6 years running reserve (lithium battery)
- Sealable and loss-proof cover to prevent unauthorised access

Accessories available

- DCF77 antenna
- GPS antenna
- Flash key
- Programming software and USB interface

What does zero cross switching mean?

The device is able to monitor the network sinusoid and to switch the load at the exact instant in which the voltage is annulled. This allows extremely high maximum loads to be obtained while ensuring that both the relay and the load itself are longer lasting.

D Line digital time switches

The special functions of the new range

Standard program

The standard function allows one or more series of opening and closing operations to be performed so as to control loads such as the lighting and heating systems in a school.

The ON time and the OFF time can differ in an independent way in both channels (lighting ON from MON to FRI from 08:00 hrs to 18:00 hrs and heating ON from MON to FRI from 07:00 hrs to 10:00 hrs).

Lighting system in a school

In the example, the school's lighting system is ON from 08:00 hrs until 18:00 hrs.

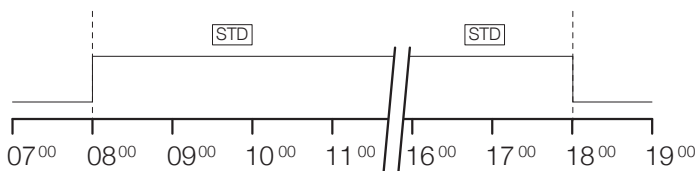

Heating system in a school

In the example, the school's heating system is ON from 07:00 hrs until 10:00 hrs.

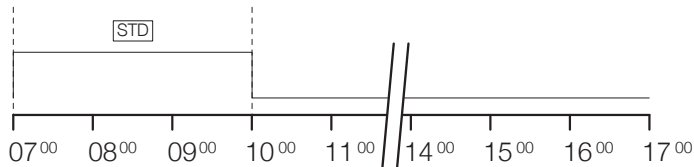

Cyclic program

The cyclic function allows a series of impulses or a timing cycle to be performed so as to control loads such as an illuminated sign or the school bells. The ON time and the OFF time can vary from 1 second to 23 hours, 59 minutes and 59 seconds.

Illuminated sign

In the example, the illuminated sign comes ON at 19:00 hrs and generates a series of impulses lasting for 10 seconds ON and OFF, until 02:00 hrs in the morning.

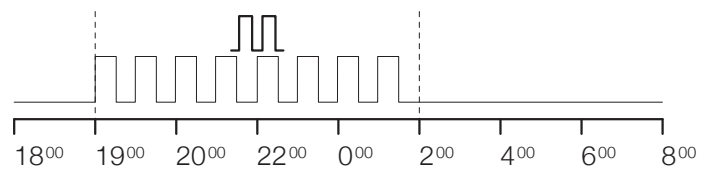

School bell

In the example, the school bell rings for 3 seconds every 50 minutes, from 08:00 hrs until 13:00 hrs.

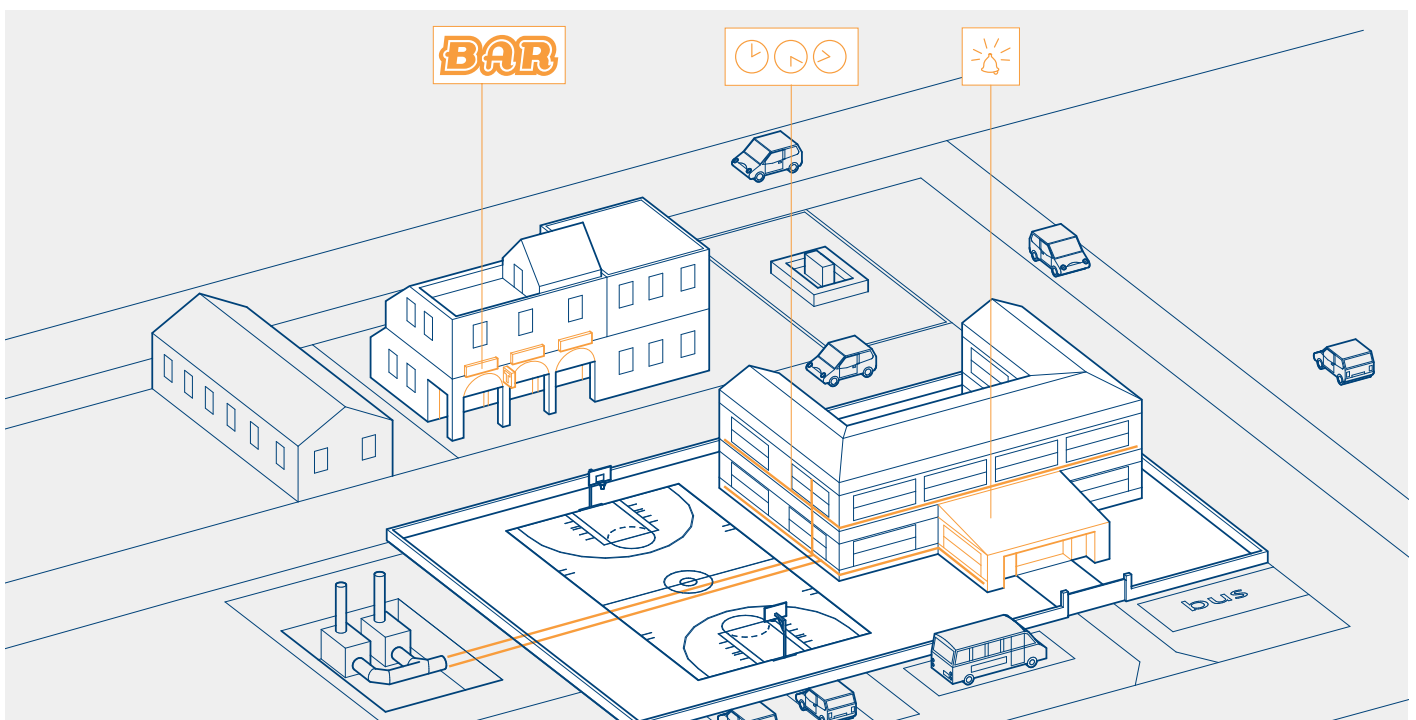
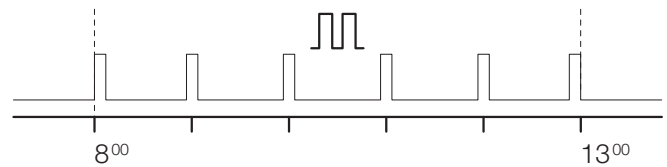

Vacation program

The vacation program allows the normal programs to be halted for an established period. This is very useful during the vacation period. The vacation program can also manage periods spanning different years, such as the period from Christmas to Epiphany.

Heating system in an office

The example shows that the office heating system was turned OFF from 16:00 hrs on 24 December 2009 for the Christmas holiday period and ON again at 08:00 hrs on 6 January 2010 when the office opened again.

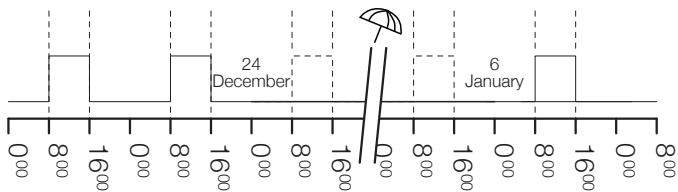

Random program

The random program allows you to turn the utility ON and OFF in the random mode, so as to simulate the presence of persons in unmanned places, for example.

Villa

The example shows how the random program simulates the presence of persons in a villa during the evening hours.

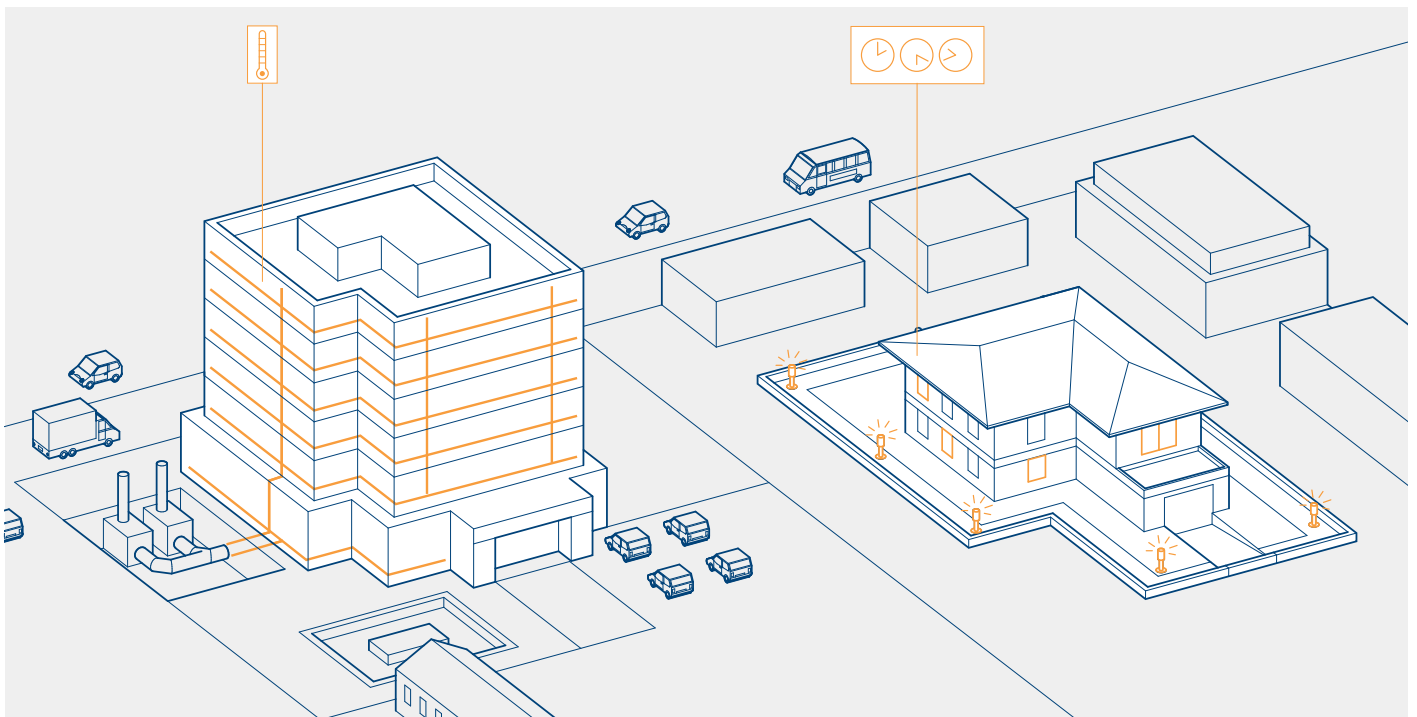
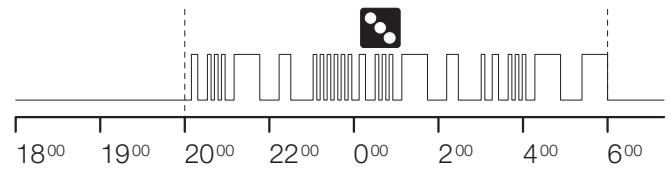

D Line digital time switches

Accessories for PLUS and SYNCHRO

D KEY

D KEY flash key for executing programs recorded in the key, transferring programs from the time switch to the key and vice versa, and for reading the programs in the key.

D SW software

You can program the D Line digital time switches from your PC thanks to D SW software, which allows you to work through the programming steps in a quick and simple way while comfortably seated at your desk.

This is because the program can be transferred to the flash key and then copied into several devices without the risk of re-programming errors.

Once created, the program can be saved in a file in the PDF format, ready to be printed and stored inside the switchboard.

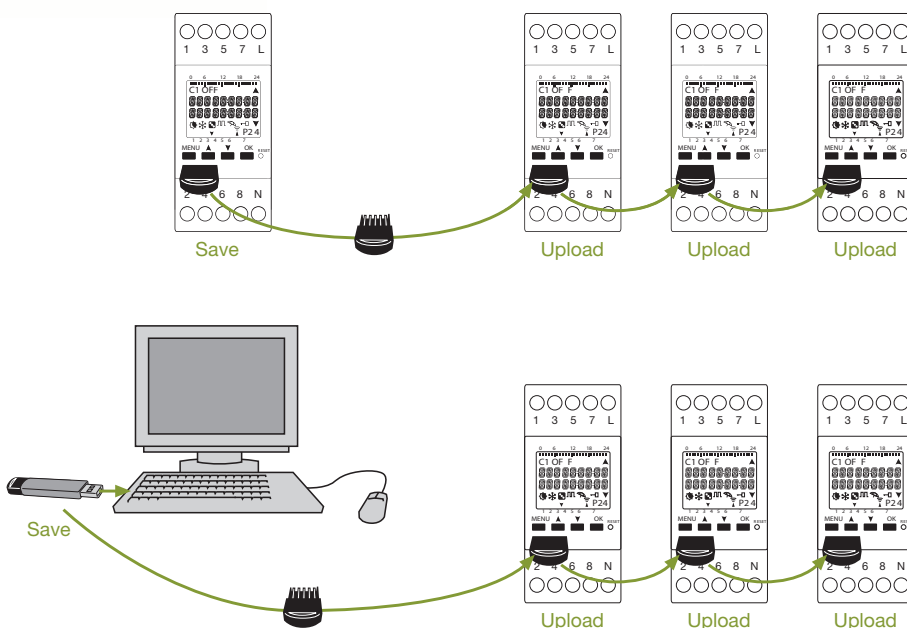

The flash key allows you to execute a program in the EMD external memory in the automatic mode, save the programs in the time switch or ones that have been created with the D SW programming software in the D KEY flash drive and then work through the procedures in reverse. The vacation programs can also be uploaded and downloaded to and from the D KEY.

D DCF77 antenna

This antenna receives the hourly texts transmitted by the DCF77 emitter situated in Mainflingen, Germany, in the Frankfurt region. The programmers are automatically positioned on the time, date and on the exact summer or winter timeframe. The antenna allows up to 10 programmers in series to be maintained in the synchronized state. The power of the emitter of Frankfurt am Main is 50 kW and its range is about 2,500 km. The signal is sometimes received in a discontinuous way and not all places could be covered owing to dead zones created by the territory, especially in countries that are fairly far from the emitter. Italy is fully covered. The reception is optimal when the marked antenna face is pointed towards Frankfurt.

D GPS antenna

The D GPS antenna provides an accurate localization and time information in all weather conditions, both day and night in any part of the world, since the time is obtained from several sources at the same time, thus allowing the clock to compensate for delays. The synchronization received from the Global Positioning system provides a more accurate value than the terrestrial transmissions. The GPS system combines the time supplied by various atomic clocks installed on board the satellites of the system with the time given by a network of terrestrial stations and corrects the errors.

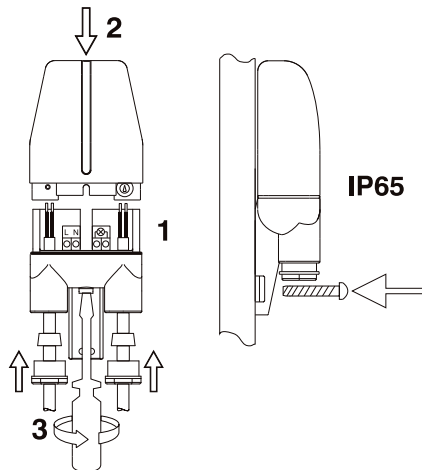
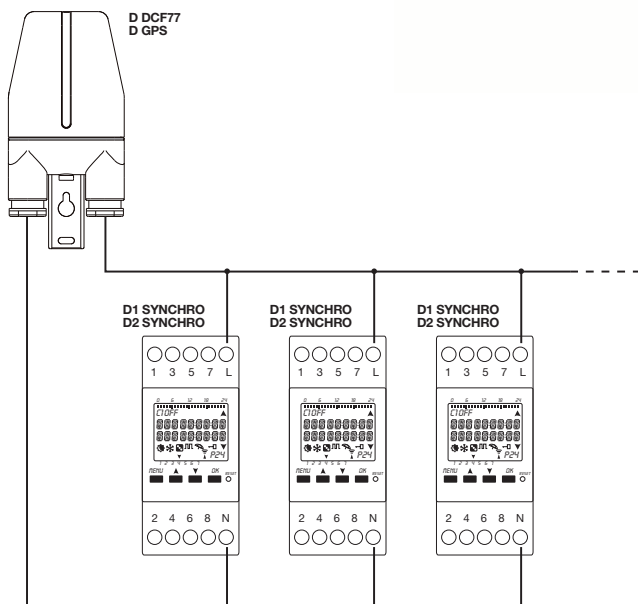

Up to 10 programmers can be piloted with the D DCF77 and D GPS antennas. The polarity is of no importance for the first programmer connected, unlike the following ones, which must comply with the polarity dictated by the first.

D Line digital time switches

Programming menus

Programming menu without programming key

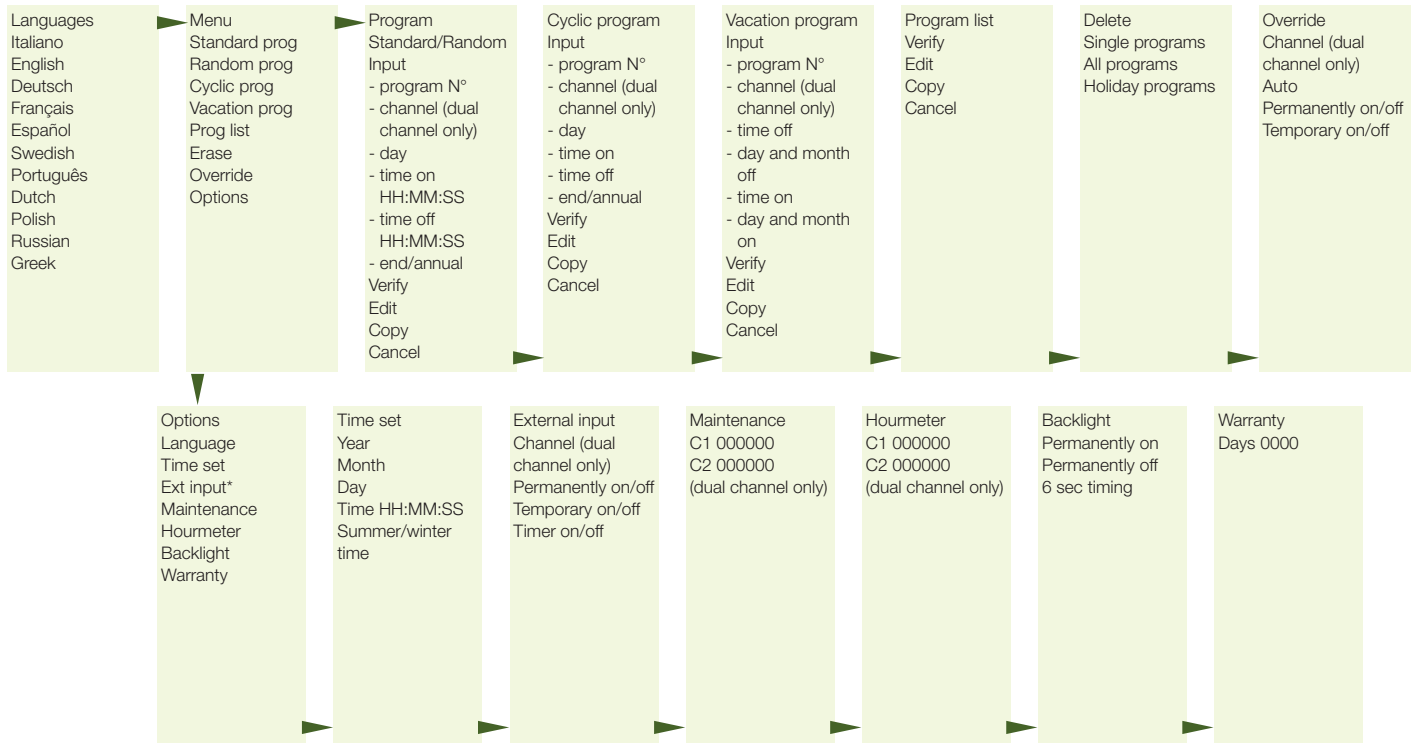

* Excluding SYNCHRO models

Programming menu with programming key

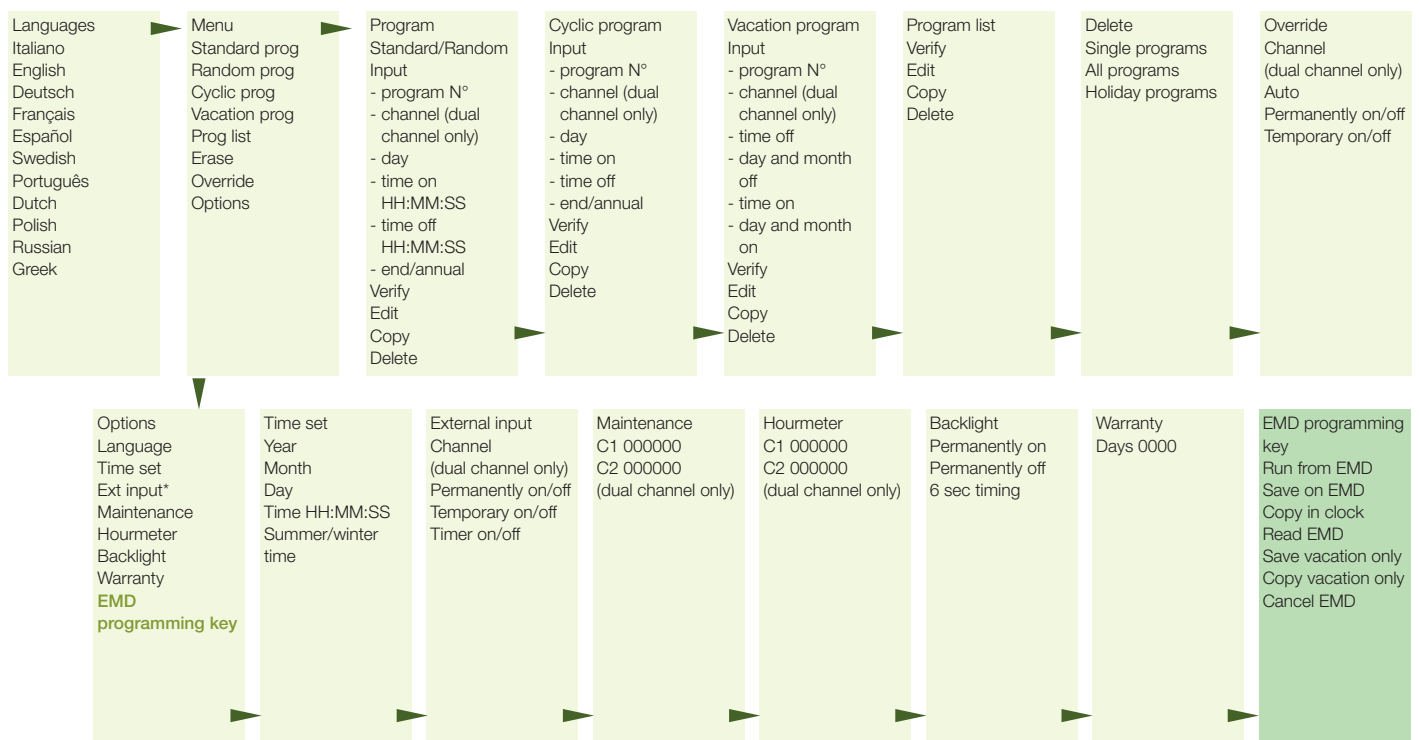

* Excluding SYNCHRO models

D Line digital time switches

Keys and display

Display and function keys

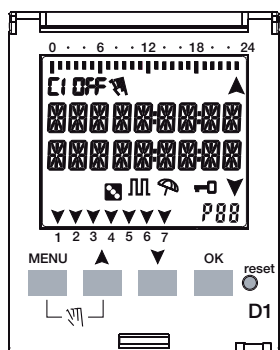

D1

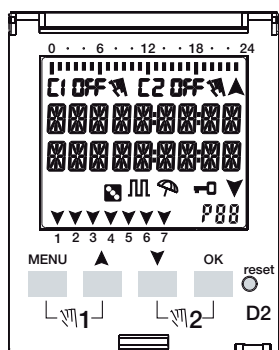

D2

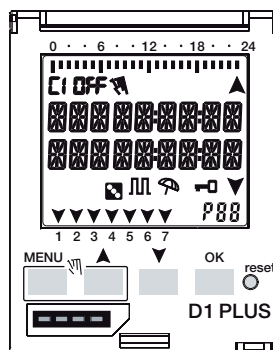

D1 PLUS,
D1 SYNCHRO

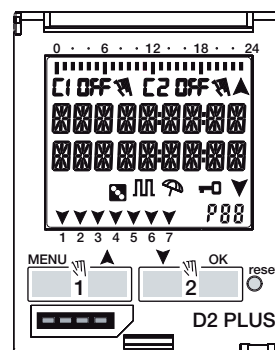

D2 PLUS,
D2 SYNCHRO

Display

	Channel 1 / Channel 2		OFF / Channel off
	Manual channel override		ON / Channel on
	Random program		Cyclic programs
	Vacation program		Keypad locked
	Indication of GPS or DCF77 signal reception		Browse up
	Selected program N° P01-P64		Browse down

Function keys

MENU 	Allows you to access the main menu (from the initial page) Allows you to quit any setting
	Scrolls up a list Increases a numerical value or changes a parameter
	Scrolls down a list Decreases a numerical value or changes a parameter
OK 	Confirms the proposed setting
RESET 	Resets the device (NOTE: The programs and settings entered from the outside will not be cancelled)

Key combination functions

Function	Key combination
Lock/release keys	 2 seconds
Temporary manual override for channels 1 and 2. Press alternately to switch from TEMP ON to TEMP OFF	 2 seconds
Permanent manual override for channels 1 and 2. Press for 2 seconds to access the PERM mode and press alternately to switch from PERM ON to PERM OFF	 2 seconds
Returns to the AUTO mode (if any manual override has been activated)	 2 seconds

D Line digital time switches



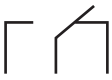

Technical specifications

		D1	D1 PLUS	D1 SYNCHRO	D2	D2 PLUS	D2 SYNCHRO
Rated voltage	V	230 AC + 10%					
Rated pulse voltage	kV	4					
Contact type		Contact relay in free exchange from potential					
Programming key			■	■		■	■
External input			■			■	
DCF77 antenna				■			■
GPS antenna				■			■
Programming software			■	■		■	■
250 V~ contact capacity							
Resistive loads	A	16 16					
Inductive loads	A	10 2					
Rated frequency	Hz	50-60					
Time base		quartz					
Minimum switching time	sec.	1					
Max programs per cycle	n°	64 (can be coupled into day blocks)					
Running reserve	years	6 from first start-up (lithium battery)					
External input	n°	1		-	2		-
Activity suspension		from 1 day to 12 months					
Accuracy	sec./day	0.5 at 25 °C					
Max power consumption	VA	6.5			7.8		
Max switching power	VA	3500					
Incandescent LP power	W	3000					
Non-rephased fluorescent tube LP power	W	1100					
Fluorescent tube LP power rephased in parallel	W	900					
Fluorescent tube LP power with electronic reactor	W	7 ÷ 23 (max. 23 lamp.)					
Fluorescent tube LP power rephased in series	W	1100					
Protection degree	IP	20					
Max terminal section	mm²	6					
Terminals		positive safety loss-proof screws					
Installation type		DIN rail					
Operating temperature	°C	-5 ... +55					
Storage temperature	°C	-10 ... +65					
Modules	n°	2					

		D DCF77	D GPS
Rated voltage	V	230 AC \pm 20%	
Rated frequency	Hz	50/60	
Power consumption	W	0.1	2
Operating temperature	$^{\circ}$ C	-10...+70	-10...+40
Storage temperature	$^{\circ}$ C	-30...+90	-40...+85
Power consumption	VA	9.2	2
Time of the signal		1 transm./ min.	min. 30 transm./hour; max. 50 transm./hour
Protection degree	IP	65	65
Max. number of connected devices	N $^{\circ}$	10	10
Max. wiring lenght	m	1000	1000
Terminal section	mm 2	0.5...2.5	0.5...2.5
Installation		pole/wall	pole/wall

Maximum pilotable power

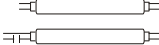
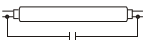
Models D1 - D1 PLUS - D1 SYNCHRO - D2 - D2 PLUS - D2 SYNCHRO

				
3000 W	3000 W	1100 W	900 W (125 μ F)	7 W \div 23 W (max. 23 lamp.)

D Line digital time switches

Operating principle

The D2 two-channel digital time switches enable to open and close circuits according to a daily or weekly program, controlling single loads or group of loads even when they require different time controls with a common time reference. In this example, the digital time switch D2 allows the operation of heating as well as lighting systems of a church when services are performed; when no service is performed, the device only controls the heating system.

Application environments

The D2 two-channel digital time switches are particularly indicated in environments and situations requiring the management of multiple loads according to a time program flexible enough to include or exclude their application based on the day of the week (offices, schools, public areas, etc.).

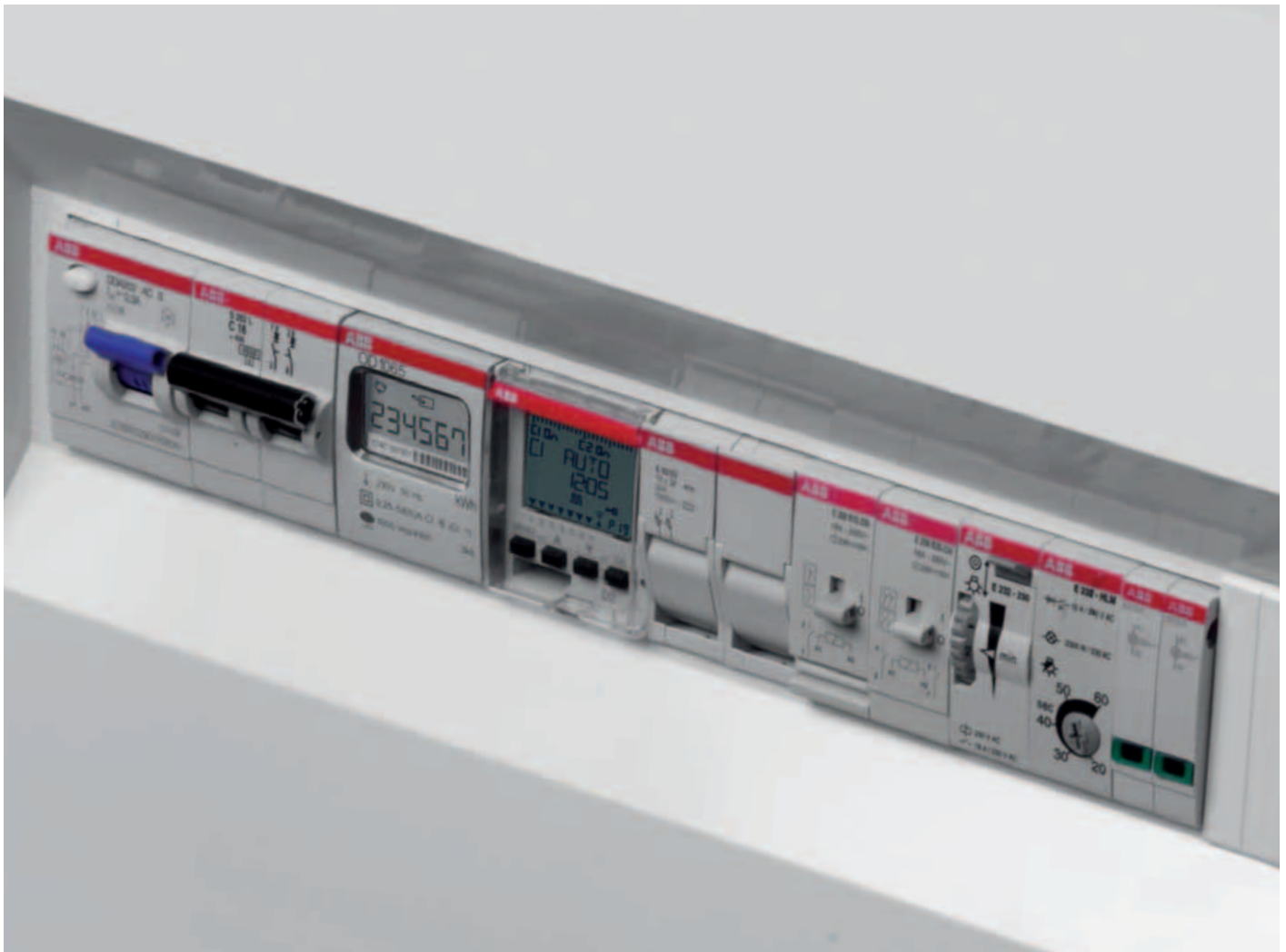

Installation example

As shown in the diagrams, one of the possible applications is to install the D2 two-channel digital time switch inside the power supply circuit of a church, where in the days when no service is performed only the heating system is activated (programmed ON one of the two channels) at a preset time, while on Sundays and when services are performed the lighting system is also switched ON (through a program on the second channel). According to the controlled system power, the activation is performed by an ESB contactor.

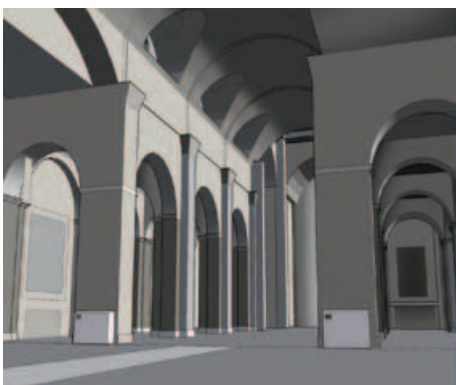
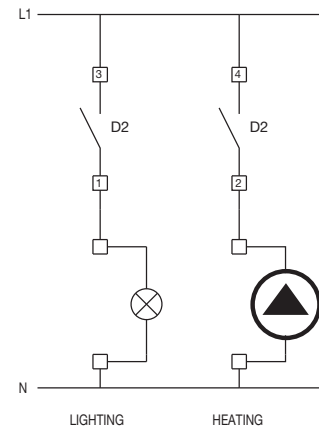
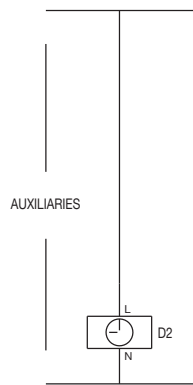
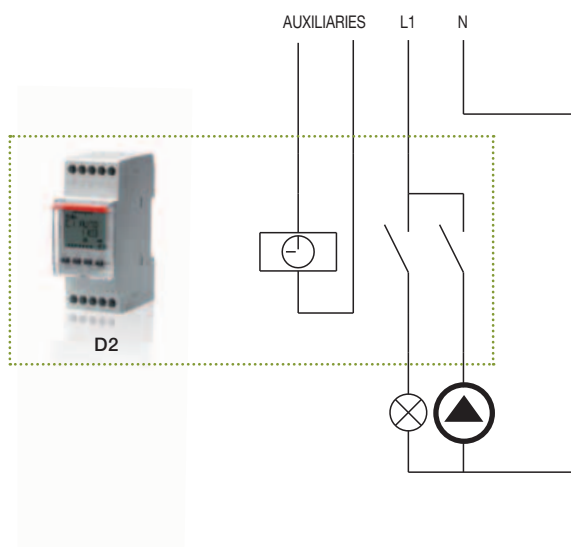

DTS yearly digital time switches

Used for the most sophisticated programming configurations, DTS yearly digital time switches can control multiple loads or even groups of independent loads that require temporally-differentiated commands but with a common time reference.

DTS series yearly digital time switches are available in 3 or 4 channel versions. Used for more sophisticated configurations, they are able to control multiple loads or even groups of independent loads that require time-differentiated commands, but with a common clock reference. An EPROM memory eliminates the risk of program loss in the event of power failure, irrespective of its duration.

DTS yearly digital time switches are ideal in large buildings that have variable needs over the course of the year (public lighting, heating of public buildings, distribution chains, shopping centres, etc...).

DTS time switches can be programmed directly from the user's PC using the DTS/PRG-SW software, which allows quick and easy configuration. The program can in fact be transferred from the PC to a portable memory unit, and then copied from there to multiple devices, thus avoiding reprogramming errors.

DTS/PRG-SW software also allows the device to be used as a conventional astronomical time switch.

By defining the latitude and longitude of the geographical place of installation, it is possible to automatically control the switching of circuits based on the time when the sun rises and sets.

DTS/DCF antenna, used in conjunction with the device, enables it to be automatically synchronised with the official DCF77 Frankfurt time signal, broadcast via long wave radio. The range of the DCF77 signal is about 2500 km from Frankfurt.



DTS yearly digital time switches

Range specifications

Ease of use

- Wiring diagram laser printed on the side of the product
- Load status display
- 400 memory locations allowing even the most complex programming configurations to be handled with ease
- Removable front panel allowing you to program the device while seated comfortably at your desk
- Automatic summer/winter time switch-over

Performance

- Daily, weekly, yearly, vacation, impulsive and cyclic programming modes
- Astronomical function
- Programming key, DCF77 antenna and programming software

Safety

- The lithium battery maintains the settings even in case of power failure
- The EPROM memory prevents program loss during power failure, regardless of how long it lasts.
- Sealable and loss-proof cover to prevent tampering by unauthorized persons

		DTS7/3Y	DTS7/4Y
Rated voltage Un		230 AC +10%/-15%	
Contact type		3NO/NC	4NO/NC
Contact capacity			
Resistive loads	A	16	
Inductive loads	A	2.5	
Rated frequency	Hz	50/60	
Time reference		quartz	
Minimum ON/OFF switching	min	1	
Max. operations per cycle		400	
Pulse duration		1 sec...99 min	
Running reserve	years	6	
Operating accuracy		±1 sec/day	
Power consumption	W	5	
Terminals		with captive screws	
Type of installation		DIN rail	
Protection degree	IP	20	
Operating temperature	°C	-25...+55	
Can be sealed		■	
Modules		6	
Reference Standards		EN 60730-1, IEC 730-1, CEI 107-70, VDE0633	

DTS yearly digital time switches

Command devices and display

Commands

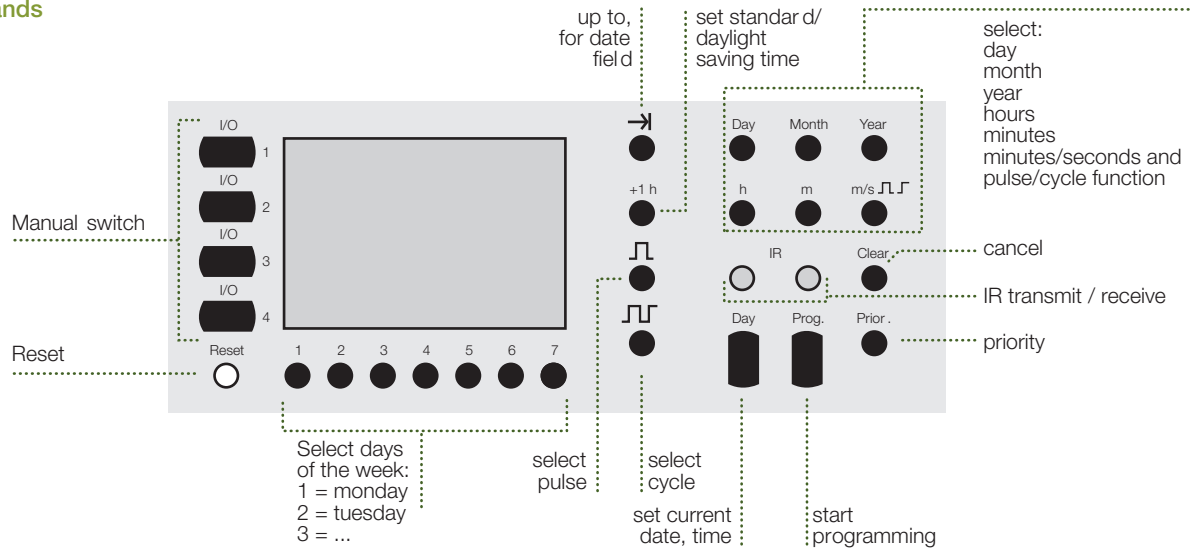

Display

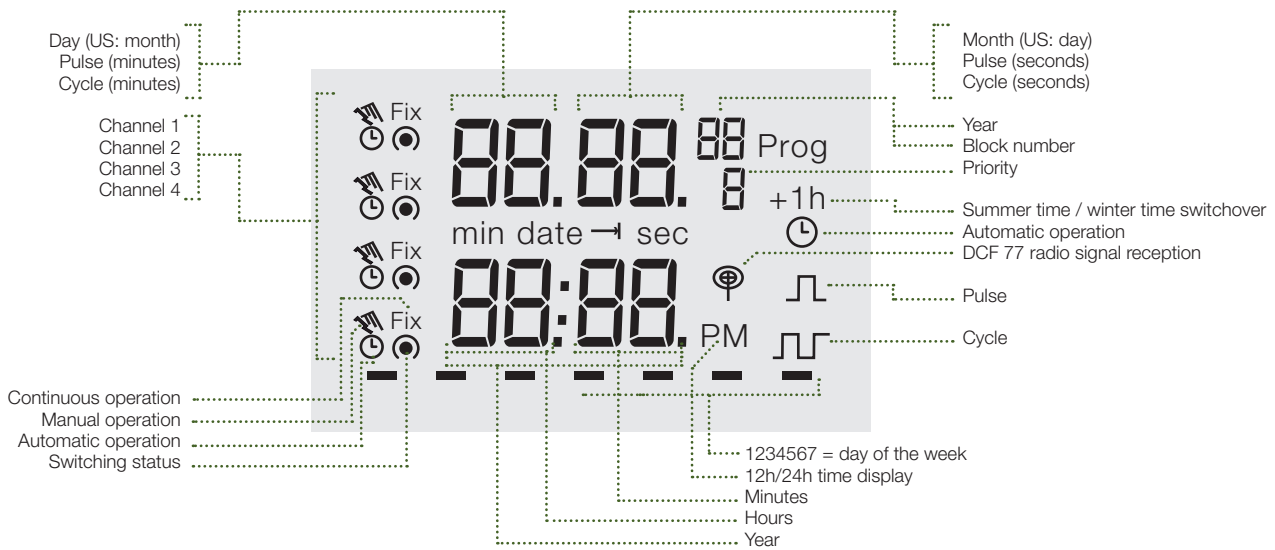

DTS yearly digital time switches

DTS/PRG-SW: easy to install

- 1) Install the DTS/PRG-SW software in your PC. You need a 486 processor or higher, with Windows 95/98/2000/NT/XP and at least 4 MB vacant disk space.
- 2) Connect one end of the serial cable to the serial port of the PC and the other end to the flash drive
- 3) Using the DTS/PRG-SW software, copy the yearly program in the flash drive
- 4) Disconnect the flash drive and insert it into the infrared slot in the device
- 5) Copy the program from the flash drive to the device.

At this point, the flash drive can be removed from the device and the procedure repeated in another device. In addition to pasting programs onto multiple devices, you can also copy a program from the device into the flash drive.

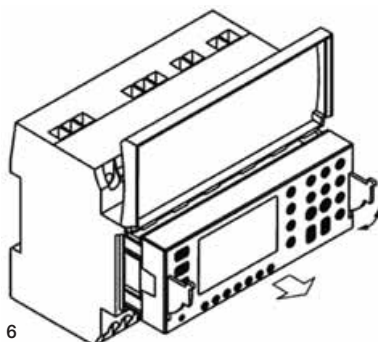
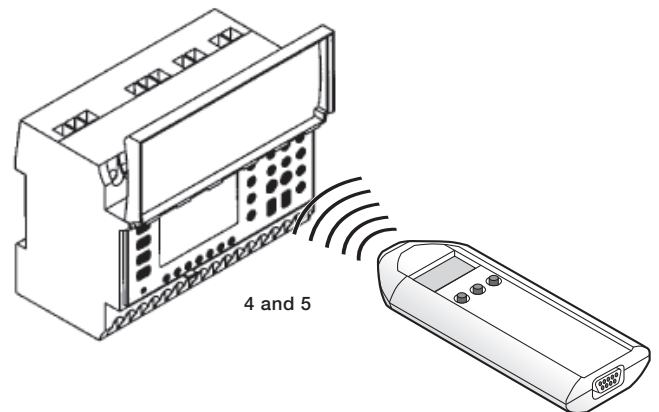
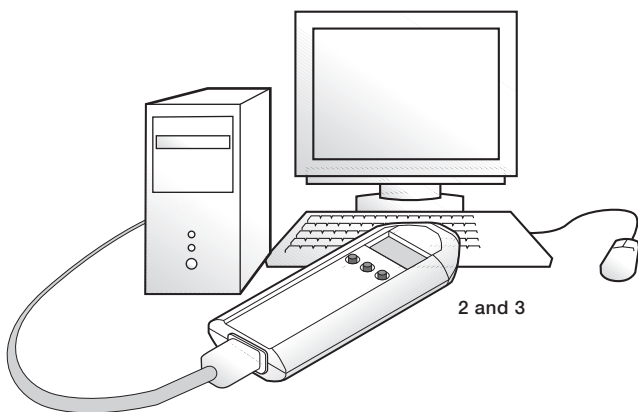
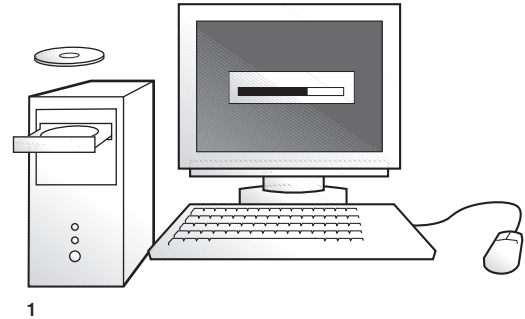

Removable control panel

The removable control panel allows the device to be conveniently programmed at the desk.

DTS yearly digital time switches DTS/PRG-SW programming

The DTS/PRG-SW software allows you to easily program an annual cycle, which can then be transferred to the DTS7/3Y and DTS7/4Y digital timers.

Programming in just a few easy steps

Part one:

- Select the application
- Choose the number of contacts
- Select the contact symbol
- Choose the name
- Enter the rated power

Part two:

- Define the program
- Choose the number of contacts
- Define the switching time
- Enter the type of switching required (ON-OFF, PULSE or CYCLE)
- Add any further information required

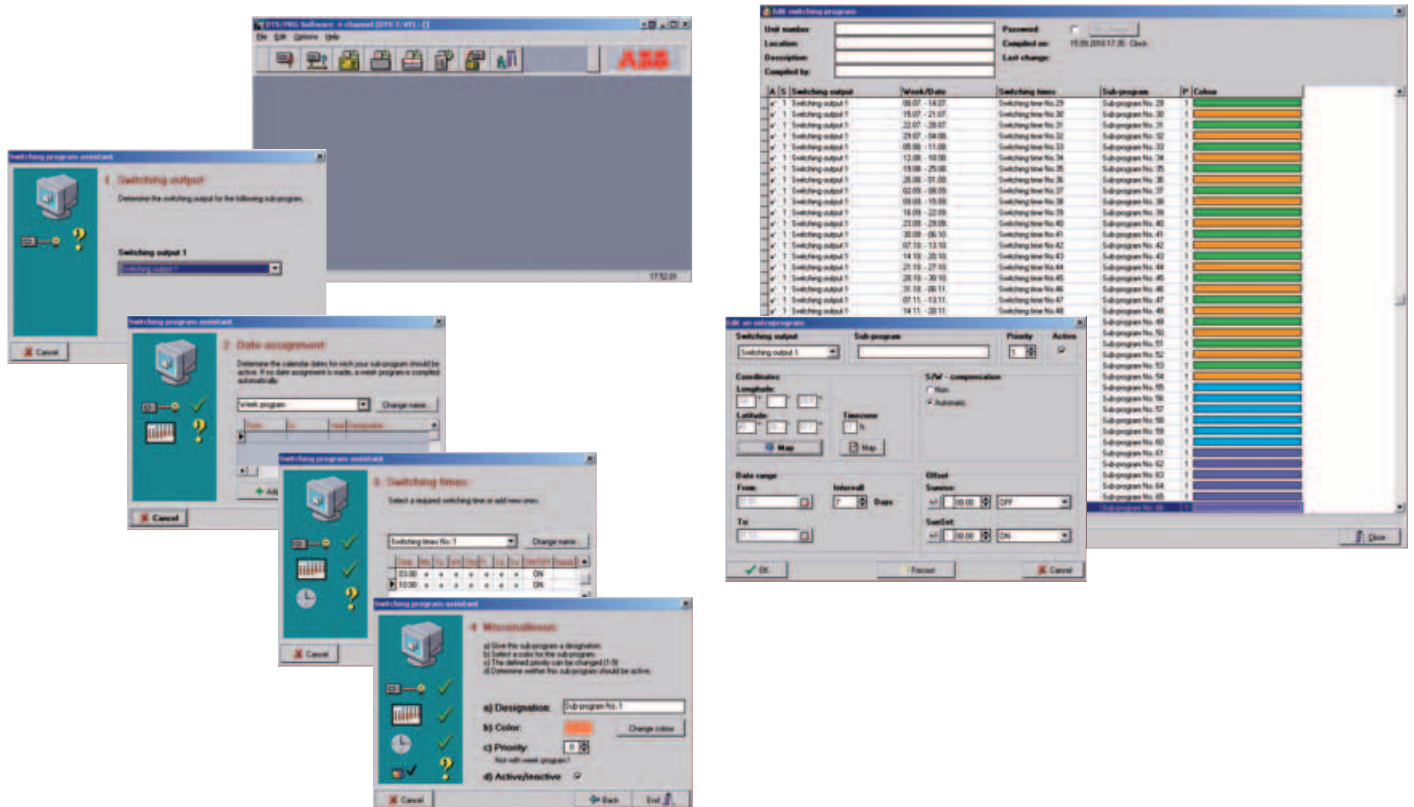

DTS/PRG-SW software can also be used for configuring the astronomical functions, viewing a clear graphical representation of the entire annual program with access to the individual days, as well as for printing a summary of the program to be kept for reference near the device or filed.

Astronomical functions

Using the DTS/PRG-SW software, the DTS7/3Y and DTS7/4Y timers can be configured to control one or more contacts according to the sunrise and sunset times of each day of the year, thus replacing the functions of a conventional twilight switch.

The device will start to operate once the date, time and the latitude and longitude values of the place of installation have been entered

The astronomical functions are ideal when:

- the distance between the sensor and the twilight switch is more than 100 m, or when the sensor cannot be installed (panels installed inside buildings)
- the sensor cannot be installed away from light sources (amusement parks, camp sites, etc.)
- the sensor cannot be installed because it could be subject to interference due to pollution, dirt or vandalism

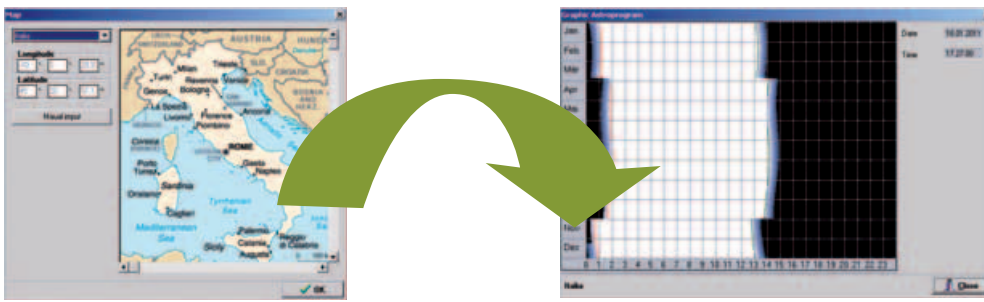

Graphical representations

You can obtain an easily interpreted representation of the annual program and the selected days of the week. The active parts are highlighted in different colours, as can be seen in the figure.

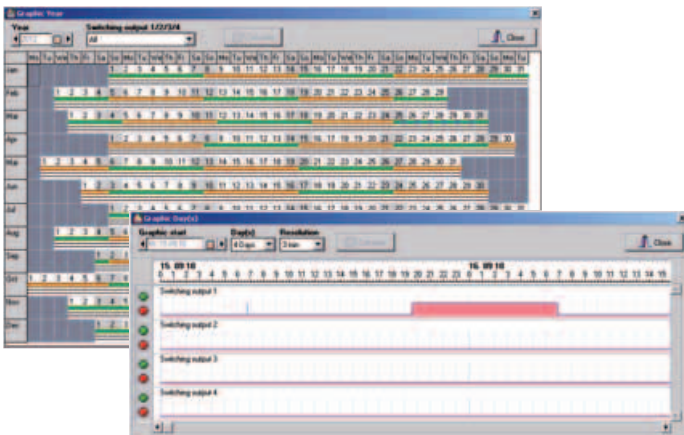

Program summary

Once the program has been defined, you can print out a summary to keep as a reference. The program printout shows the following details:

- Number of switching operations
- Duration of ON and OFF operations
- Pulse duration
- Cycle duration
- Consumption in kWh (requires entry of the correct load values)

Evaluate switching program		
Parameter	Value	Unit
Period	15.09.2010 00:00 Clock	
	16.09.2010 00:00 Clock	
	1 Days 0 h 0 min (24 h 0 min)	
Application	State "ON"	State "OFF"
Switching output 1	Blank	OFF
Switching points	1	0
Duration	4h 22m 43s	19h 37m 16s
Pulse		
Cycle/pulse time		
Power consumption	0.000 kWh	0.000 kWh
Switching output 2	OFF	OFF
Switching points	0	0
Duration	0h 00m 00s	24h 00m 00s
Pulse		
Cycle/pulse time		
Power consumption	0.000 kWh	0.000 kWh
Switching output 3	OFF	OFF
Switching points	0	0
Duration	0h 00m 00s	24h 00m 00s
Pulse		

DTS yearly digital time switches

Operating principle

As shown in the diagrams, one of the possible applications is to mount the D2 two-channel digital time switch inside the power supply circuit of a church, where in the days when no service is performed only the heating system is activated (programmed on one of the two channels) at a preset time, while on Sundays and when services are performed the lighting system is also switched on (through a program on the second channel). According to the controlled system power, the activation is performed by an ESB contactor.

Application environments

The installation of a DTS annual digital timer switch is especially suited for schools, hospitals, train stations, airports, industrial factories, public buildings, malls, etc. where the perfect operations of all devices are required at a set time.



Installation example

As shown in the diagrams, one of the possible applications is the installation of a DTS7/4Y 4-channel annual digital timer switch in a small power circuit where lighting, heating and escalators run from morning till night on work days with the periodic activation of a siren at closing hours. The ample clock memory space allows you to automate the system for the entire year, setting all holidays when loads are left off and thus saving energy and avoiding the risks of error in reprogramming. Combination with a DTS/DCF antenna also allows you to keep the clock constantly synchronised with the precise time, avoiding any time changes.

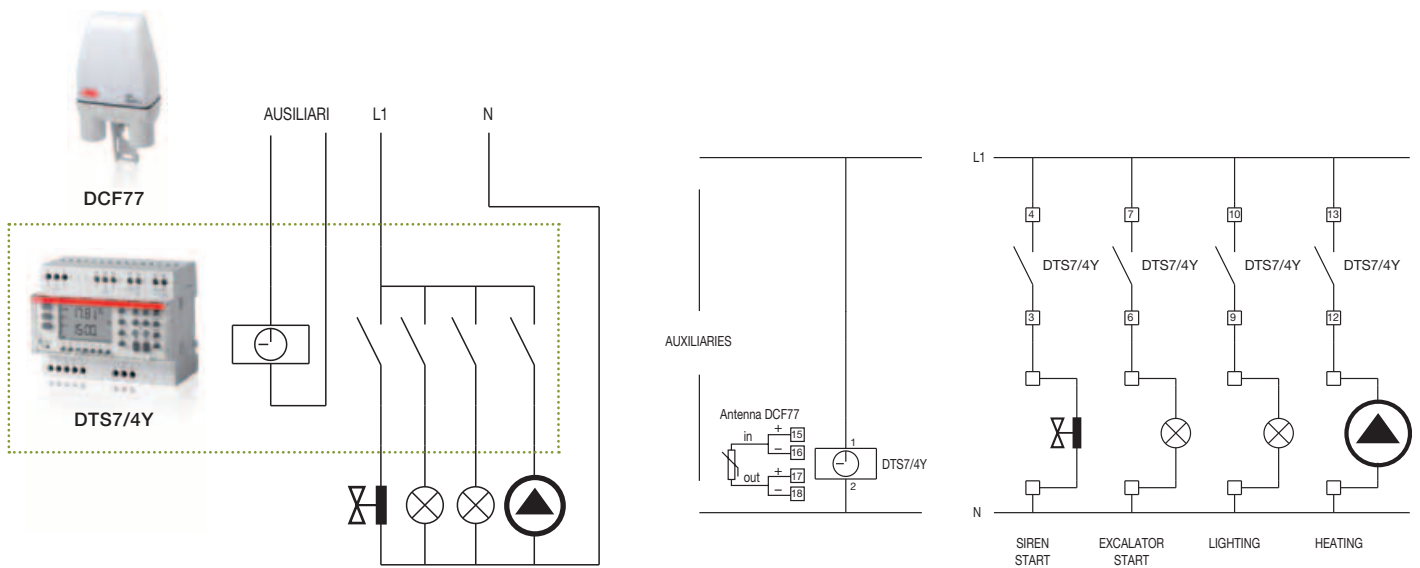

E 232 staircase lighting time-delay switches with switch-off warning

ABB's E 232 staircase lighting switches comprise electro-mechanical and electronic versions, with 3 or 4-wire wiring. These devices are ideal for timed management of lights in passageways (corridors, staircases, entrances, etc.).



Staircase lighting time-delay switches are generally controlled by pushbuttons equipped with glow lamps. Designed for a glow lamp current up to 150mA, they can be used in buildings with several floors.

The E 232 staircase lighting switch is equipped with an electro-mechanical timer with a synchronous motor drive that guarantees highly reliable operation in whatever position it is installed. The switch-off time can be regulated from 1 to 7 minutes at intervals of 15 seconds and is resettable after 30 seconds.

The E 232E staircase lighting switch has an electronic timing function. The most important features of the device are: a high switching capacity; 150 mA filament lamp current parallel to the pushbuttons; switch-off time adjustable from 0.5 to 20 minutes; simple use; the new, extremely silent, precise and reliable electronic motor. The electronics allow the device to automatically recognize 3-wire systems from 4-wire ones without the need for manual settings.

E 232E-8/230 devices feature an additional, separate control input with an universal voltage of 8 to 230 V AC/DC. The "Multi 10" versions also feature the integrated alarm function (2 flashing alarm signals) in accordance with DIN 18015-2 standards and a rotary selector on the front with 10 functions to choose from, divided into 4 types: timed relay mode, latching relay mode, timed latching relay mode and permanently on mode.

The E 232-HLM accessory, which can be used in conjunction with the E 232-230, E 232E-230N and E 232E-8/230N series, allows a switch-off warning device to be activated. This dims the light intensity by 50% once the time setting of the staircase lighting switch has elapsed: the adjustable time range is 20 to 60 seconds.



Technical specifications

- Silent: thanks to the new electronic relay
- Practical: automatically recognizes 3 or 4-wire systems
- Powerful: switching capacity up to 3,600 VA lamp load thanks to the pioneering type of switching mode, and powers up to 150mA glow lamp current of lighten pushbuttons thanks to the pioneering type of switching mode, and powers up to 150 mA of lighted pushbuttons
- Flexible: 0.5 to 20 minute adjustable switch-off time
- Versatile: 8 to 230 V multivoltage auxiliary input

Further advantages of the new Multi 10 version

- Universal: four different functions, for every requirement
- Programmable: ten different operating modes
- Complete: with integrated switch-off warning

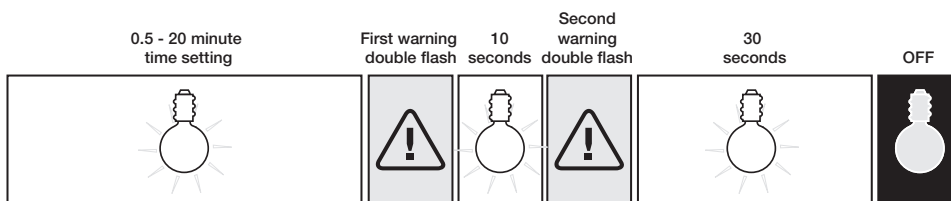

The additional switch-off warning can be added to the main modes of the Multi 10 versions.

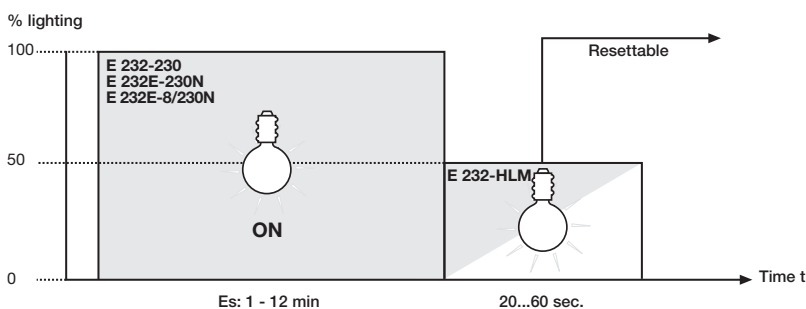





Switch-off warning function of an E 232-HLM staircase lighting switch in conjunction with a timer

This function prevents the staircase light from switching off and leaving the user suddenly in the dark, when he's halfway up the stairs. The function is displayed by a double flash of the lights, in accordance with DIN 18015-2 standards and is compatible with halogen or filament lamps.

The switch-off warning function can only be obtained for the other versions in conjunction with the E 232-HLM automatic staircase lighting switch. This device allows the lights to switch on for 60 minutes for causes due to stair maintenance for example, and is obtained by pressing and holding (> 2 seconds) the staircase light button. The function can be activated with the selector on the front of the device.

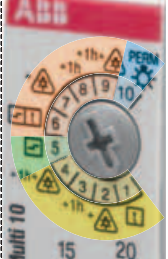
E 232 staircase lighting time-delay switches with switch-off warning

The “Multi 10” version also features the integrated alarm function (2 flashing alarm signals) in accordance with DIN 18015-2 standards and a rotary selector on the front with 10 functions to choose from, divided into 4 types, depending on the user’s requirements: timed relay mode, latching relay mode, timed latching relay mode and permanently on mode.

	Timed relay mode (positions 1 to 4)	
	Latching relay mode (position 5)	
	Timed latching relay mode (positions 6 to 9)	
	Permanently on mode (position 10)	

Timed relay mode (positions 1 to 4)

This mode allows the user to turn on the lights by briefly pressing one of the staircase light buttons. The light remains on until the automatic switch-off time setting has elapsed (the device goes back to counting from 0 if a staircase light button is pressed while the lights are on).

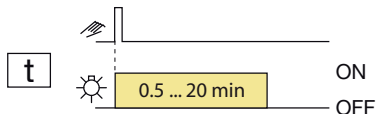
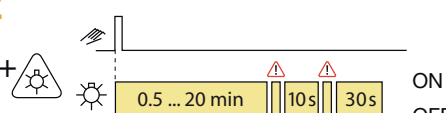
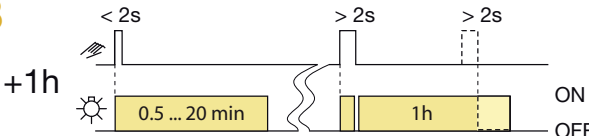
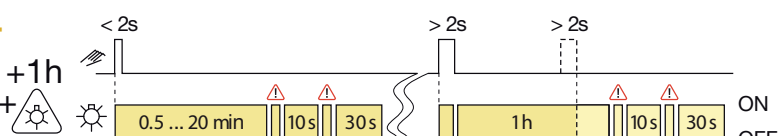
<p>1</p> 	<ul style="list-style-type: none"> - Automatic staircase light switch - Lighting time reset by pressing keys again
<p>2</p> 	<ul style="list-style-type: none"> - Automatic staircase light switch - Lighting time reset by pressing keys again - Switch-off warning
<p>3</p> 	<ul style="list-style-type: none"> - Automatic staircase light switch - Lighting time reset by pressing keys again - 60-minute switch-on by pressing keys and holding down > 25
<p>4</p> 	<ul style="list-style-type: none"> - Automatic staircase light switch - Lighting time reset by pressing keys again - Switch-off warning - 60-minute switch-on by pressing keys and holding down > 25

Latching relay mode (position 5)

This mode allows the user to turn on the lights by briefly pressing one of the staircase light buttons. The light remains on until the buttons are pressed again.

<p>5</p> 	<ul style="list-style-type: none"> - Latching relay
---	--

Timed latching relay mode (Positions 6 to 9)

This mode allows the user to turn on the lights by briefly pressing one of the staircase light buttons. The light remains on until the set time has elapsed or the staircase light buttons are pressed again.

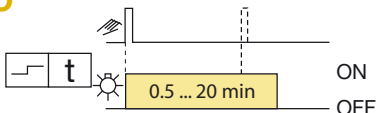
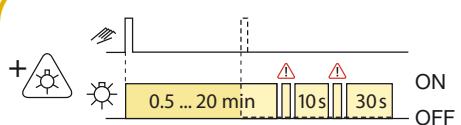
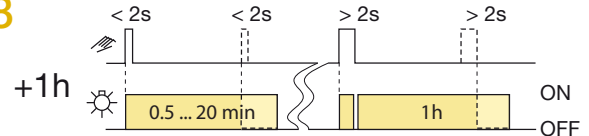
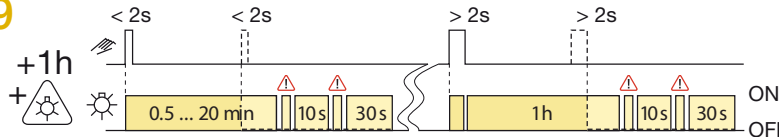
<p>6</p> 	<ul style="list-style-type: none"> - Timed latching relay - Switch-off in advance by pressing the keys
<p>7</p> 	<ul style="list-style-type: none"> - Timed latching relay - Switch-off in advance by pressing the keys - Switch-off warning
<p>8</p> 	<ul style="list-style-type: none"> - Timed latching relay - Switch-off in advance by pressing the keys - 60-minute switch-on by pressing keys and holding down > 2s
<p>9</p> 	<ul style="list-style-type: none"> - Timed latching relay - Switch-off in advance by pressing the keys - Switch-off warning - 60-minute switch-on by pressing keys and holding down > 2s

Permanently on mode (position 10)

The lights remain continuously on when the selector is set to position 10.

<p>10</p> <p>PERM</p> 	<ul style="list-style-type: none"> - Continuous light
--	--

E 232 staircase lighting time-delay switches with switch-off warning

Technical specifications

		E 232-230	E 232-HLM	E 232E-230N	E 232E-8/230N	E 232E-230 Multi 10	E 232E-8/230 Multi 10
Type		electro-mechanical	electro-mechanical	electronic	electronic	electronic	electronic
Time range	min	1-7	20...60 sec	from 0.5 to 20 stepless	from 0.5 to 20 stepless	from 0.5 to 20 stepless	from 0.5 to 20 stepless
Automatic recognition of 3/4-wire systems				■	■	■	■
Connection in series available		■	■	■	■	■	■
Steady-light switch		■		■	■	■	■
Switch-off warning (after flashing)						■	■
Switch-off warning (50% dimming)			■			■	■
30 sec. to 20 min adjustment						■	■
60 min long-time range						■	■
Switching on zero crossing of voltage						■	■
Count reset by pressing buttons		after 30 sec.	no	immediate	immediate	immediate	immediate
230 V AC control voltage		■	■	■	■	■	■
Rated frequency	Hz	50	50...60	50...60	50...60	50...60	50...60
Power consumption	VA	1	6	6	6	6	6
Additional universal voltage	V AC/DC	-	-	-	8...230	-	8...230
Glow lamp current	mA	max. 50	-	max. 150	max. 150	max. 150	max. 150
Contact capacity	A						
Rated switching capacity		16A/230V AC	10A/230V AC	16A/230V AC	16A/230V AC	16A/230V AC	16A/230V AC
Filament lamp load	W	2300	2300	2300	2300	3600	3600
Halogen lamp load	W	2300	2300	2300	2300	3600	3600
Fluorescent lamp with capacitive reactor							
not compensated	VA	2300	not permitted	2300	2300	3600	3600
compensated in series	VA	2300	not permitted	2300	2300	3600	3600
compensated in parallel	VA	1300	not permitted	400	400	1200	1200
duo circuit	VA	2300	not permitted	2300	2300	3600	3600
Fluorescent lamps with electronic reactor	VA	300	not permitted	300	300	1000	1000
Energy-efficient fluorescent lamps							
with capacitive reactor	VA	1,500	not permitted	1,500	1,500	1,500	1,500
with electronic reactor	n°/W	9x7, 6x11, 5x15, 5x20	not permitted	9x7, 7x11, 7x20, 7x23	9x7, 7x11, 7x20, 7x23	34x7, 27x11, 24x15, 22x23	34x7, 27x11, 24x15, 22x23
Contact material		Ag Sn O ₂	Ag Sn O ₂	Ag Sn O ₂	Ag Sn O ₂	Ag Sn O ₂	Ag Sn O ₂
Contact gap	mm	≥ 3	< 3	< 3	< 3	< 3	< 3
Mechanical life	n°	> 10 ⁶	> 10 ⁷	> 10 ⁷	> 10 ⁷	> 10 ⁷	> 10 ⁷
Electrical life at rated load cosφ = 1	n°	> 10 ⁵	> 10 ⁵	2 x 10 ⁵	2 x 10 ⁵	2 x 10 ⁵	2 x 10 ⁵
Electrical life at rated load cosφ = 0.6	n°	> 10 ⁴	> 10 ⁴	4 x 10 ⁴	4 x 10 ⁴	4 x 10 ⁴	4x10 ⁴
Contact type		1 NO	1 NO	1 NO	1 NO	1 NO	1 NO
Terminal section	mm ²	10	13	13	13	13	13
Max cable section	mm ²	6	6	6	6	6	6
Min cable section	mm ²	0.5	0.5	0.5	0.5	0.5	0.5
Reset interval		resettable after 30 seconds	100%	100%	100%	100%	100%
Housing material		heat-resistant, self-extinguishing, flame-retardant thermoplastic material					
Ambient temperature	°C	-10...+50	-10...+50	-25...+50	-25...+50	-25...+50	-25...+50
Protection degree		IP20	IP20	IP20	IP20	IP20	IP20
Insulation class after installation		II	II	II	II	II	II
Modules		1	1	1	1	1	1
Marking		VDE	VDE	VDE	VDE	VDE	VDE
Mounting		on DIN rail					

E 232 staircase lighting time-delay switches with switch-off warning

Operating principle

Activated by a pulse command via a pushbutton, the E 232 staircase light switch turns on the installation's lights for a time T_1 . In order to avoid an unexpected darkness the Multi10 devices are equipped with a switch-off warning (double flash). For the standard devices this functionality can be realized with the half light module HLM in parallel, dimming the light by 50%.

Application environments

Installation of the E 232 staircase lighting with switch-off warning functionality is ideal wherever the lighting must be timed and unexpected darkness must be avoided (staircases and passageways in public places, cellars, garages, etc.).

Installation example

As illustrated, one among the possible applications concern installation of the E 232 staircase switch, coupled to a HLM half-light module, in the staircase lighting plant of a multistory building. Pushing the push-button, the timer of the E 232 switch turns on the lights for a settable T_1 time. At the end of T_1 time, the HLM half-light module dims the light by a 50% for a T_2 time in the while is possible turn on again the full lighting.

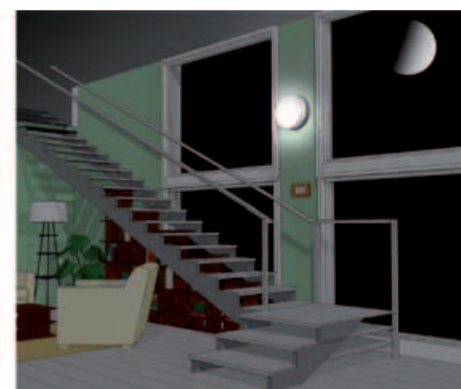
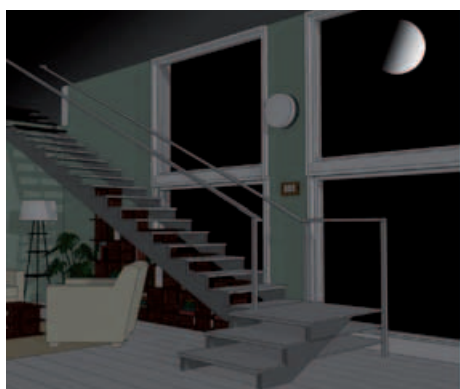
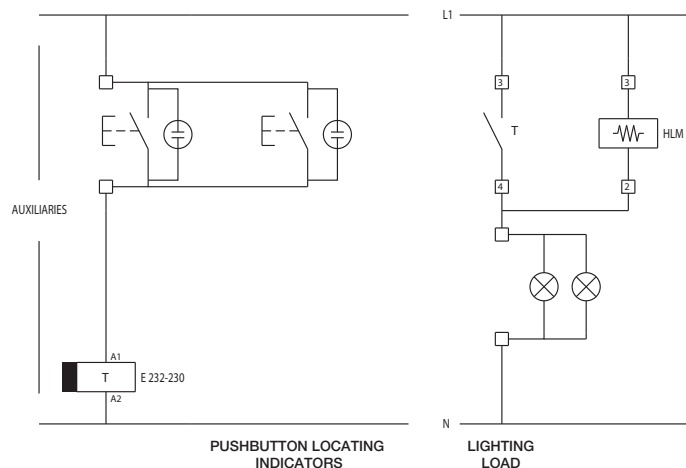
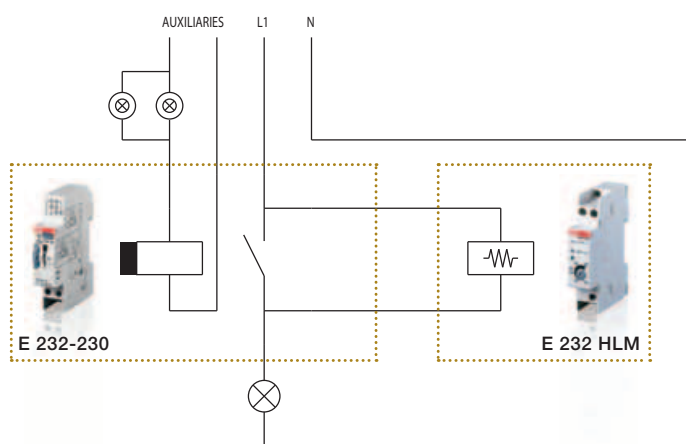

TW twilight switches

TW twilight switches command lighting circuits according to the scheduled level of the ambient light detected by a dedicated sensor. Since they are energy-efficient, they are particularly useful in public places (gardens, parking lots, entrances, courtyards, etc.).

These twilight switches allow to switch on and switch off lighting devices according to a scheduled level of the ambient light. They are used in combination with a sensor to detect if the ambient light is higher or lower than the set level. A switching delay prevents them from operating unnecessarily when the light intensity suddenly changes (e.g. lightning, moving vehicles, etc.).

The TW1 twilight switch in 1 channel is preset a 10 LUX from factory and is equipped with 2 signalling LEDs that indicate the setpoint value and display the status of the contact. The operating instructions are printed on the side of the product.

TW2/10K switches feature a setpoint that can be adjusted for 3 different scale values (2:100, 2:1,000, 2:10,000). This makes them ideal for daytime applications where the Lux values are very high. With a 10 lux preset factory setting, they are equipped with 2 signalling LEDs that indicate the setpoint value and display the status of the contact.

Astronomical switches TWA-1 and TWA-2 with 1 and 2 channels respectively, automatically command lighting circuits according to the time the sun rises and sets. The switches are programmed by defining the longitude and latitude of the geographical area in which they are installed. These devices are especially suitable when use of a twilight switch with external sensor is inadvisable since it could be liable to faults caused by atmospheric pollution, excessive luminosity, or vandalism.

The LS-SP external sensor with housing in thermoplastic material is UV-resistant in its upper part so as to ensure a more uniform diffusion of the light inside.

TWP switches are pre-engineered for installation on poles or walls. They have an integrated internal light-sensitive element, are provided with a 10 lux factory presetting and are ideal for installation in outdoor and street lighting systems. They are equipped with waterproof cable clamps, operating instructions printed on the rear of the product and withdrawable sensor that maintains the wiring and ensures fast, safe and error-free servicing work.



Why are the switches given a 10 lux factory presetting?

Public lighting provides an essential function in social life and for public administrations, is an obligatory outlay without a direct return on the investment.

This means that both cost and management must be optimized while guaranteeing an efficient service. Thanks to the 10 lux factory setting, a standard value for street lighting, ABB's twilight switches are ready for immediate installation in public lighting systems and need no adjustment.

TW twilight switches

Technical specifications

			TW1	TW2/10K	TWA-1	TWA-2	TWP
Rated voltage	V AC		230		230 ± 15%		230
Contact type			1 NO	1 NO/NC	1 NO/NC	2 NO/NC	1 NO polarized
Contact capacity							
Resistive loads	A				16		
Inductive loads $\cos\varphi$ 0.6	A		3		10		3
Filament lamps	$\cos\varphi$ 1		max. 960 W	max. 1080 W	–	–	max. 960 W
Fluorescent lamps	$\cos\varphi$ 0.8		max. 720 W	max. 720 W	–	–	max. 720 W
Fluor.duo/electronic lamps	$\cos\varphi$ 0.9		max. 200 W	max. 200 W	–	–	max. 200 W
Frequency	Hz				50-60		
Switching delay							
on switch-on	s		8 ± 10%		–	–	25 ± 10%
on switch-off	s		38±10%		–	–	25 ± 10%
Adjustment range	lux		2:100	2:100 2:1.000 2:10.000	–	–	2:200
Time reference					quartz		
Minimum switching time	min				1		
Max. operations per cycle					56		
Running reserve	years				5		
Operating accuracy					± 1.5 sec/24h		
Astronomical time precision	min				± 10		
Protection degree	switch		IP20		IP20		IP65
	sensor		IP65		–	–	IP65
Operating temperature	switch	°C	0...+55	0...+55	-10...+55		-30...+50
	sensor	°C		-30...+65			-30...+50
Storage temperature	switch	°C	-10...+65	-10...+65	-20...+60		-30...+50
	sensor	°C		-40...+75	–	–	-30...+50
Power consumption	VA		4.5	2.5	6		7.5
Max switching power	W		3500		4000		3500
Max section of cables at terminals	mm ²		2.5		1..6		2.5
Terminals					with captive screws		screw type
Type of installation					on DIN rail		on pole
Switching status indication/ brightness range			red/green led		–	–	-/ red led
Max wiring length	m		100		–	–	–
Modules			1		2		–
Reference Standards			EN 60669-1; EN 60669-2-1		NFC 15 100; IEC 60 634-1		EN 60669-1; EN 60669-2-1



2300 W (23 x 100 W)



700 W (12 x 58 W)

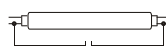

290 W (5 x 58 W 35 µF)



105 W (7 x 15 W)

TW twilight switches

Operating principle

TW1 and TW2/10K

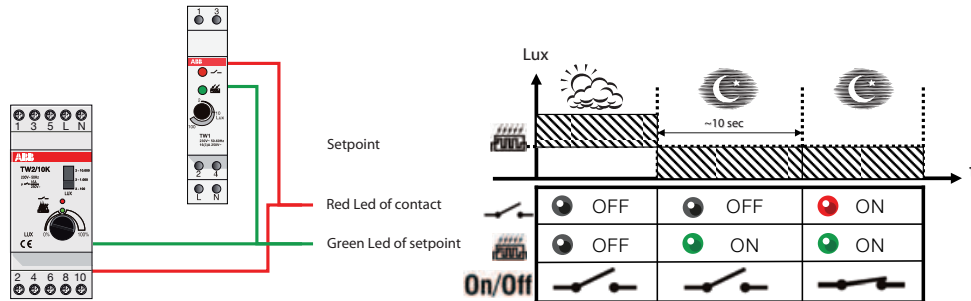

TWP

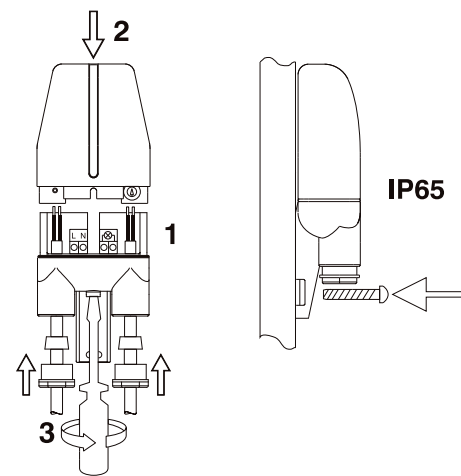
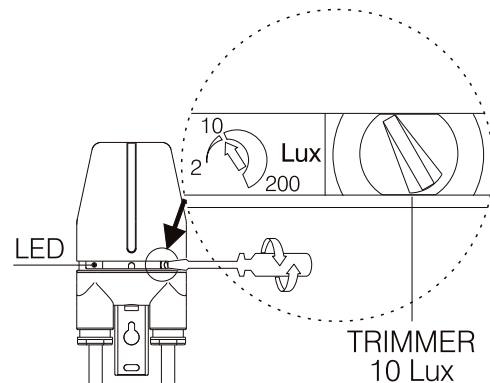

Threshold adjustment

TWA-1 and TWA-2

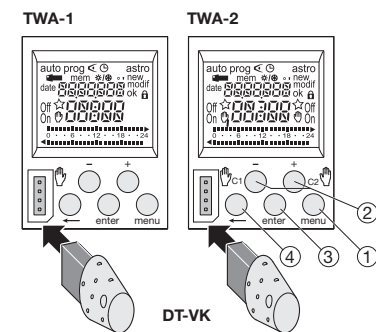

Ex: Rome

- Lo Longitude 12° EAST
- La Latitude 41° NORTH
- UDT +1 Universal Date Time = +1 hour

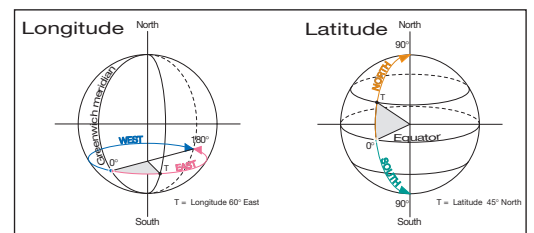

Keys

- ① menu : selection of operating mode.
- auto : mode of running according to the program selected.
- prog : new for programming mode.
- prog : modif to modify an existing program.
- ◀ : checking of the program.
- 🕒 : modification of time, date and selection of the winter/summer timechange mode ☀/🌙
- astro : astronomical mode.
- ☆ : indicates that the channel is in astronomical mode.
- ② + and - : navigation or setting of values. (TWA-1)
- C1 ⏏, C2 ⏏ (TWA-2) : in auto mode, selection of overrides, or waivers.
- ③ enter : to validate flashing information on display.
- ④ ← : to return to the previous step.

Programming

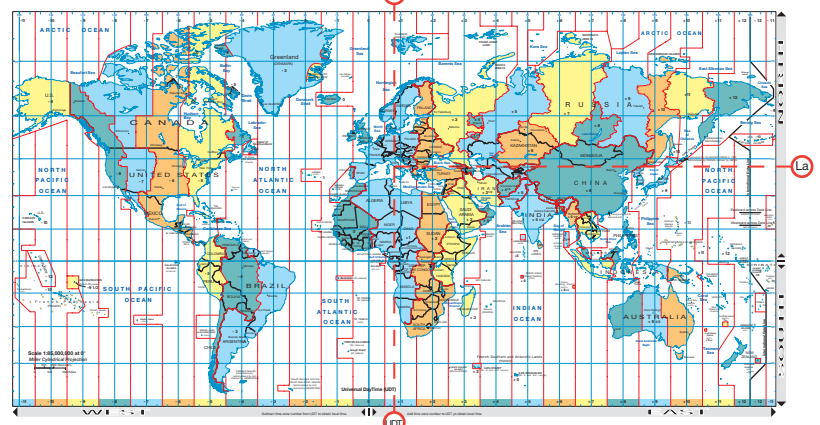

Programming parameters

TW twilight switches

Operating principle

The diagram is an example of a TWI twilight device installed in a mall lighting system. When outdoor light drops under a certain level (for example, in the evening store closing hours), the device turns on window and sign lights. Lights can be turned off during the night to rationalise consumption thanks to the AT1 timer switch.

Application environments

The installation of a TW1 twilight switch with AT electromechanical timer switch is especially suited for environments and situations in which energy consumption rationalisation is required (stores, office and public walkways, car parks, parks, etc.).



Installation example

As shown in the diagrams, one of the possible applications consists in the installation of a TW1 twilight switch in a mall lighting system. When outdoor light drops under a certain level (for example, in the evening store closing hours), the twilight switch turns on window and sign lights. Lights can be turned off during the night thanks to the AT1 timer switch which keeps the circuit open until the next morning. When outdoor lighting returns over the limit, the twilight relay returns to the open position.

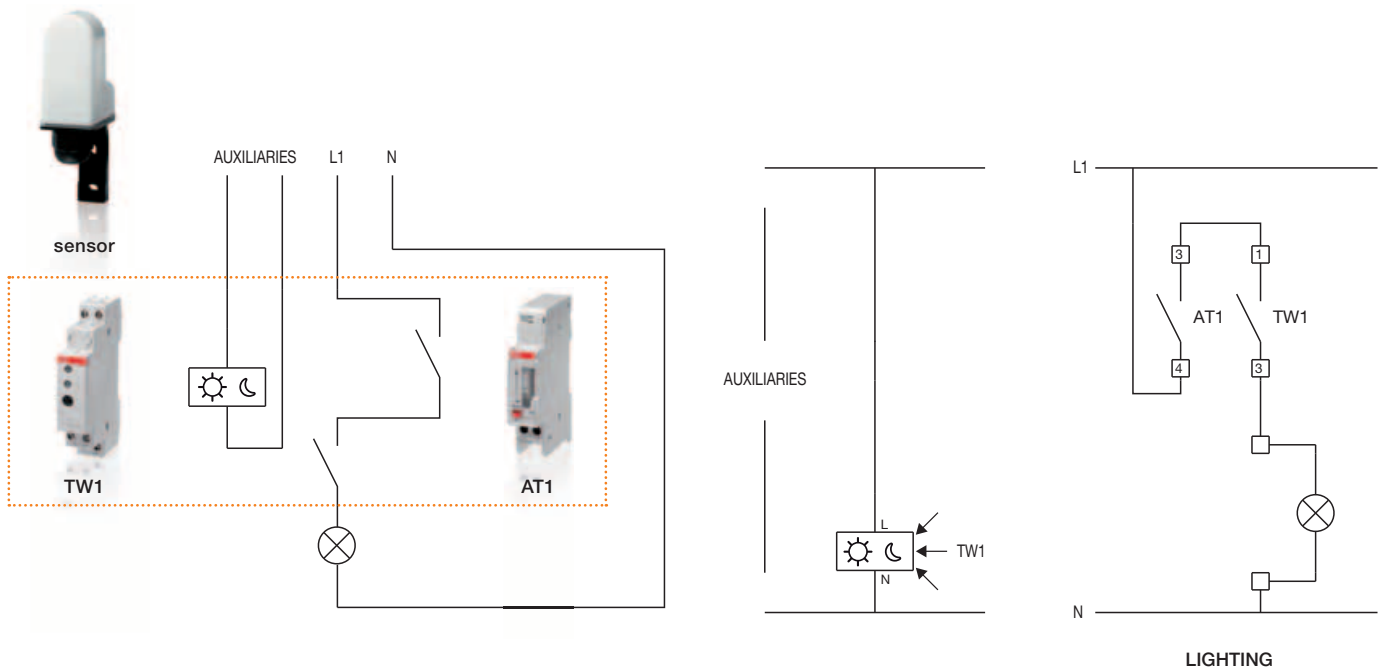

TW twilight switches

Operating principle

Installation of a twilight astronomical switch in a system is particularly useful in places and situations where light sources or other environmental conditions may cause changes in the Lux level. In these cases, TWA-1 and TWA-2 enable control of the lighting system depending on the time when the sun rises and sets, based on the geographic location where they are installed.

Application environments

The TWA-1 and TWA-2 twilight astronomical switches are particularly suitable for use in applications where the operation of a twilight switch with external sensor is potentially subject to alteration or damage from external agents (e.g. smog, overexposure to light, vandalism etc.).



Installation example

One cause of reductions in the level of ambient light is atmospheric smog. Particle deposits on the external sensor of a traditional twilight switch can over time compromise its operation, preventing the activation of the lighting systems controlled. As illustrated in the diagrams, it is possible to counter this type of problem by installing a TWA twilight astronomical switch, which controls the lighting based on the ambient light level calculated from the preset longitude and latitude parameters.

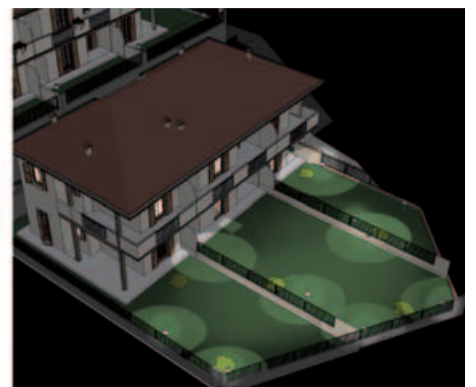
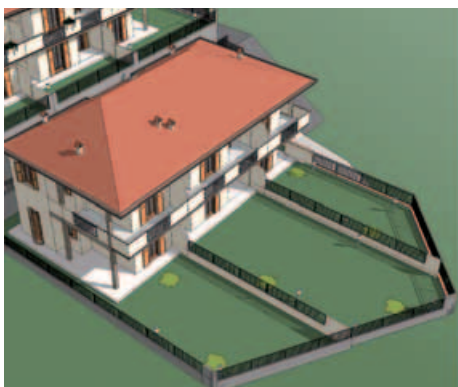
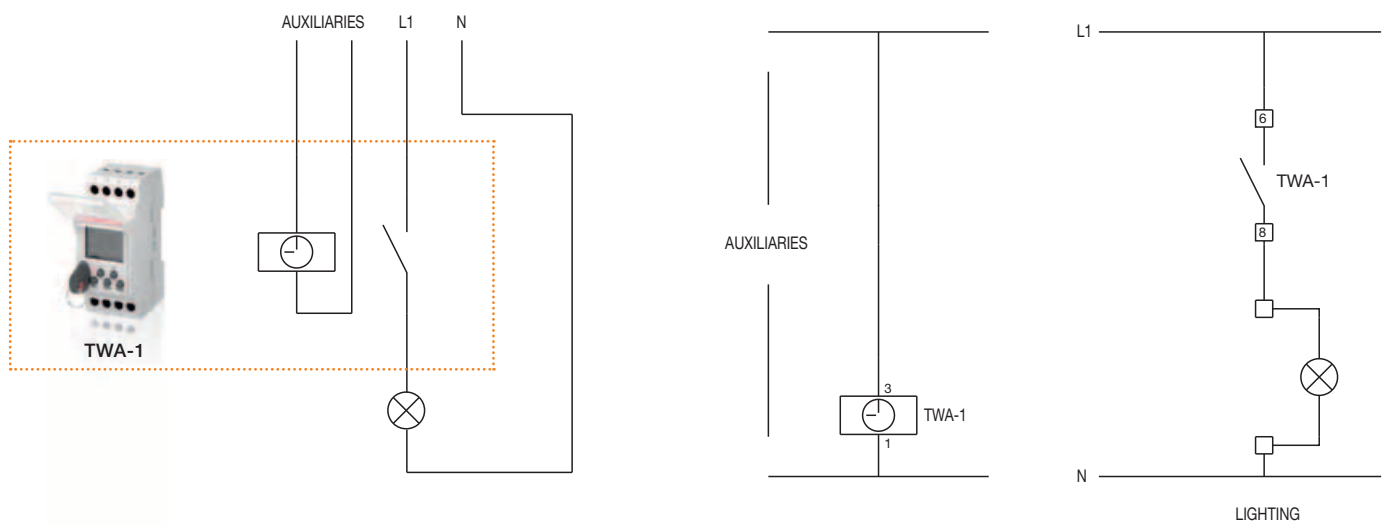

TWP twilight switches

Operating principle

This diagram is an example of the installation of a pole mounting TWP twilight switch in a highways lighting plant. When the daylight dims below a set level, i.e. below 10 lux, the device turns on the lighting devices in tunnels, service areas, access road, etc. TWP will turn off the lights when morning daylight raise above 10 lux.

Application environments

The pole mounting TWP twilight switch installation can be ideal to light command in public roadways thanks to its capability of installation in pole, lamppost, etc.

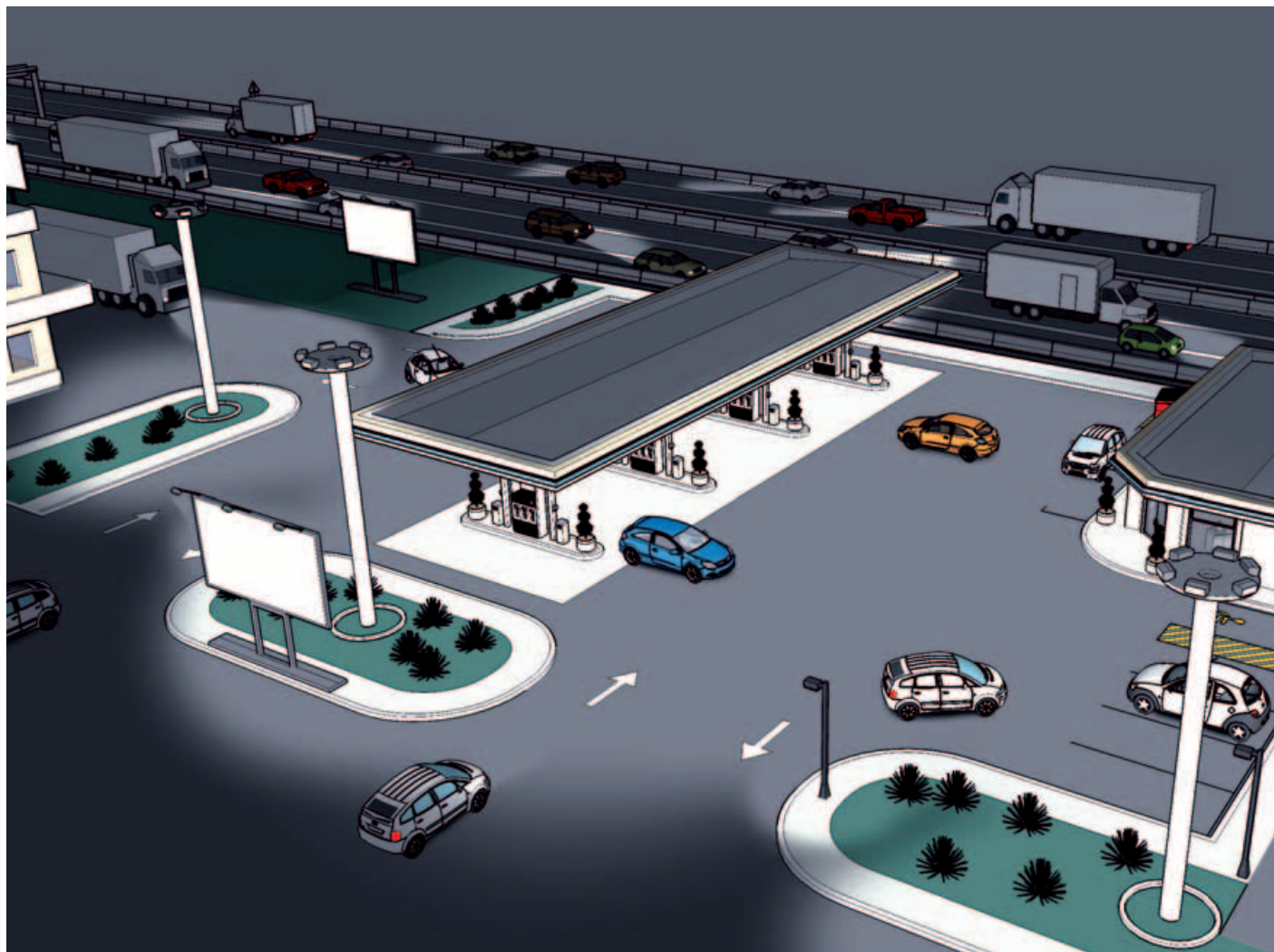

Installation example

As illustrated in the diagram, one among the possible applications concern the installation of a pole mounting TWP twilight switch in a highway lighting plant. When daylight dims below a set level (e.g. during twilight) the switch turns on the lighting devices, assuring the requested lighting. At dawn, when the light raise above the set threshold, the relays of TWP returns in open position.

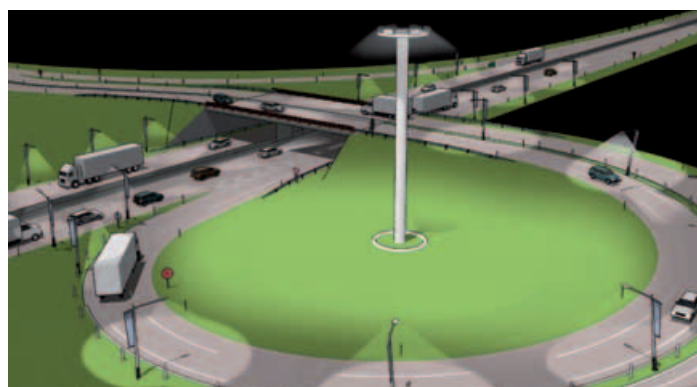
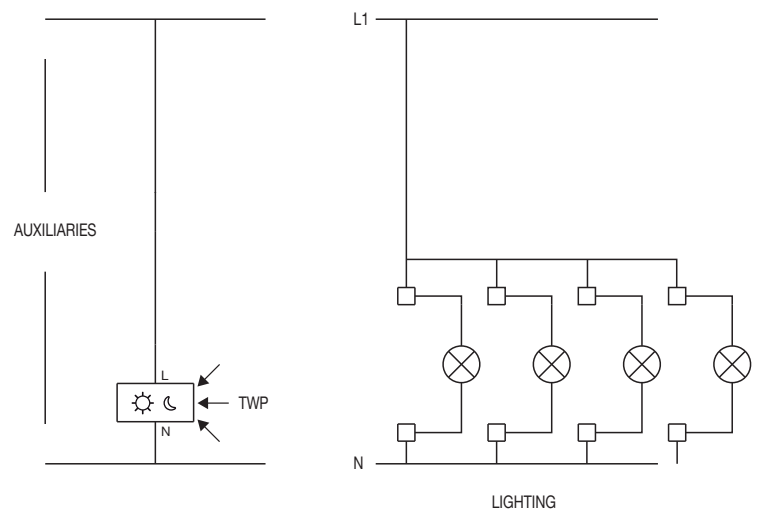
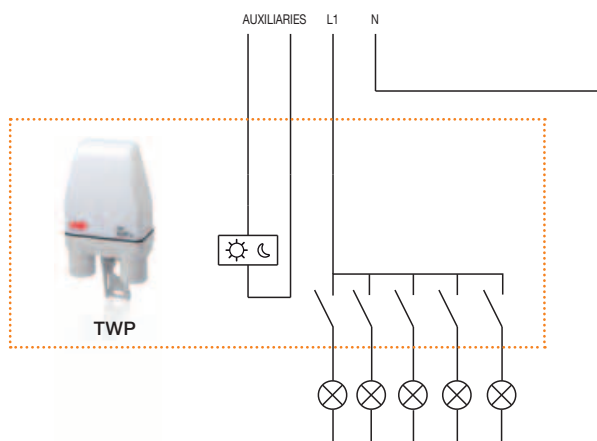

THS modular thermostats

THS series thermostats are able to control a wide range of refrigeration and heating applications.



The THS-C and THS-W models, both equipped with a potential-free switching contact, represent the optimum solution for regulating the temperature in heating systems and industrial applications and for controlling the temperature in refrigerated counters, greenhouses, dryers or tilting isothermal portals.

THS-1 and THS-4 sensors, which can be used in conjunction with the THS-C and THS-W thermostats, function within a -30 °C and +130 °C temperature range.

The THS-S model, with two potential-free independent contacts and equipped with a remote sensor included in the package, is indicated for controlling the temperature of switchboards, providing a cooling adjustment in the range +20°C to +60°C and anticondensation function in the range 0°C to +10°C.

Did you know that controlling the temperature in switchboards with the new THS-S thermostat is now simpler?

Unlike conventional models designed for installation on walls or panels, the THS-S modular thermostat is better able to control the temperature in switchboards since it is mounted on a DIN-rail, which needs no fastening accessories, and thanks to the capacity of the relay that allows it to control over 3 kW of heating elements without the use of external contactors.

THS modular thermostats

Range specifications

Ease of use

The possibility of setting one or two temperature setpoints on the front of the device and adjusting them without having to use any tools simplifies the configuration procedure. The instructions and diagrams are shown on the side of the product to ensure that the necessary information is always readily available when needed.

Visibility

Two indicator LEDs enable you to check the operation of the device at a glance: the yellow LED signals a sensor short-circuit and the green LED indicates the state of the contact.

Accuracy

The tiny temperature difference ensures the temperature set is maintained with great accuracy.

Safety

The lead-sealable and undetachable glass cover ensures maximum protection against tampering by unauthorized staff.

Compact size

Since it is so small in size, just two DIN modules, the THS thermostat can be used in a number of applications, even where space is a critical factor.

		THS-C	THS-W	THS-S
Rated voltage	V		230 AC	
Contact type		1 NO/NC		2 NO
Contact capacity				
Resistive loads	A		16	
Inductive loads	A		3	
Frequency	Hz		50-60	
Number of temperature setpoints		1 continuously adjustable		2 continuously adjustable
Adjustment range	°C	-20...+40	0...+60	0...+10/+20...+60
Max switching power	W		3500	
Differential	°C	1		2
Thermal gradient			1 °K/15 minutes	
Type of operation			ON/OFF fixed differential	
Max section of cables at terminals	mm ²		2,5	
Protection degree	IP		20	
Relay ON/OFF indication			LED indicator	
Temperature tolerance	°C		±1	
Operatin temperature	°C	0...+50		0...+ 70
Storage temperature	°C	-10...+65		-10...+70
Type of installation			DIN rail	
Case / colour			thermoplastic/grey RAL 7035	
Power consumption	VA		3	
Type of application			services-providing/industrial sector	
Programming			graduated scales with mechanical pointer	

THS modular thermostats

THS series thermostats are able to control a wide range of refrigeration and heating applications.

The THS-C and THS-W modular thermostats regulate the temperature differentially, as indicated in the figure below.

When the THS-C thermostat detects a temperature below the setpoint, it closes contact 1 until the temperature returns above the setpoint. It then reopens the contact and, when the temperature drops below the differential again, the cycle is repeated.

The THS-W thermostat works in the same way but the relay closes contact 5 when the temperature exceeds the maximum setpoint.

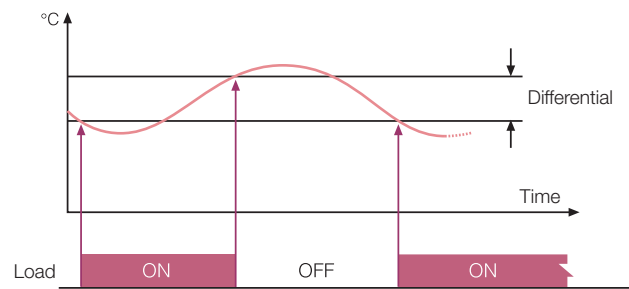
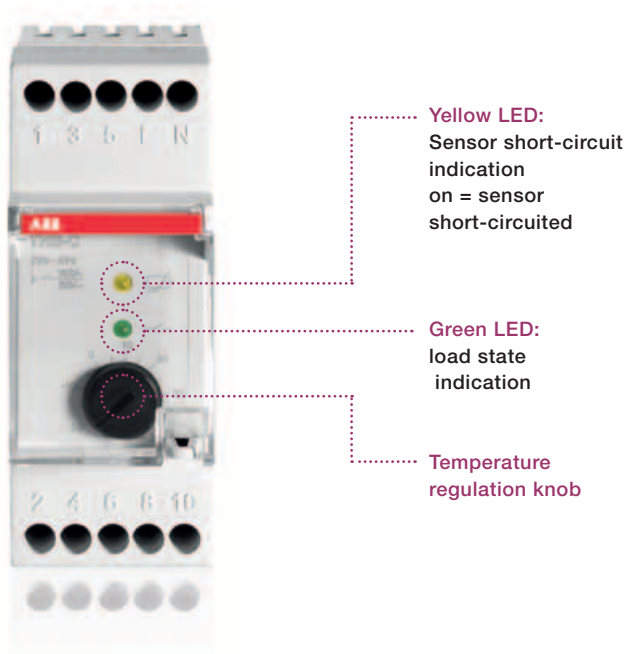

THS-C operating example

Sensor installation

The temperature sensor (supplied separately) is made of brass, encapsulated in silicone rubber, impermeable and resistant to high temperatures (130°C). It is 1.5 or 4 metres long and may be positioned at a distance of up to 100 metres.



THS modular thermostats

Operating principle

Modular thermometers let you control and keep a heating or cooling element at a set temperature, comparing the value read by the sensor with the one set by the user.

The THS range can thus guarantee switchboard operating reliability, perfect product conservation in refrigerated counters or cells, promote greenhouse production, optimise drying cycles, etc.

Application environments

THS thermostat installation is thus the best way to regulate temperature in automation and distribution switchboards, in heating systems, in industrial applications or to control refrigerator systems, greenhouses, dryers or isothermal folding portals.

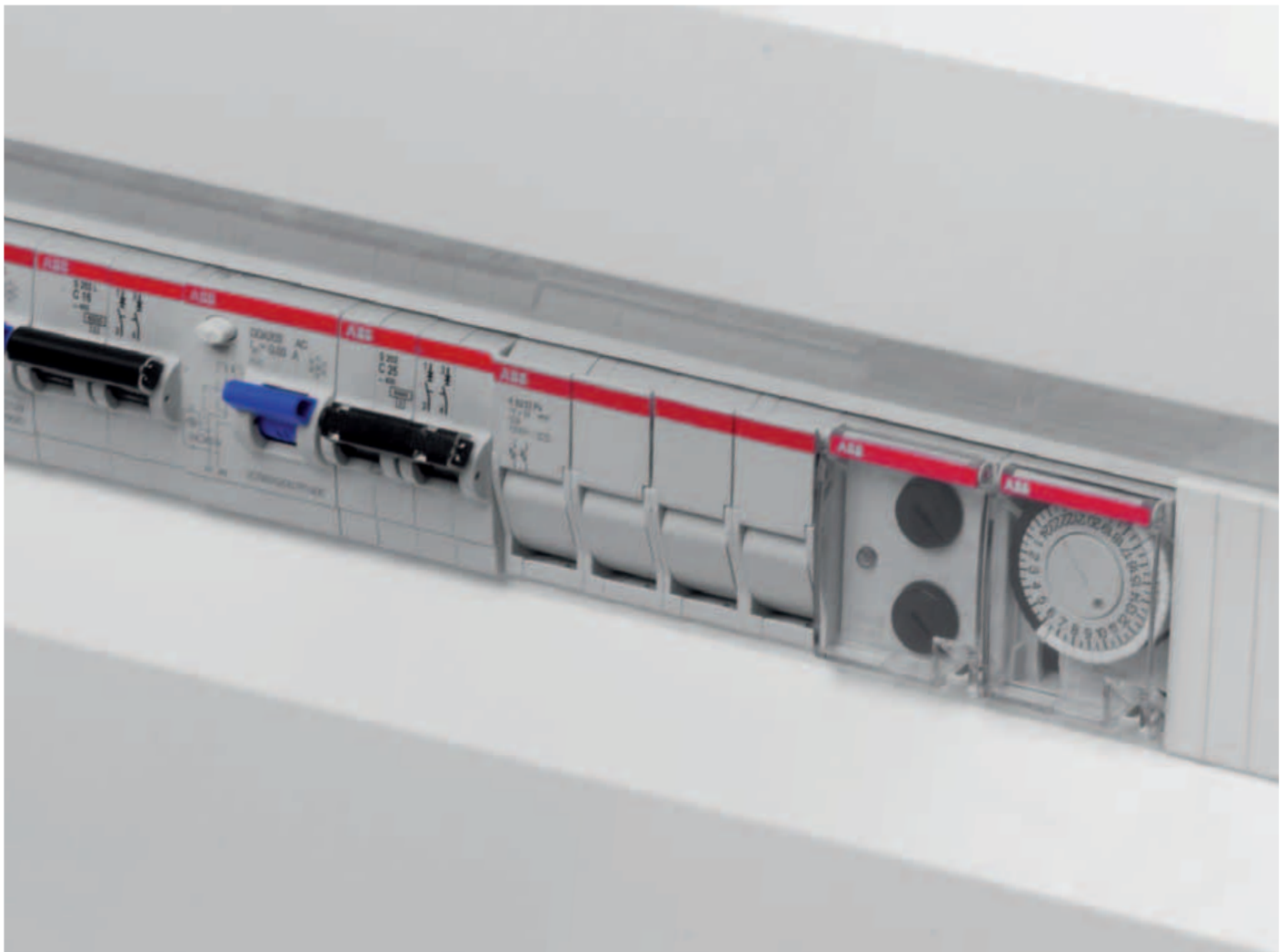

Installation example

As shown in the diagrams, one of the possible applications consists in the installation of a THS-S modular thermostat inside an automation or distribution switchboard where the temperature must be kept at a set value. Thanks to the THS-S thermostat, you can thus control the temperature, permitting cooling regulations between $+20 \div +60 \text{ }^\circ\text{C}$ and anti-condensation between $0 \div +10 \text{ }^\circ\text{C}$. Furthermore, you can manage up to 3kW of point heaters without having to use any external contactors to manage the load.

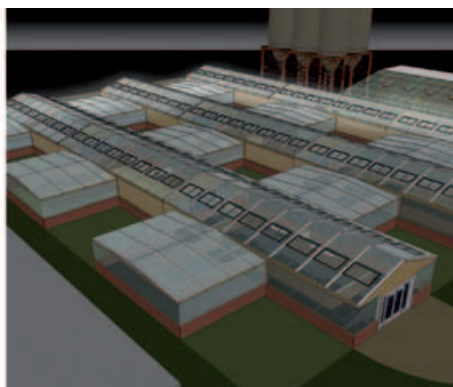
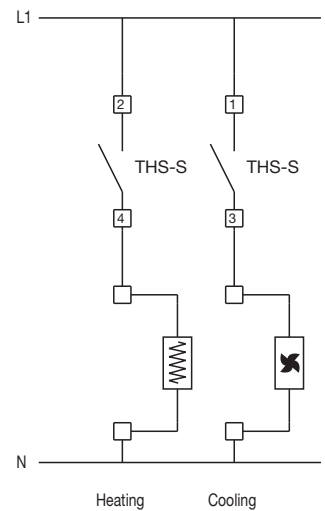
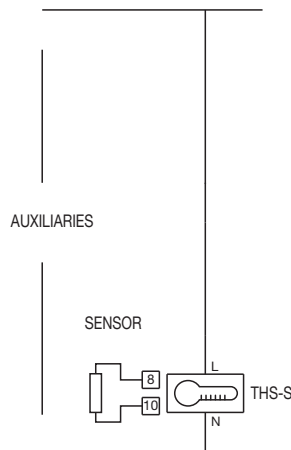
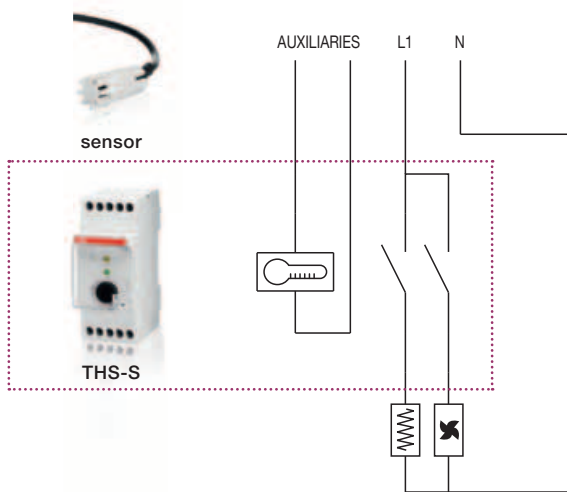

Guide to installation in residential buildings

Advanced technologies and performance: ABB's solutions integrate perfectly and provide a complete, functional and elegant system able to meet the requirements of every domestic and working environment.

- 1 - Outdoor lights in the garden
- 2 - Irrigation pumps for the garden
- 3 - Circulation pumps for swimming pools
- 4 - Staircase and garage lights
- 5 - Temperature and lighting control in greenhouses
- 6 - Skylights
- 7 - Temperature and lighting control in cellars
- 8 - Rolling shutter opening/closing
- 9 - Pumps for fountains and canals
- 10 - Temperature and lighting control in reptile vivariums and/or aquariums
- 11 - Turning convectors on/off
- 12 - Heating elements in the roof

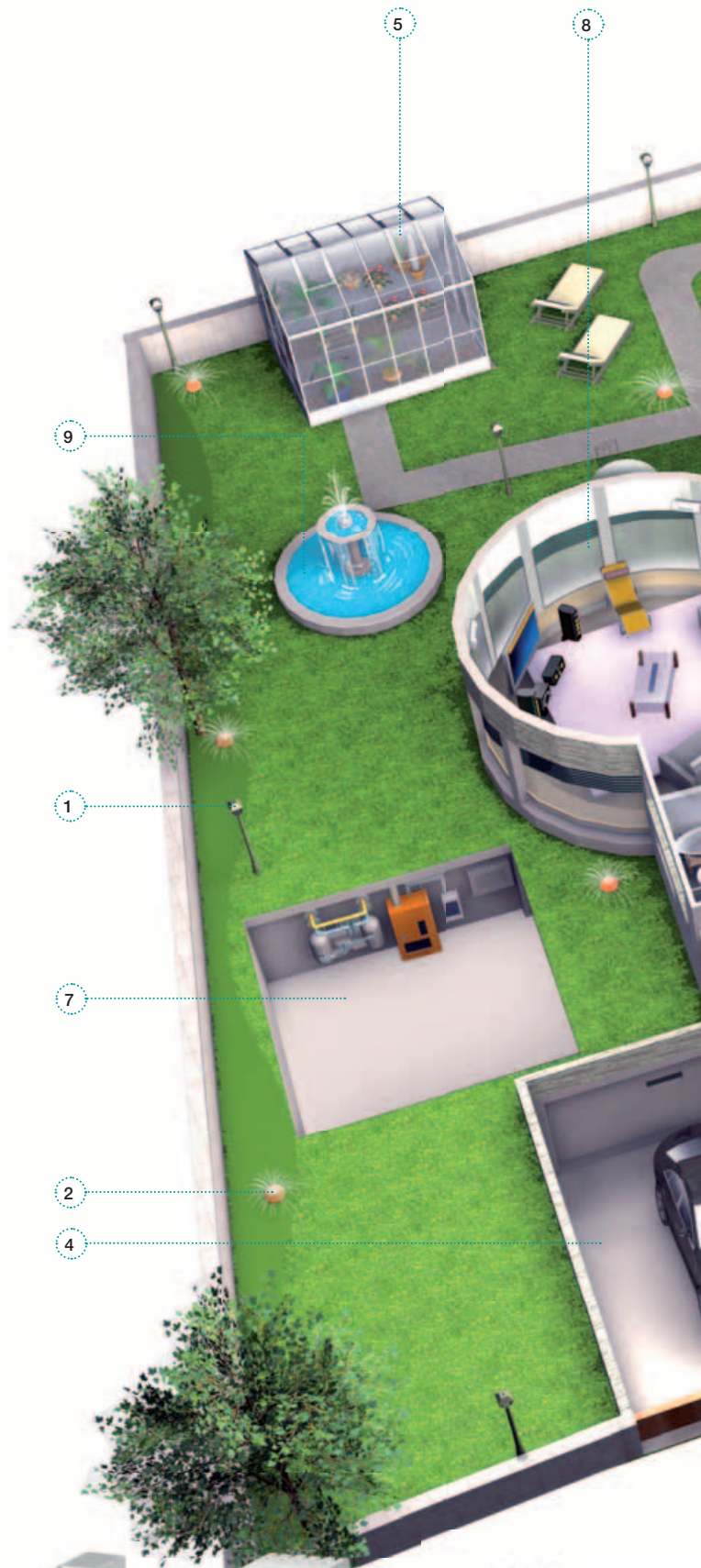

THS-W



AT3



AT2-R

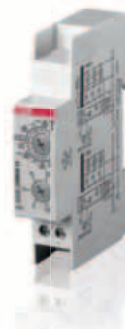

E 232-E230Multi 10



TW2/10K



TW1



3

12

6

11

10



D1



THS-S



E 232-230



AT1-R



THS-C

Guide to installation in residential buildings



1 - The outdoor garden lights are controlled by the **TW1** twilight switch, which turns them ON and OFF according to the preset level of luminosity.



2 - An **AT** electro-mechanical time switch controls the irrigation pumps in the garden by means of programmed time settings.

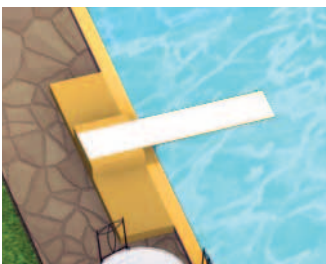

3 - The swimming pool water pump is regulated by digital time switch **D1**, which allows the various jets to be controlled separately.

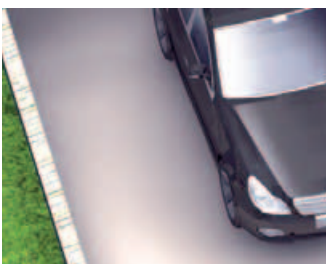

4 - **E 232-230Multi 10** turns on the staircase lights for the preset time and warns the user with a double flash before they go out.



5 - The heating function in greenhouses is regulated by model **THS-W**, installed in the switchboard along with an **AT** time switch, which controls the irrigation time and a **TW** twilight switch that automatically turns ON the lights.

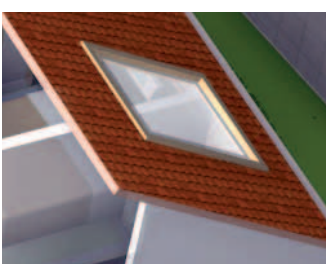

6 - The skylight can be opened and closed to suit requirements by digital time switch **D1**, or by the **TW2/10K** twilight switch for daytime applications.



7 - **E 232-230Multi 10** turns on the cellar lights when the button is pressed. The lights then remain ON until the button is pressed again. However, the lights will still be turned OFF after a preset time if the user forgets to press the button.



8 - Thanks to twilight switch **TW1**, the shutters at the windows of a house are controlled depending on the luminosity level outdoors.



9 - The pump that circulates the water is controlled by the **AT** electro-mechanical time switch according to the programmed setting.



10 - The temperature in the reptile vivarium or aquarium is regulated by the heating elements or fans controlled by the **THS** thermostat.



11 - The convectors are automatically regulated by the **AT** time switch according to the program selected.



12 - The roof temperature can be monitored instant by instant by means of the **THS**, so as to turn on the heating elements and prevent ice from forming.



Guide to installation in commercial buildings

Use of time switches, twilight switches, thermostats and staircase light switches achieves considerable energy savings in commercial applications. Lights and comfort functions will only be available when required in places open to the public and those reserved to personnel, thus avoiding waste and helping to protect the environment.

- 1 - Shop window lights
- 2 - Conditioning and lighting systems
- 3 - Main switchboard
- 4 - Lights in corridors, rooms
- 5 - Street lighting
- 6 - Lighting of monuments
- 7 - Church bells
- 8 - Lighting in amusement parks
- 9 - Lighting in parking lots
- 10 - Circulation pump of public fountains
- 11 - Advertising sign control
- 12 - Christmas lights



TWP



THS-S



TW1



TWA-1



AT2-R



D1



E 232-230



D2

Guide to installation in commercial buildings



1 - The lighting in shop windows is controlled by the **TW1** twilight switch which, in conjunction with one of the **AT** or **D Line** series of time switches, turns OFF the lights overnight to avoid wasting energy.



2 - The lighting and heating systems are controlled separately by means of a **D2** two-channel digital time switch.



3 - Distribution switchboard with cooling fan and heating elements controlled by model **THS-S**.



4 - The sensor in the corridor activates **E 232-230**, which keeps the lights in the rooms and corridors ON until the selected time terminates.



5 - Twilight switch **TWP**, which can be installed on a pole or wall, has a 10 lux presetting and allows the public street lighting to be controlled in a very simple way.



6 - The artistically arranged lighting for the buildings and monuments in cities is controlled by the **D Line** digital time switch, which provides a vast range of functions to suit the type of effect required.



7 - Thanks to the **D1** digital time switch, the bells of a church are controlled with one of the various different advanced functions allowing the user to regulate the intervals of time between one stroke and the next as required.



8 - The lights in an amusement park are controlled by the **TWA** astronomical twilight switch which, without an external sensor, allows them to function regularly without being affected by interference that could cause faults.



9 - The lights in a parking lot can be controlled according to the time of day or the level of luminosity outdoors, functions which are achieved with an **AT** electro-mechanical or **D Line** digital time switch, or by means of a **TW** twilight switch, respectively.



10 - The systems that pump the water in the fountains are controlled by the **D Line** digital time switch which, thanks to its advanced functions, creates plays of water like a sparkling waterfall or an elegant spray in a very simple way.



11 - Advertising signs run at preset times thanks to a weekly or annual program defined by a **D Line** or **DTS** series of digital time switches.

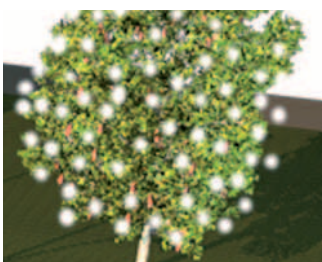

12 - In conjunction with the **D Line** digital time switch, the **TW1** twilight switch is able to control skylights automatically according to the level of outdoor luminosity, creating lighting effects thanks to the different functions provided by the **D Line** digital time switch itself.



Guide to installation in industrial buildings

Designed for ease of use, safety, comfort and energy savings, ABB's products optimize consumptions and increase the efficiency in industries by automating the use of pumps, valves, fans and motors with programs defined according to time, temperature or light intensity settings.

- 1 - Temperature control in switchboards
- 2 - Temperature control in floor heating coils
- 3 - Control of monitoring equipment
- 4 - Re-circulating and mixing pumps
- 5 - Food bins, galvanic tanks, etc.
- 6 - Motorized valve control
- 7 - Control of generic motors
- 8 - Air circulation fans for special areas
- 9 - Control of cold rooms
- 10 - Road safety barriers
- 11 - Control of electric fences
- 12 - Control of the lighting systems in tunnels



THS-S



THS-W



THS-C



AT3-R



TW2/10K



D2

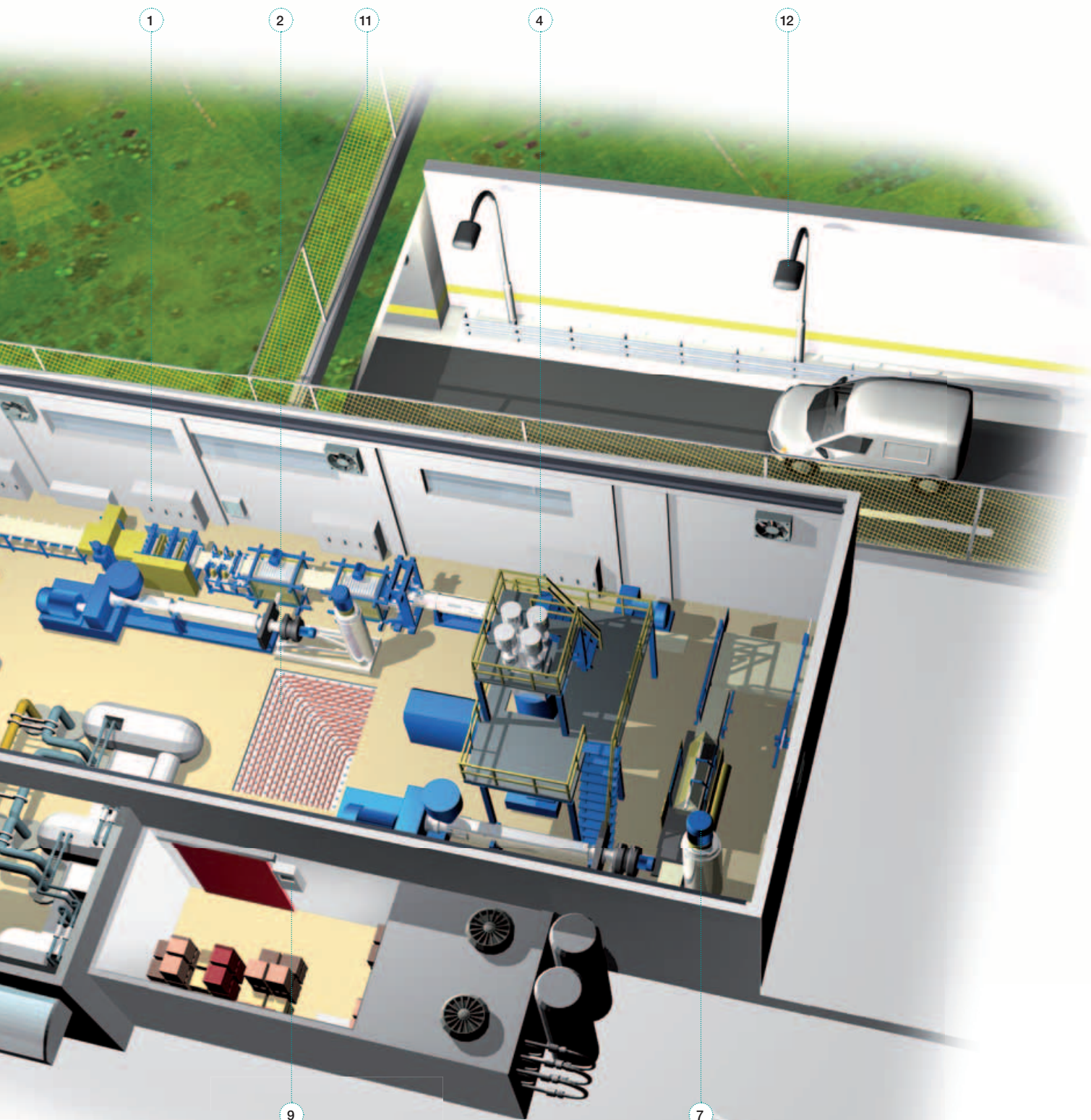

AT2-7R



D1

Guide to installation in industrial environments

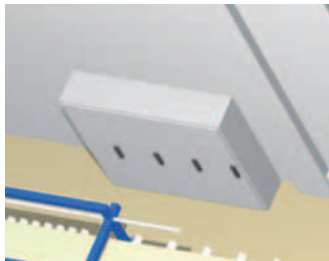

1 - The temperature in the switchboards is controlled by the **THS-S**, which maintains it at the selected setpoint.

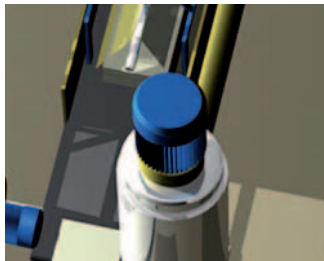

7 - Various different types of motors can be controlled by the **D Line** digital time switch, which cuts down on the energy wasted thanks to its advanced timing functions.

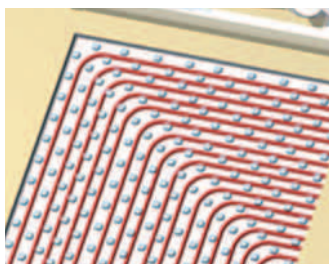

2 - The temperature of the coils is detected by the external sensor of the **THS** thermostat, which controls the temperature according to the preset value.



8 - Air circulation fans for special areas are automated by the **AT** weekly time switch as established by the program settings.

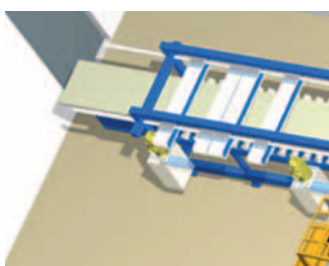

3 - The **AT** electro-mechanical or **D Line** digital time switch can control various different devices in simple operating systems that do not use a PLC.



9 - The **THS-C** model controls the cooling function in the cold room.



4 - Various pump models for re-circulation or mixing functions can be controlled by the **AT** series electro-mechanical time switches.

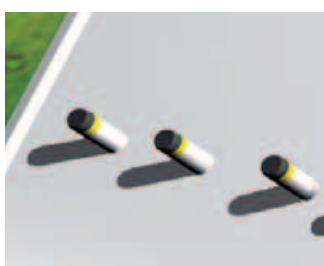

10 - Road safety barriers for access to unauthorized areas on certain days of the year for example, can be conveniently controlled by an hourly program in the **D Line** digital time switch.

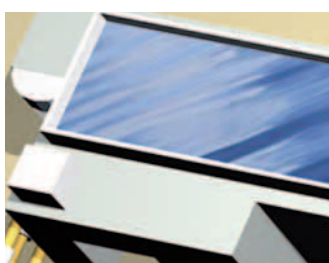

5 - The temperature in tanks, like the ones used for foodstuffs, is kept accurately at a setpoint by means of **THS** thermostats, thus ensuring high quality processing results.

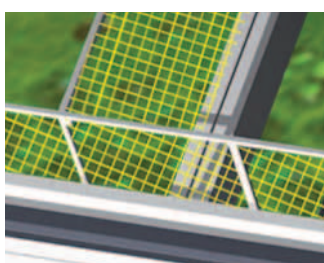

11 - To prevent unauthorized persons or animals from accessing areas during the night, the electric fence is controlled by the **D Line** digital time switch, which keeps it activated at preset times of the day.

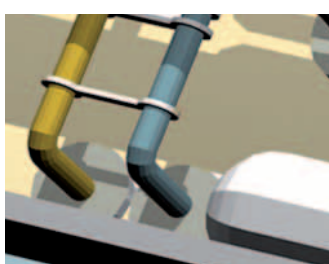

6 - Motor-operated valves are controlled according to the temperature detected by the **THS** thermostat, which achieves higher thermal precision thanks to the low differential.



12 - The lighting systems in tunnels are controlled by the **TW2/10K** so as to guarantee the correct degree of visual perception inside and of the indications in the lighting systems in the external areas just outside the tunnels.



Guide to installation in the agrifood sector

This application example highlights the versatile features of the THS range, which is able to create the ideal environment in every situation by adjusting the temperature in the switchboards and ensuring reliable operation: in cold rooms and refrigerated counters so as to perfectly preserve the foodstuffs, in greenhouses to encourage plant growth and in dryers to optimize the processing cycles.

- 1 - Temperature control in distribution switchboards
- 2 - Refrigeration control in cold rooms
- 3 - Temperature control in greenhouses
- 4 - Temperature control of dryers

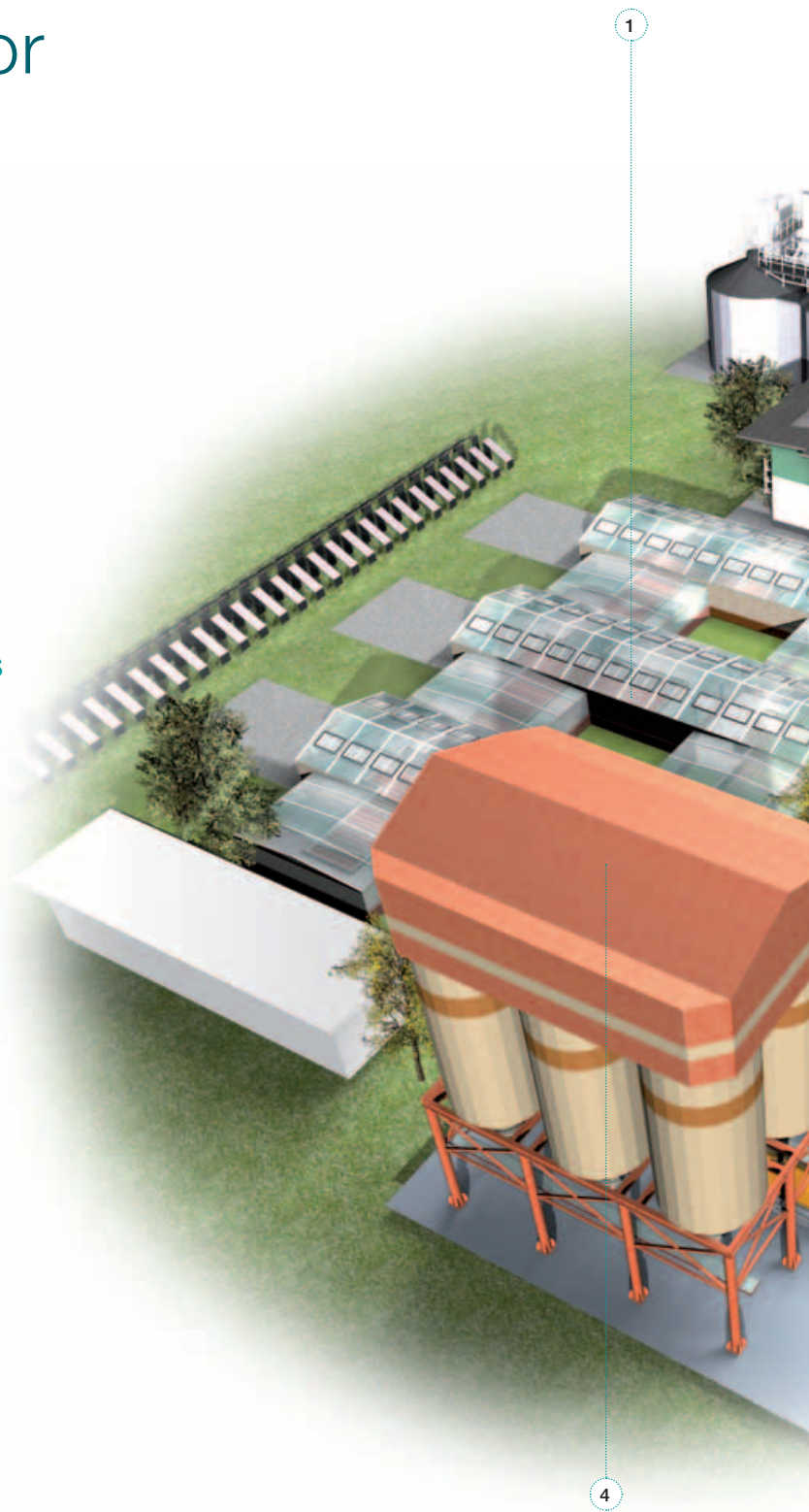

THS-S



THS-W



THS-C



AT3-R



TW2/10K



D2

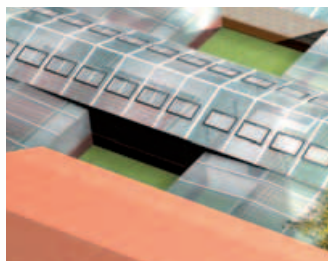

1 - Distribution switchboard with cooling fan and heating elements controlled by model **THS-S**.



2 - The **THS-C** model controls the cooling function in the cold room.

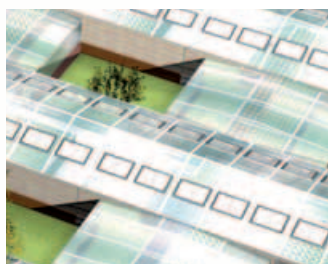

3 - The heating function in greenhouses is regulated by model **THS-W**, installed in the switchboard along with an **AT** time switch, which controls the irrigation time and a **TW** twilight switch that automatically turns on the lights.



4 - The correct temperature in the dryer is guaranteed by model **THS-W**.



AT2-7R



D1

Order codes

AT analog time switches

Contact	Version	Description Type	ABB code	Bbn 8012542 EAN	Piece weight kg	Number of modules	Pack.
1 NO	Daily	AT1	2CSM204205R0601	042051	0.095	1	1
1 NO	Daily with running reserve	AT1-R	2CSM204215R0601	042150	0.095	1	1
1 NO/1 NC	Daily	AT2	2CSM204105R0601	041054	0.118	2	1
1 NO/1 NC	Daily with running reserve	AT2-R	2CSM204115R0601	041153	0.118	2	1
1 NO/1 NC	Weekly with running reserve	AT2-7R	2CSM204125R0601	041252	0.118	2	1
1 NO/1 NC	Daily	AT3	2CSM204225R0601	042259	0.18	3	1
1 NO/1 NC	Daily with running reserve	AT3-R	2CSM204235R0601	042358	0.18	3	1
1 NO/1 NC	Weekly with running reserve	AT3-7R	2CSM204245R0601	042457	0.18	3	1

D and DTS digital time switches

Contact	Version	Description Type	ABB code	Bbn 8012542 EAN	Piece weight kg	Number of modules	Pack.
1 NC/NO	1 channel	D1	2CSM258763R0621	587637	0.140	2	1
1 NC/NO	1 channel with key	D1 PLUS	2CSM257583R0621	575832	0.140	2	1
1 NC/NO	1 channel with key, synchronizable	D1 SYNCHRO	2CSM257493R0621	574934	0.140	2	1
2 NC/NO	2 channels	D2	2CSM256313R0621	563136	0.140	2	1
2 NC/NO	2 channels with key	D2 PLUS	2CSM277583R0621	775836	0.140	2	1
2 NC/NO	2 channels with key, synchronizable	D2 SYNCHRO	2CSM277363R0621	773634	0.140	2	1
-	Programming key	D KEY	2CSM277143R0621	771432	0.002	-	1
-	Programming software for D line	D SW	2CSM299973R0621	999737	0.005	-	1
-	DCF77 antenna for D line	D DCF77	2CSM299983R0621	999836	0.150	-	1
-	GPS antenna for D line	D GPS	2CSM299993R0621	999935	0.150	-	1
3 NO/NC	3 channels with key, synchronizable	DTS/3Y	2CSM133100R0601	507000	0.380	6	1
4 NO/NC	4 channels with key, synchronizable	DTS/4Y	2CSM134100R0601	538509	0.410	6	1
-	DCF77 antenna for DTS	DTS/DCF	2CSM000010R0601	538608	0.230	-	1
-	Programming software for DTS	DTS/PRG-SW	2CSM000050R0601	538707	0.350	-	1

E 232 staircase lighting switch

Time settings	Version	Description-Type	ABB code	Bbn 4016779 EAN	Piece weight kg	Number of modules	Pack.
1...7 min	Electro-mechanical staircase light switch	E 232-230V	2CDE110000R0501	548243	0.081	1	10
0,5...20 min	Electronic staircase light switch	E 232E-230N	2CDE110003R0511	654166	0.083	1	10
0,5...20 min	Multivoltage electr. staircase light switch	E 232E-8/230N	2CDE010003R0511	654173	0.092	1	10
0,5...20 min	Multifunction electr. staircase light switch	E 232E-230Multi 10	2CDE110013R0511	654180	0.082	1	10
0,5...20 min	Multifunction multivoltage electr. staircase light switch	E 232E-8/230Multi 10	2CDE010013R0511	654197	0.093	1	10
20...60 sec	Switch-off warning device	E 232-HLM	2CDE150000R0521	548281	0.075	1	10

TW twilight switches

Contact	Version	Description Type	ABB code	Bbn 8012542 EAN	Piece weight kg	Number of modules	Pack.
1 NO	Daily	TW1	2CSM204135R1341	041351	0.107	1	1
1 NO	Daily with running reserve	TW2/10K	2CSM204145R1341	041450	0.215	2	1
1 NO/1 NC	Daily with running reserve	TWP	2CSM204165R1341	041658	0.155	-	1
1 NO/1 NC	Weekly with running reserve	LS-65	2CSM204185R1341	041856	0.085	-	1
1 NO/1 NC	Daily	LS-SP	2CSM204195R1341	041955	0.035	-	1
1 NO/1 NC	Daily with running reserve	TWA-1	2CSM204365R1341	043652	0.16	2	1
1 NO/1 NC	Weekly with running reserve	TWA-2	2CSM204375R1341	043751	0.16	2	1

THS modular thermostats

Contact	Version	Description Type	ABB code	Bbn 8012542 EAN	Piece weight kg	Number of modules	Pack.
1 NO/NC	Modular thermostat 0...+60 °C	THS-W	2CSM207083R1380	070832	0.180	2	1
1 NO/NC	Modular thermostat -20...+40 °C	THS-C	2CSM251163R1380	511632	0.180	2	1
2 NO	Modular thermostat for switchboards	THS-S	2CSM236803R1380	368038	0.200	2	1
-	Temperature detecting sensor, 1.5 m	THS-1	2CSM202033R1380	020332	0.0035	-	1
-	Temperature detecting sensor, 4m	THS-4	2CSM277603R1380	776031	0.0035	-	1

Wiring diagrams

AT analog time switches

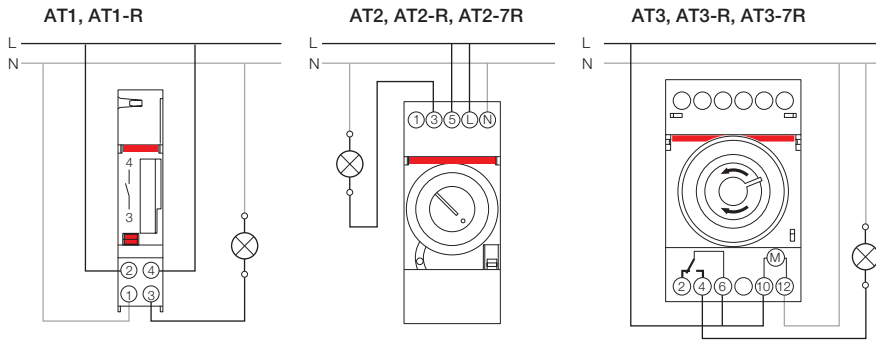

D digital time switches

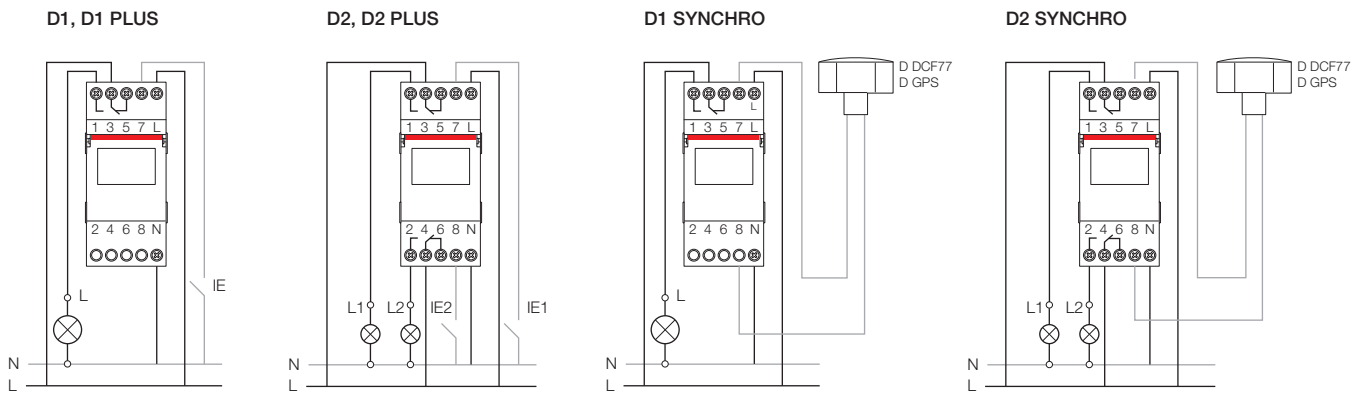

TW twilight switches

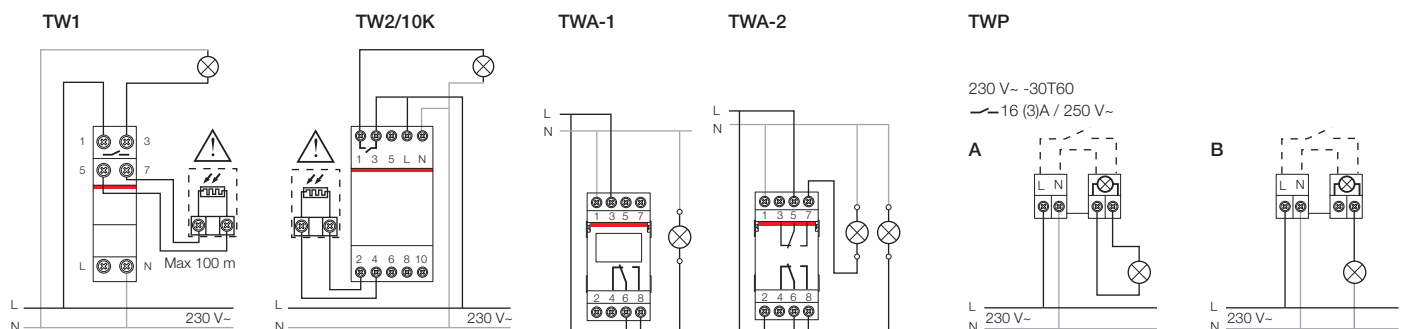

E 232 staircase lighting switches

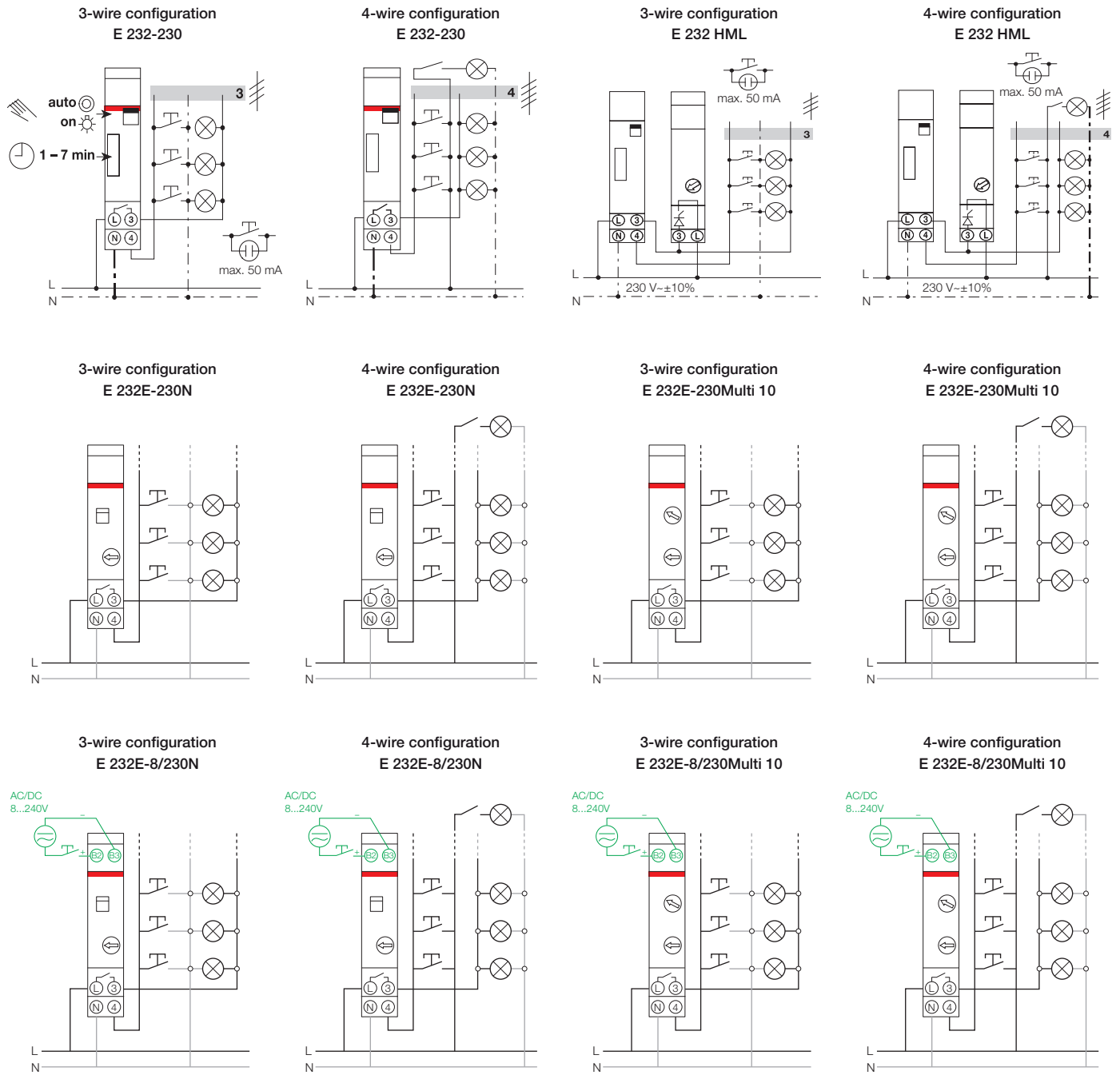

THS modular thermostats

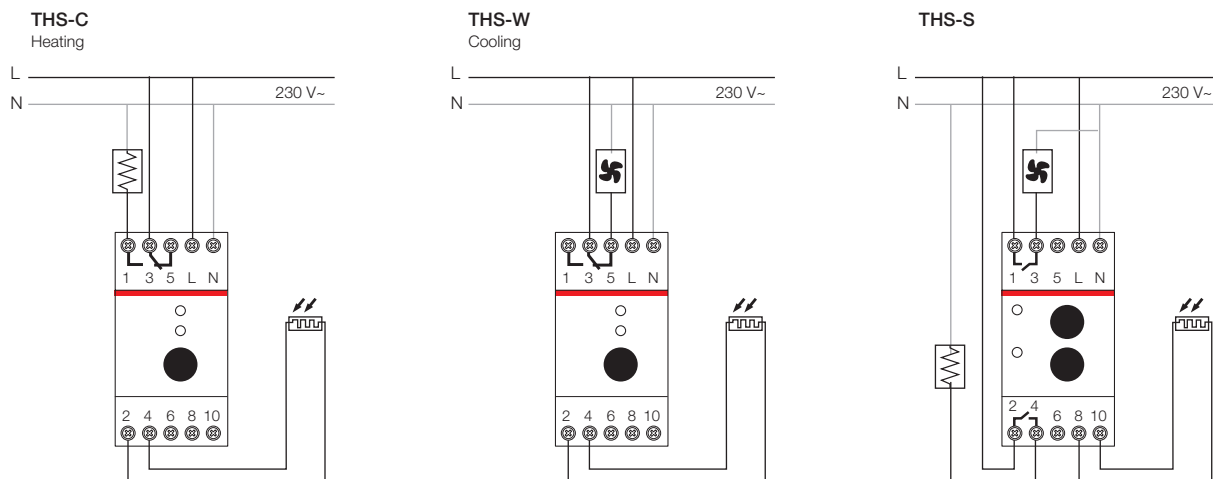

Overall dimensions

AT analog time switches

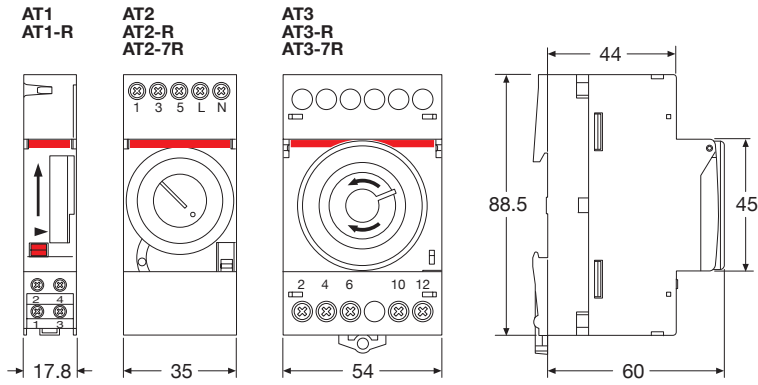

D and DTS digital time switches

D1, D1 PLUS, D2, D2 PLUS
D1 SYNCHRO, D2 SYNCHRO

DTS7/3Y - DTS7/4Y

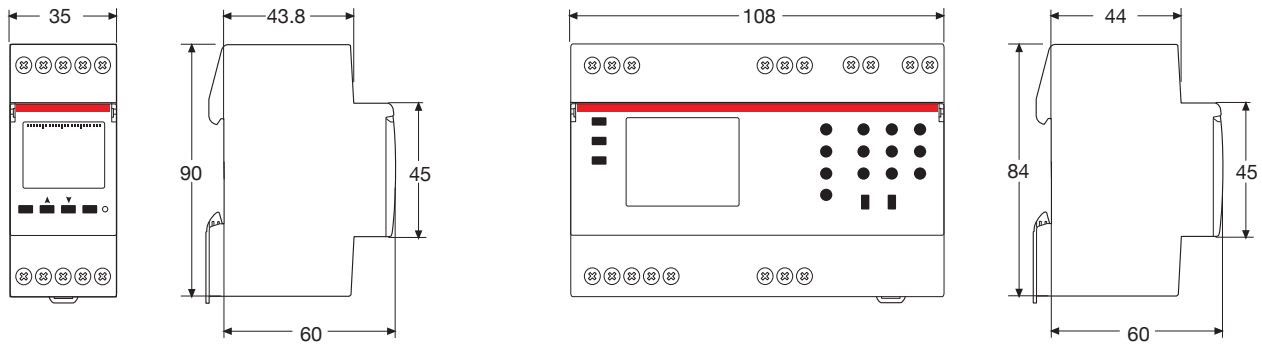

E 232 staircase lighting switches

E 232-HLM

E 232-230

E 232E-230N
E 232E-8/230N

E 232E-230Multi 10
E 232E-8/230Multi 10

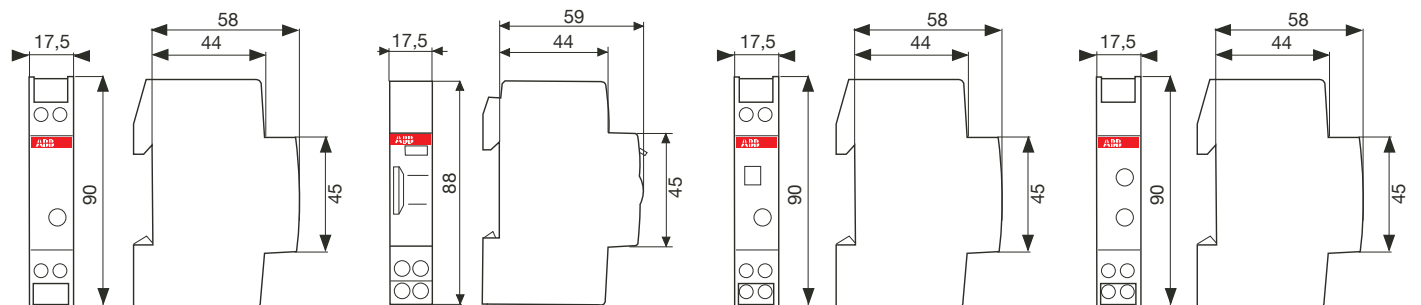

TW twilight switches

TW1

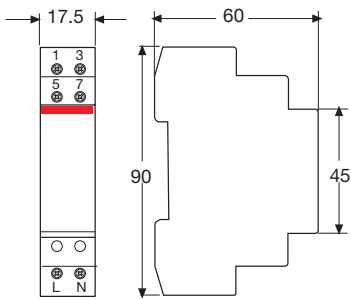

TWA-1, TWA-2

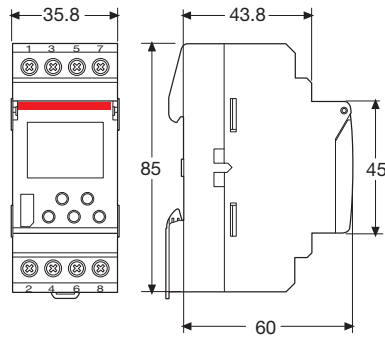

TW2/10K

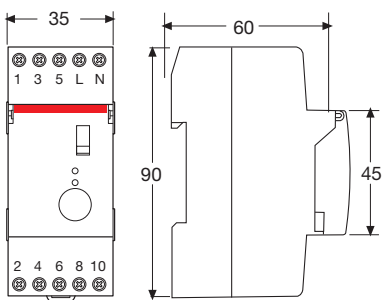

LS-SP

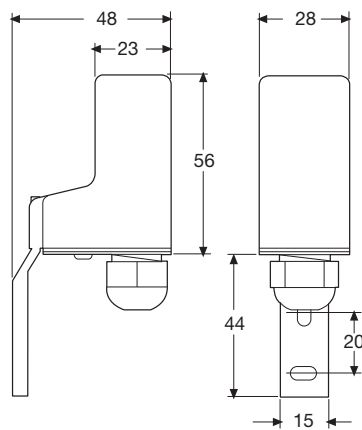

THS modular thermostats

THS-C

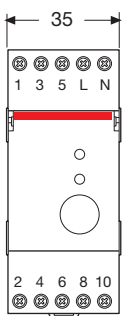

THS-W

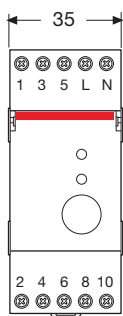

THS-S

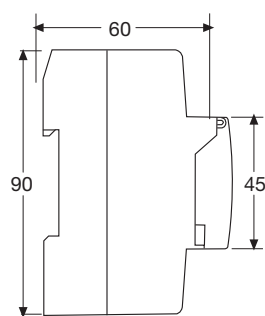
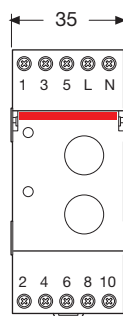

Frequent queries and problem-solving

When is it better to use a digital time switch rather than an electro-mechanical one?

Digital time switches are more accurate, take less time to switch and have many more programming functions (impulsive, cyclic, random, vacation modes, etc.) than analog time switches. Moreover, they have a longer-lasting running reserve (years instead of hours) since they have no moving mechanical parts. Whatever the application, when there are numerous, frequent and different operations (daily, weekly or annual), the D or DTS series time switches provide a better performance with only a little difference in price.

The permanent OFF position is not available in the 1-channel model. How can it be obtained?

The permanent OFF position is used for servicing work or holiday periods. In both cases, the load can be disconnected permanently by merely disconnecting the protection on the supply side.

Can more than one sensor be connected with models TW1 and TW2/10K?

No, one sensor must always be used for each device.

Can different types of sensors be connected with models TW1 and TW2/10K?

No, the only sensor allowed is the LS-SP type.

When must an astronomical time switch be used?

When the length of the connection between the device and sensor exceeds 100 m, or when the connection is too complicated (e.g., switchboard installed in a cellar).
When the sensor cannot be installed away from light sources (amusement parks, camp sites, etc.).
When external agents prevent the sensor from functioning correctly, e.g. pollution or vandalism.

Glossary

analog: electro-mechanical time switch programmed by moving the positions of the metal tabs and synchronized with a quartz battery or via the network frequency.

digital: electronic time switch equipped with an LCD display and sometimes with a programming key so that programs can be exchanged.

daily time setting: 24-hour periodic programming.

hourly time setting: 1-hour periodic programming.

weekly time setting: 7-day periodic programming.

yearly time setting: 1-year periodic programming.

running reserve: interval of time during which a switch may function normally without network supply voltage thanks to an internal backup battery.

minimum switching time: the shortest time between an ON-OFF cycle.

metal tabs: small sliding metal segments, generally arranged in a circle on the frontal dial of an electro-mechanical time switch. Their width represents the minimum switching time.

impulsive programming: programming function with an extremely short load switching time.

cyclic program: programming function for periodically switching the load.

lux: this is the International System's unit of measurement for illumination (lx symbol).

DCF77: the official German time signal permanently transmitted from Mainflingen, Germany (50° 01' N, 09° 00' E) with 50 kW power. The emitter's reception range is around 2,500 km with a precision of 1 second every 300,000 years.

GPS: the Global Positioning System (GPS) is a satellite positioning system with continuous, worldwide coverage. It is controlled by the US Department of Defense. The GPS system combines the time supplied by various atomic clocks installed on board its satellites, while a network of terrestrial stations determines and corrects the errors. Since the time is obtained from several different sources at the same time, the clock can automatically compensate for propagation delays and other problems, thus achieving a precision of less than one second.

Astronomical time switch: twilight or digital time switch able to forecast the exact time the sun rises and sets according to the date and latitude in which it is installed, without requiring an external light sensor.

switching delay: switching delay of a twilight switch. It prevents untimely switching due to rapid changes in the degree of light caused by external factors (e.g. the headlights of a vehicle or the shadow cast by a cloud).

hysteresis: interval between light intensity values that cause the ON-OFF switch to function: it prevents switching oscillations at dawn and dusk.

EEPROM memory: programmable, non-volatile electronic memory device that keeps store and safe the time and date settings even during a power failure.

network frequency synchronizing: synchronizing system of an electro-mechanical time switch by means of the network frequency, usually ensured by a contract with a Public Utility Company.

Contact us

ABB SACE

A division of ABB S.p.A.

Via L. Lama, 33

20099 Sesto S. Giovanni (MI) - Italy

Tel.: +39 02 24141

Fax: +39 02 24143892

www.abb.com

The data and illustrations are not binding. We reserve the right to modify the contents of this document on the basis of technical development of the products, without prior notice.

Copyright 2011 ABB. All right reserved.

2CSC440020B0201 - 12/2011 - 100 Pz.