

Differential Pressure & Flow

For our complete online catalog visit our website:

www.orangeresearch.com

DIFFERENTIAL PRESSURE

- Gauges • Switches • Transmitters



- Filtration
- Level
- Flow

LIQUID & GAS FLOW

- Meters • Switches • Transmitters



- Heat Exchangers
- Chillers
- Coolers

Service

We understand that people make the difference. At our location in Milford, Connecticut, we have highly trained and experienced staff ready to help you. Product selection and applications assistance are only a call away while detailed information is available on our website. With a commitment to meeting the needs of customers, we dedicate ourselves to fast, quality service and reliable information.

Worldwide, our distributors complement this effort, combining local expertise with the same reliable service. Most of our distributors have been with Orange Research for more than 25 years!



Design

Our engineering staff is committed to state-of-the-art engineering, design and testing of all standard, new, modified or OEM products. We concentrate on fulfilling customer requirements with a broad range of standard products and many innovative custom designs. What you see in this catalog is only a part of our offering. Contact us with your ideas, we'll design a solution.



Manufacturing

Our manufacturing capabilities include everything from CNC machining centers to efficient assembly and accurate calibration standards. Our facilities reflect our commitment to technology investment. A dedication to Continuous Improvement allows for flexible and accurate scheduling and superior quality assurance, whether we're manufacturing a configured model or shipping from stock. This positions us to meet your Kanban, JIT or rush requirements for large or small quantities. Our popular models can ship in less than one week — *Same Day Delivery is common!*



DIFFERENTIAL PRESSURE

Introduction

Basic Applications	2
Three Basic Components.....	2
How They Work.....	3
The Orange Advantage in Differential Pressure	3
Mounting Methods	4
Optional Features	5
Common Differential Pressure Ranges	5

Differential Pressure Instruments

1200 & 1300 Series Piston Sensor for Liquids Range: 0-5 to 0-1000 psid	6
1500 & 1800 Series Diaphragm Sensor for Liquids and Gases Range: 0-5" H ₂ O to 50 psid	8
1502 & 1533 Series Heavy-duty Diaphragm sensor for High DP Liquids or Gases Range: 0-5 to 300 psid	10
Piston or Diaphragm Sensors with Explosion-Proof Enclosures Range: 0-5" H ₂ O to 0-300 psid	12
1002 & 1020 Mini DP Piston & Diaphragm Sensors for Liquids and Gases Range: 0-25" H ₂ O to 0-100 psid	14

Switches, Relays & Transmitters

Differential Pressure Electrical Details	26
--	----

LIQUID & GAS FLOWMETERS

Introduction

In-line Flowmeters.....	16
Applications	16
Three Basic Components.....	16
How They Work.....	17
The Orange Advantage in Flow	17
Standard Flow Ranges	18
Calibration	18
Options	19
Density Correction Factors — Air & Gas Flow	19

Flow Instruments

2020 Series Fixed-Orifice Flow for Low Flow Rates — Liquid or Gas	20
Range 0-2 to 0-40 GPH (liquid), 1.5-5 SCFM (gas)	
2200, 2300 & 2400 Series Variable-Area Flow for Liquid and Gas Range 0-1 to 0-30 GPM (liquid), 1.5-10 to 1-100 SCFM (gas).....	22

Fixed Set-Point Flow Switches

Piston Sensors for Liquids Range 0.1 to 1.5 GPM	24
--	----

Switches, Relays & Transmitters

Flow Electrical Details	26
-------------------------------	----

Basic Applications

Applications assistance for these and many other uses for differential pressure gauges is readily available from Orange Research.

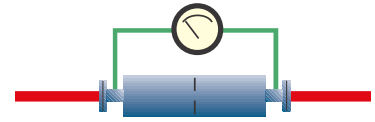
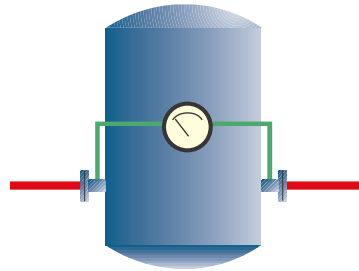

Filters/Strainers

Pressure drop across filter or strainer informs operator when it's time to replace, backwash or bypass filter elements. Prevents servicing too late or too early. Clean & dirty scales are popular. Can be used to automatically initiate cleaning at specific setpoint.

Flow Rate Indication

Flow Scale based on differential pressure is popular on venturi, orifice plates or other primary flow elements. Inexpensive and accurate alternative for large and small pipes. Specify differential pressure the flow rate is based on when ordering.

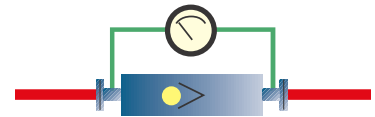
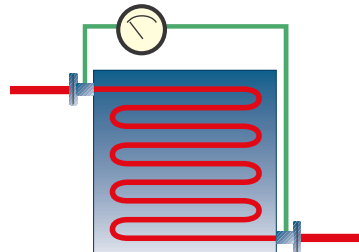
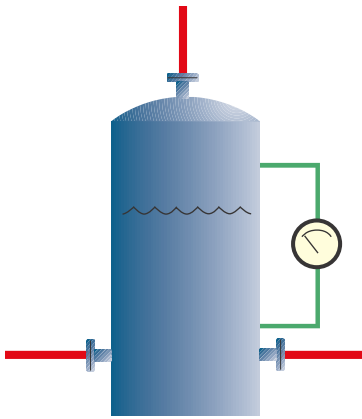

Liquid Level

Pressure differential between bottom and top of tank allows for level readings on pressurized tanks. Popular in cryogenics. Scales can read in percentage filled or height of fluid. Specify specific gravity of fluid and height of tank when ordering.

Heat Exchangers

Pressure drop across heat exchangers indicates problem conditions such as scale or debris buildup. Improve efficiency by alerting operator of problem conditions so that proper temperature and flow rate can be maintained.

Backflow Prevention

Used in backflow prevention test kits, our gauges are popular for testing backflow prevention valve operation. Pressure drop is an indication of valve performance. Regular maintenance of these valves ensures the safety of public water supply.

Three Basic Components

Select with all three components or:

- Drop the dial case for a switch model
- Drop the switch for a gauge model

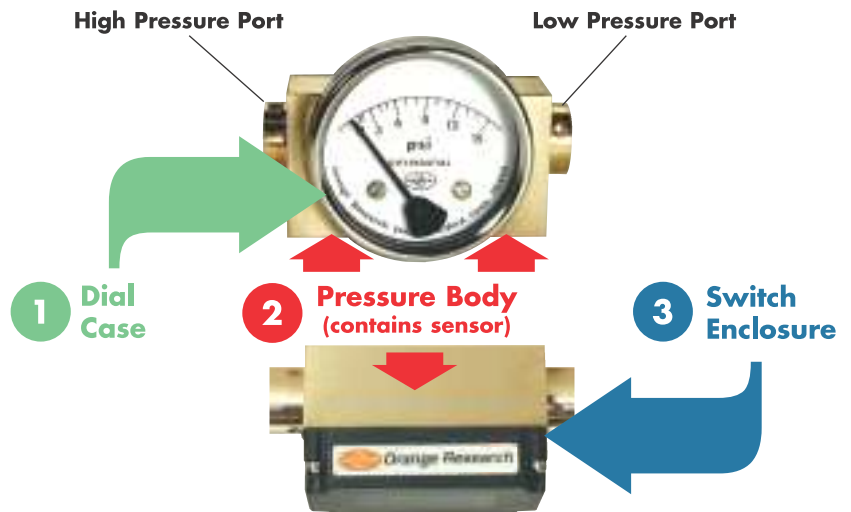

How They Work

Below, a 15 psi differential in pressure results in movement of the spring-loaded sensor (piston or diaphragm) from the high pressure port to the lower pressure port, from left to right. The sensor magnet

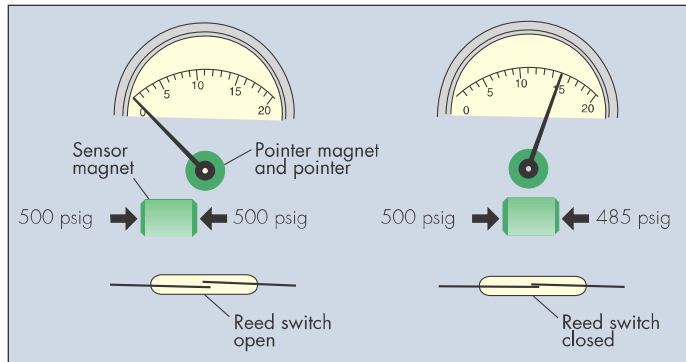

Piston sensor DP

Piston or Diaphragm Sensor?

Our piston sensor models are primarily designed for liquid applications. They exhibit a slight amount of bypass as the fluid migrates from the high to the low pressure port. For gas applications the migration is greater. We incorporate a flexible Teflon seal in our sensor, which keeps the bypass very low.

movement induces a rotation in the pointer magnet and the attached pointer. The pointer reflects the 15 psi differential on the dial scale. A reed switch actuates as the sensor magnet moves into close proximity.

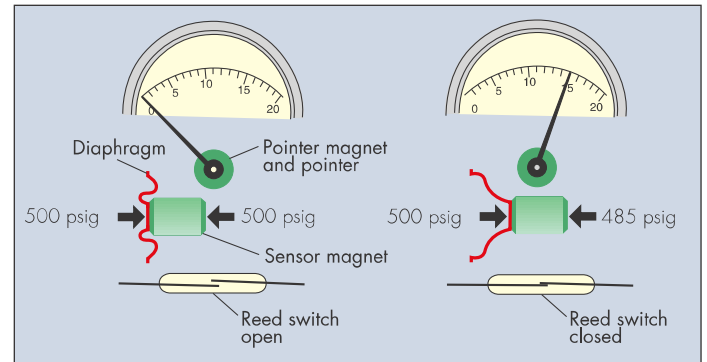

Diaphragm sensor DP

In our diaphragm sensor models the high and low-pressure ports are completely isolated from each other. There is no bypass and therefore they are appropriate for air or gas along with liquids. They also come in a variety of sizes allowing for very sensitive measurements. Consider some of our diaphragm models for the addition of a diaphragm seal.

The Orange Advantage in Differential Pressure

Low cost

Compare our low cost pressure gauges to the dual bourdon tube or bellows type and you will find we may have 2% accuracy where others may have 1% or better, but you may find savings up to \$1,000 per gauge! Orange Research uses a lower cost, simple, rugged design to achieve similar, or better, results compared to the more expensive units.

Rugged design – to 10,000 psi

Our pressure bodies are machined from solid blocks of metal, some handling up to 10,000 psi line pressures. Our dial cases are weatherproof and withstand the harshest environments. Built to last, our gauges are known for long life. Many have been in the field for over twenty years.

Our differential pressure sensors, either piston or diaphragm type, are designed to handle pressure spikes with no damage or degradation of accuracy. These sensors are completely separated from the indicator and the electronics so there is no need for solid front dials or blowout ports as required on competitor's designs.

Large selection

The number of models and standard features demonstrates the variety of our DP line. Choose from special dial features, hazardous location models, many process connections and mounting configurations. Many types of switches, relays or transmitter outputs are available. We also welcome specials in the quantity of one.

Mounting Methods

- **PROCESS LINE MOUNTING:** Most popular method – select Basic dial case – process line connections support gauge and no other mounting required.
- **PANEL MOUNTING:** Select Flanged dial case (includes 2 or 3 mounting holes) or select Basic dial case with c-clamp option.

- **PIPE MOUNTING:** Select Basic dial case with optional u-bolt bracket to mate gauge to pipe.
- **WALL MOUNTING:** Select Basic dial case with optional straight or right angle bracket to mate gauge to wall or other flat surface.

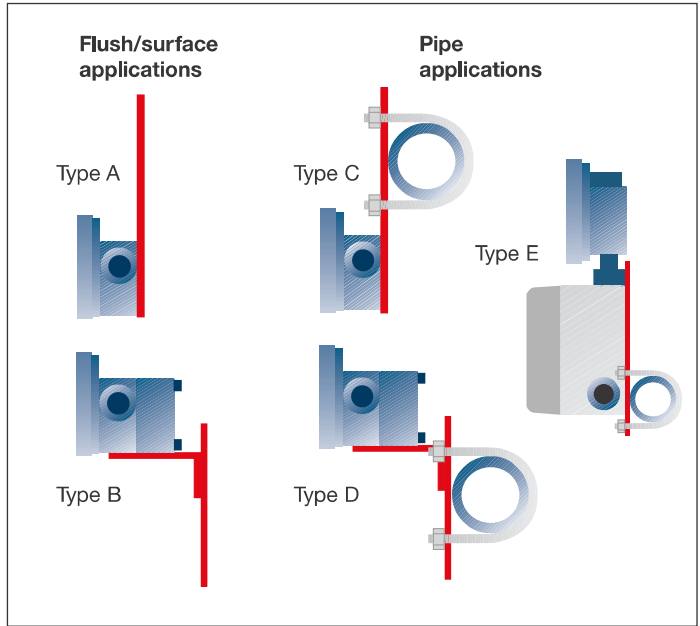

Two Dial Case Styles

B “BASIC”: This case is the most popular choice since the gauge is often supported by the process line. An optional c-clamp is offered for panel mounting.

F “FLANGED”: This case has holes for panel mounting. Two or three holes are drilled in the flange to accept screws for flush mounting to the panel.

DIAL CASE MATERIALS (these materials represent dial case only, not the pressure body):

- 2.5” Dials: stainless steel
- 3.5”, 4.5” & 6” Dials: cast and machined aluminum with a durable, black painted finish

WEATHERPROOF: All of our dial cases are weatherproof. This feature also facilitates liquid filling, which is an option available on all standard gauges.

Optional Mounting Brackets

A variety of brackets are available for mounting instruments on walls, panels and pipes. Pipe clamps mount units to various size rods or pipes.

Description	Suitable for Model Number
Flush/surface mounting brackets	
Type A	1201, 1502, 1516
Type B	1203, 1303, 1533, 1800 series
Pipe mounting brackets	
Type C	1201, 1502, 1516
Type D	1203, 1303, 1533, 1800 series
Type E	For hazardous location models 1204, 1504, 1514, 1804

Optional Features



- Dual Scale**
- Combine two equivalent scales
 - Internationally understood



- High Temperature**
- Handle hostile conditions
 - Up to 450°F – model & material dependent



- Follower Pointer**
- Indicate worst condition
 - Track off-hours problems
 - Trace filter blowout
 - Great for field use



- Liquid Level Scale**
- Measure level in tanks
 - No sensor in fluid
 - Great for cryogenics
 - Specify S.G. & tank height



- Red or Multicolor Arc**
- Easy-to-read
 - Eliminate errors
 - Recognize alarm conditions



- Square Root Scale - Flow**
- Use w/venturi & orifice plates
 - Cheaper than large flowmeters
 - Specify DP & flow rate



- Liquid Filled Dial**
- Reduce vibration errors
 - Slow fluctuations
 - Avoid damage from spikes
 - Eliminate condensation

More Options

Gauge:

- Plastic lens
- Shatterproof lens
- Lexan plastic dial case (3,5 inch dial only)
- Artwork/Logo

Electronics:

- See pages 26-27 for Switch, Relay and Transmitter options

Process

connections:

- 1/2 inch NPT
- 1/8 inch NPT
- BSP
- MS
- Reverse pressure ports

Elastomers: (o-rings or diaphragms)

- Viton
- EPDM
- Fluorosilicone
- Teflon (o-rings only)

Mounting Brackets:

- See page 4

Miscellaneous:

- Teflon coated magnet and spring
- Calibrate on steel
- Clean for oxygen service
- Stainless steel or paper tag
- Top bleed ports

Certifications:

- Certificate of Conformance
- Certificate of Accuracy
- NACE Certification to MR0175
- Material Certification

Common Differential Pressure Ranges

In. H ₂ O	psid	mm H ₂ O	kg/cm ² (bar)	kPa	Additional standard psid ranges available
0-5	–	0-125	–	–	0-200 0-700
0-10	–	0-150	–	–	0-250 0-750
0-15	–	0-400	–	–	0-300 0-800
0-20	–	0-500	–	–	0-400 0-900
0-25	–	0-640	–	–	0-500 0-1000
0-30	0-1	0-720	0-.07	0-7	0-600
0-40	–	0-1000	0-.10	0-10	Compound ranges
0-50	–	0-1200	0-.12	0-12	Series 1518
0-60	0-2	0-1500	0-.15	0-15	8-0-8 psid
0-80	0-3	0-2000	0-.20	0-20	10-0-10
0-100	–	0-2500	0-.25	0-25	15-0-15
0-150	0-5	–	0-.32	0-32	20-0-20
0-200	–	0-5000	0-.50	0-50	25-0-25
	0-8		0-.60	0-60	30-0-30
	0-10		0-.70	0-70	50-0-50
	0-15		0-1	0-100	Series 1835
	0-20		0-1.4	0-140	1-0-1 psid
	0-25		0-1.8	0-180	2-0-2
	0-30		0-2	0-200	3-0-3
	0-35		0-2.5	0-250	5-0-5
	0-40		0-2.8	0-280	8-0-8
	0-50		0-3.6	0-360	5-0-5" H ₂ O
	0-60		0-4	0-400	10-0-10
	0-80		0-5.6	0-560	15-0-15
	0-100		0-7	0-700	20-0-20
	0-125		0-9	0-900	25-0-25
	0-150		0-10	0-1000	30-0-30
					50-0-50
					100-0-100

0-5 to 0-1000 psid
Piston Sensor for Liquids

Features

- Heavy duty — to 10,000 psi line pressure
- Weatherproof design and rugged construction
- Gauge, switch and transmitter versions
- Popular in filtration and flow measurements



Our piston sensor models are for liquid applications where durability and long life are required. Their simple design has fewer parts to wear out and also keeps the price low.

A magnet attached to the dial pointer shaft follows a spring-loaded sensor magnet that moves as differential pressure changes. In this way the DP displacement of the

sensor is translated to our easy-to-read 2.5 to 6-inch diameter dials.

Select from a variety of options such as follower pointers, red arcs and mounting brackets along with switch, relay or transmitter outputs. See page 5 for a complete list of standard options.

Dimensions

Detailed drawings on website.

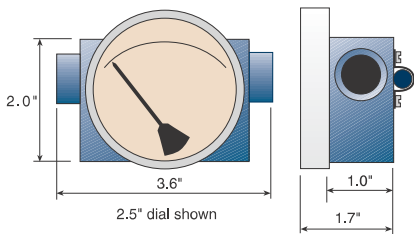

1201PGS

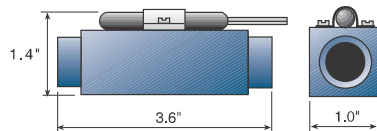

1201PS

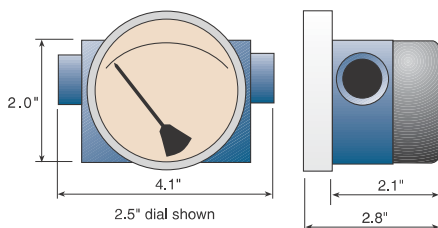

1203PGS

Specifications (Detailed Specification Sheets on Website)

Model	Differential pressure range	Maximum line pressure/temperature	Accuracy (F.S.) (Ascending)	Porting (Many porting types available)	Electrical Available**
1201PG/PGS/PS	0-5 to 0-150 psid (0-0.33 to 0-10 bar)	3000 psig (200 bar) 200°F (93°C)	2%	1/4" NPT	1 switch no enclosure
1203PG/PGS/PS/PGT/PT	0-5 to 0-150 psid (0-0.33 to 0-10 bar)	5000 psig (340 bar) 200°F (93°C)	2%	1/4" NPT	1 or 2 switches 1 relay transmitter Class 1 Div. 2/NEMA 4X For Class 1 Div. 1, see pg. 26
1206PG*	0-5 to 0-150 psid (0-0.33 to 0-10 bar)	10,000 psig (680 bar) 200°F (93°C)	2%	1/4" NPT	1 or 2 switches, 1 relay NEMA 4X
1306PG*	0-100 to 0-1000 psid (0-7 to 0-67 bar)	7500 psig (482 bar) 200°F (93°C)	2%	1/4" NPT	1 or 2 switches, 1 relay NEMA 4X

P=Piston G=Gauge S=Switch T=Transmitter

*PS and PGS transmitter versions available

**NEMA 4X switch models have a 1/2 inch NPT conduit port as standard. A DIN 43650A-PG11 with mating connector is optional, rated IP65 & NEMA 4X

How to Order

Select from each of the applicable categories to construct a model number. Use the model number when ordering or obtaining additional information and pricing from Orange Research or your local distributor.

Reordering? You must supply the Part Number from your instrument label.

Sample Model Number
1201PGS - 1A - 2.5B - A 0-5 psid, 1, 3, E

1201PGS	1A	2.5B	A	0-5 psid	1, 3, E
Model	Pressure Body	Dial Case	Electrical	Range	Options (more on pg. 5)
1201PG 1201PGS 1201PS 1203PG 1203PS 1203PGS 1206PG 1306PG <i>More models above</i>	<i>In-line ports:</i> 1A = aluminum 1C = 316 stainless steel 1E = brass <i>Change "1" above to "4" for back ports; to "5" for bottom ports</i> <i>Back/bottom ports N/A on 1203 or 1300 series; Brass N/A on 1300 series</i>	2.5B = 2.5" basic 3.5B = 3.5" basic 4.5B = 4.5" basic 6B = 6.0" basic <i>Change "B" to "F" above for flanged dial case</i>	A = SPST, N.O. B = SPST, N.C. C = SPDT A-A = 2 ea. - A B-B = 2 ea. - B C-C = 2 ea. - C R2 = relay T2 = transmitter	0-5, 0-8, 0-10, 0-15, 0-20, 0-25, 0-30, 0-35, 0-40, 0-50, 0-60, 0-80, 0-100, 0-125, 0-150 psid <i>1300 series ranges to 1000 psid</i>	1 = 1/2" NPT 2 = plastic lens 3 = liquid filled (glycerine) 4 = follower pointer 5 = Teflon coated magnet/spring 6 = red arc (specify range) 7 = dual scale (specify both) 8 = high temperature Special Seals (Buna-N standard): E = EPDM V = Viton F = Fluorosilicone T = Teflon

0-5" H₂O to 0-50 psid
Diaphragm Sensor for
Liquids or Gases

Features

- **Low DP ranges at high line pressures, down to 0-5 inches H₂O**
- **Rugged, weather-proof design**
- **Gauge, switch and transmitter versions**
- **Popular in filtration, flow and level measurements**



Select these diaphragm sensor models where low differential pressures exist. The popular 1516 model measures from 0-1 psid up to 0-50 psid. Our 1800 series models include our most sensitive diaphragm which can measure from 0-5" H₂O to 0-8 psid. We also offer compound range models with a zero center.

As differential pressure changes the diaphragm sensor magnet moves proportionally. This movement is tracked by a pointer magnet, which rotates, relaying the reading onto an easy-to-read 2.5 to 6 inch dial.

The diaphragm sensor separates the high and low-pressure ports making them popular for gases as well as liquids. There is no bypass between these ports as with our piston models.

Select from a variety of options such as follower pointers, red arcs and mounting brackets along with switch, relay or transmitter outputs. More details on these models can be found on our DP introduction pages 2-5. Electrical details are on pages 26-27.

Dimensions

Detailed drawings on website.

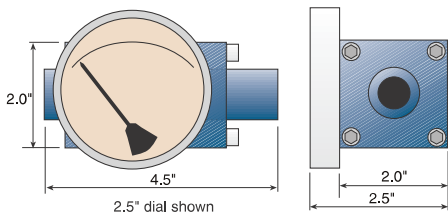

1516DG

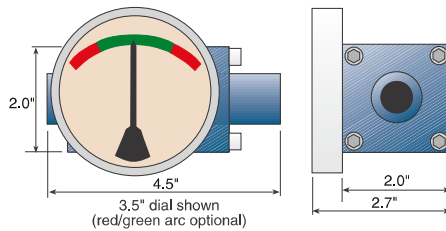

1518DG

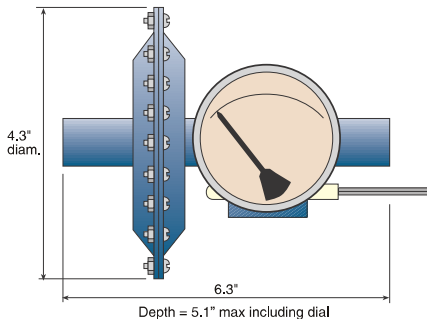

1831DGS

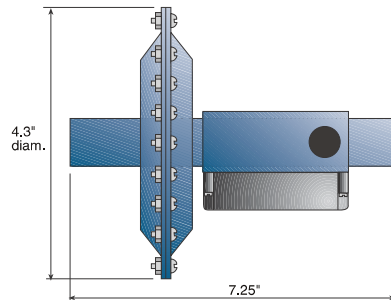

1833DS

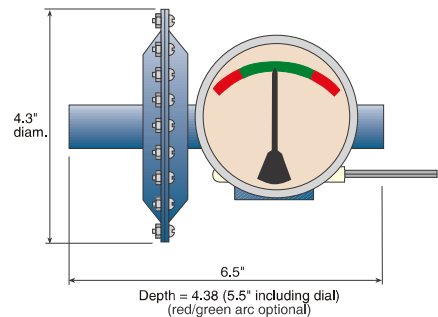

1835DGS

Specifications (Detailed Specification Sheets on Website)

Model	Differential pressure range	Maximum line pressure/temperature	Accuracy (F.S.) (Ascending)	Porting (Many porting types available)	Electrical Available*
1516DG/DGS/DS/DGT/DT	0-1 to 0-50 psid (0-0.07 to 0-3.3 bar)	1500 psig (100 bar)/200°F (93°C)	2%	1/4" NPT	1 or 2 switches transmitter Class 1 Div. 2
1518DG/DGS	10-0-10 to 50-0-50 psid (0.5-0-0.5 to 3.3-0-3.3 bar)	1500 psig (100 bar)/200°F (93°C)	2%	1/4" NPT	1 or 2 switches Class 1 Div. 2
1831DG/DGS	0-5" H ₂ O to 0-8 psid (0-125 mm H ₂ O to 0-0.5 bar)	Aluminum body 100 psig (7 bar)/200°F (93°C) Stainless steel body 150 psig (10 bar)/200°F (93°C)	2%	1/4" NPT	1 or 2 switches No enclosure
1833DGS/DS/DGT/DT	0-5" H ₂ O to 0-8 psid (0-125 mm H ₂ O to 0-0.5 bar)	Aluminum body 100 psig (7 bar)/200°F (93°C) Stainless steel body 150 psig (10 bar)/200°F (93°C)	2%	1/4" NPT	1 or 2 switches 1 relay transmitter Class 1 Div.
1835DG/DGS/DS	5-0-5" H ₂ O to 8-0-8 psid (125 mm-0-125 mm H ₂ O to 0.5-0-0.5 bar)	Aluminum body 100 psig (7 bar)/200°F (93°C) Stainless steel body 150 psig (10 bar)/200°F (93°C)	2%	1/4" NPT	1 or 2 switches No enclosure

D=Diaphragm G=Gauge S=Switch T=Transmitter

*NEMA 4X switch models have a 1/2 inch NPT conduit port as standard. A DIN 43650A-PG11 with mating connector is optional, rated IP65 & NEMA 4X

How to Order

Select from each of the applicable categories to construct a model number. Use the model number when ordering or obtaining additional information and pricing from Orange Research or your local distributor.

Reordering? You must supply the Part Number from your instrument label.

Sample Model Number
1516DGS - 1A - 2.5B - A 0-1 psid, 1, 3, E

1516DGS Model	1A Pressure Body	2.5B Dial Case	A Electrical	0-1 psid Range	1, 3, E Options (more on pg. 5)
1516DG	<i>In-line ports:</i>	2.5B = 2.5" basic	A = SPST, N.O.	Model 1516:	1 = 1/2" NPT
1516DGS	1A = aluminum	3.5B = 3.5" basic	B = SPST, N.C.	0-1, 0-2, 0-3, 0-5, 0-8,	2 = plastic lens
1516DS	1C = 316 stainless steel	4.5B = 4.5" basic	C = SPDT	0-10, 0-15, 0-20, 0-25,	3 = liquid filled (glycerine)
1518DG	1E = brass	6B = 6.0" basic	A-A = 2 ea. - A	0-30, 0-35, 0-40, 0-50	4 = follower pointer
1518DGS			B-B = 2 ea. - B	psid	5 = Teflon coated magnet/spring
1831DG	<i>Change "1" above to</i>	<i>Change "B" to "F"</i>	C-C = 2 ea. - C	Models 1831 & 1833:	6 = red arc (specify range)
1831DGS	<i>"4" for back ports; to</i>	<i>above for flanged</i>	R2 = relay	0-5", 0-10", 0-15", 0-20",	7 = dual scale (specify both)
1833DGS	<i>"5" for bottom ports</i>	<i>dial case</i>	T2 = transmitter	0-25", 0-30", 0-40",	8 = high temperature
1833DS				0-50", 0-60", 0-80",	Special Diaphragm & Seals
1835DG	<i>1518 & 1800 series in-</i>			0-100", 0-150",	(Buna-N standard):
1835DGS	<i>line only; 1835 SS only</i>			0-200" H ₂ O; 0-8 psid	E = EPDM
1835DS					F = Fluorosilicone
<i>More models above</i>				<i>For compound ranges, see p 5</i>	V = Viton
					T = Teflon (o-ring seals only)

0-5 to 0-300 psid

Heavy-duty Diaphragm Sensor for High DP Liquids or Gases

Features

- High DP ranges
- Rugged, weatherproof design
- Gauge, switch and transmitter versions



Our 1502 and 1533 models have a heavy-duty diaphragm that is designed for high differential pressures, to 300 psid. This extends the range of our diaphragm sensor DP line – much higher than the more sensitive 1516 model. Though heavy-duty, the diaphragms are still flexible and repeatable enough to match the $\pm 2\%$ accuracy of our other DP gauges.

Model 1502 is a gauge with a single switch option (uncovered), while our model 1533 is always supplied with up to two switches or a transmitter within a NEMA 4X enclosure.

A rolling diaphragm sensor separates the high and low-pressure ports making these models popular for gases as well as liquids. There is no bypass between the two ports as with our piston models.

As differential pressure changes the diaphragm sensor magnet moves proportionally. This movement is tracked by a pointer magnet, which rotates and displays the reading on an easy-to-read 2.5 to 6 inch dial.

Select from a variety of options such as follower pointers, red arcs and mounting brackets along with switch, relay or transmitter outputs. More details on these models can be found on our DP introduction pages 2-5. Electrical details are on pages 26-27.

Note: Reverse pressure should be avoided with these rolling diaphragm models. If this occurs the diaphragm may not return to its original position.

Dimensions

Detailed drawings on website.

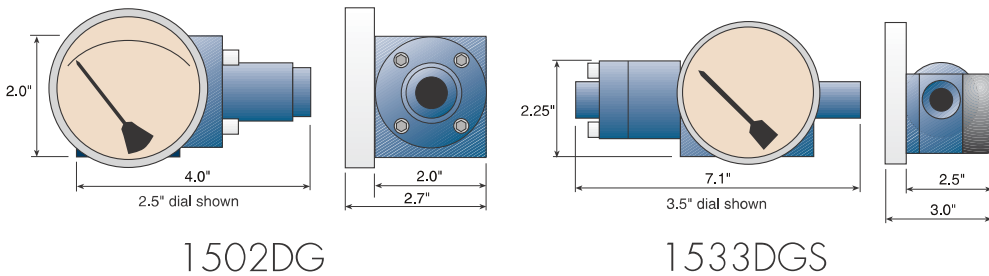

Specifications (Detailed Specification Sheets on Website)

Model	Differential pressure range**	Maximum line pressure/temperature	Accuracy (F.S.) (Ascending)	Porting (Many porting types available)	Electrical Available***
1502DG	0-10* to 0-300 psid (0-0.33 to 0-20 bar)	3000 psig (200 bar)/200°F (93°C)	2%	1/4" NPT	Not available
1533DGS/DS/DGT/DT	0-10* to 0-300 psid (0-0.33 to 0-20 bar)	3000 psig (200 bar)/200°F (93°C)	2%	1/4" NPT	1 or 2 switches NEMA 4X transmitter

D=Diaphragm G=Gauge S=Switch T=Transmitter

*Fluorosilicone diaphragm is standard for 0-10 psid, Buna diaphragm is standard for above 0-10 psid

**Ranges available by diaphragm material:

- Fluorosilicone: 0-10 to 0-300 psid
- Buna: 0-15 to 0-300 psid
- EPDM: 0-15 to 0-300 psid
- Viton: 0-25 to 0-300 psid

***NEMA 4X switch models have a 1/2 inch NPT conduit port as standard. A DIN 43650A-PG11 with mating connector is optional, rated IP65 & NEMA 4X

How to Order

Select from each of the applicable categories to construct a model number. Use the model number when ordering or obtaining additional information and pricing from Orange Research or your local distributor.

Reordering? You must supply the Part Number from your instrument label.

Sample Model Number
1533DGS - 1A - 2.5B - A 0-5 psid, 1, 3, E

1533DGS	1A	2.5B	A	0-5 psid	1, 3, E
Model	Pressure Body	Dial Case	Electrical	Range	Options (more on pg. 5)
1502DG	<i>In-line ports:</i>	2.5B = 2.5" basic	A = SPST, N.O.	0-10, 0-15, 0-20, 0-25,	1 = 1/2" NPT
1533DGS	1A = aluminum	3.5B = 3.5" basic	B = SPST, N.C.	0-30, 0-35, 0-40, 0-50,	2 = plastic lens
1533DS	1C = 316 stainless steel	4.5B = 4.5" basic	C = SPDT	0-60, 0-80, 0-100,	3 = liquid filled (glycerine)
	1E = brass	6B = 6.0" basic	A-A = 2 ea. - A	0-125, 0-150, 0-200,	4 = follower pointer
<i>More models above</i>	<i>Change "1" above to "4" for back ports; to "5" for bottom ports</i>	<i>Change "B" to "F" above for flanged dial case</i>	B-B = 2 ea. - B	0-250, 0-300 psid	5 = Teflon coated magnet/spring
	<i>Back/bottom ports and brass N/A on 1533 series</i>		C-C = 2 ea. - C		6 = red arc (specify range)
			R2 = relay		7 = dual scale (specify both)
			T2 = transmitter		8 = high temperature
					Special Diaphragm & Seals (See standards above)
					E = EPDM
					F = Fluorosilicone
					V = Viton
					T = Teflon (o-ring seals only)

0-5" H₂O to 0-300 psid
Piston or Diaphragm
Sensors with Explosion-
Proof Enclosures
for Switches, Relays
or Transmitters

Features

- **Class 1, Div. 1 rated enclosures**
- **Rugged, weatherproof design**
- **Gauge, switch and transmitter versions**



Our Class 1, Div. 2 enclosures found throughout this catalog are popular for hazardous environments where explosive gases or vapors *may* be present. Our Class 1, Div. 1 *Explosion-proof* line, expands on that protection. The heavy-duty enclosures are designed to seal the electronics from environments where flammable gases or vapors *often* exist and to contain any potential explosions.

The switches and electrical connections are housed in special UL, CSA, FM and ATEX approved enclosures. The cast aluminum housings have two mounting lugs, two 3/4" NPT electrical conduit ports, and meet the following specifications: Class 1, Gr. B, C, & D; Class 2, Gr. E, F, & G; and Class 3. They also meet NEMA 3, 4X, 7, 9, & 12 specifications.

This explosion-proof line incorporates the same piston or diaphragm sensors and pressure bodies found in the preceding pages. We add an additional extension pin with a secondary magnet to trigger our reed switches or to control transmitter output. The secondary magnet and electronics are located in a sealed explosion-proof box adjacent to the pressure body.

Select from a variety of options such as follower pointers, red arcs and mounting brackets along with switch, relay or transmitter outputs. More details on these models can be found on our DP introduction pages 2-5. Electrical details are on pages 26-27.

Dimensions

Detailed drawings on website.

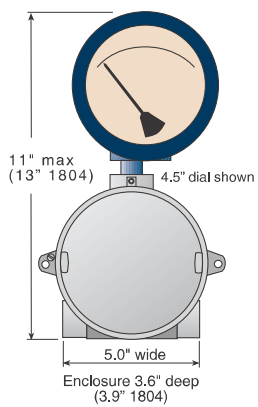

1204PGS, 1504DGS,
1514DGS, 1804DGS

How it Works

Variations between the low pressure and high pressure ports create an imbalance causing the piston or diaphragm sensor **1** to move in proportion to the change. A primary magnet **2** is attached to the pressure sensor and also moves with it in proportion to the differential in pressure.

The motion of the primary magnet is tracked by a rotary magnet **3** located in a separate body cavity. The rotary magnet moves a pointer on a dial indicating differential pressure. Process fluids are isolated from the dial case and switch enclosure.

A secondary follower magnet **4** located in a pressure extension tube also moves with the pressure sensor. Reed switches, mounted externally on the pressure extension tube, are activated when the field of the secondary magnet interacts with the switch elements at a preset point closing or opening the contacts.

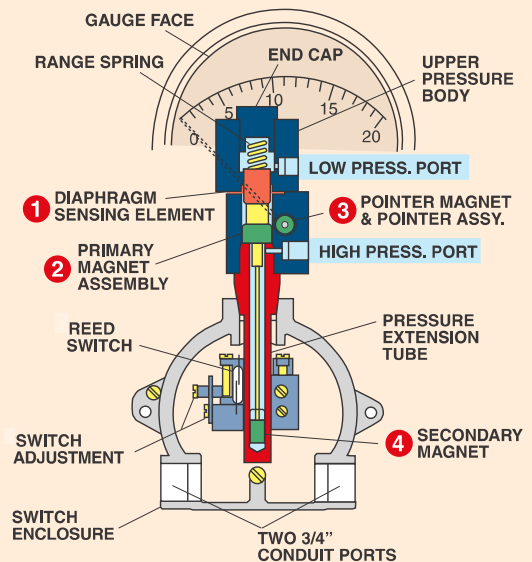

Specifications (Detailed Specification Sheets on Website)

Model	Differential pressure range	Maximum line pressure/temperature	Accuracy (F.S.) (Ascending)	Porting (Many porting types available)	Electrical Available
1204PGS/PS/PGT/PT	0-5 to 0-150 psid (0-0.33 to 0-10 bar)	5000 psig (340 bar)/200°F (93°C)	2%	1/4" NPT	1 or 2 switches 1 or 2 relays transmitter Class 1 Div. 1
1504DGS/DS/DGT/DT	0-5 to 0-300 psid (0-0.33 to 0-20 bar)	3000 psig (100 bar)/200°F (93°C)	2%	1/4" NPT	1 or 2 switches 1 or 2 relays transmitter Class 1 Div. 1
1514DGS/DS/DGT/DT	0-1 to 0-50 psid (0-0.07 to 0-3.3 bar)	1500 psig (100 bar)/200°F (93°C)	2%	1/4" NPT	1 or 2 switches 1 or 2 relays transmitter Class 1 Div. 1
1804DGS/DS/DGT/DT	0-5" H ₂ O to 0-8 psid (0-125 mm H ₂ O to 0-0.5 bar)	Aluminum body 100 psig (7 bar)/200°F (93°C) Stainless steel body 150 psig (10 bar)/200°F (93°C)	2%	1/4" NPT	1 or 2 switches 1 or 2 relays transmitter Class 1 Div. 1

P=Piston D=Diaphragm G=Gauge S=Switch T=Transmitter

How to Order

Select from each of the applicable categories to construct a model number. Use the model number when ordering or obtaining additional information and pricing from Orange Research or your local distributor.

Reordering? You must supply the Part Number from your instrument label.

Sample Model Number
1204PGS - 1A - 3.5B - A 0-5 psid, 1, 3, E

1204PGS	1A	3.5B	A	0-5 psid	1, 3, E
Model	Pressure Body	Dial Case	Electrical	Range	Options (more on pg. 5)
1204PGS 1204PS 1504DGS 1504DS 1514DGS 1514DS 1804DGS 1804DS	<i>In-line ports:</i> 1A = aluminum 1C = 316 stainless steel 1804 SS only	3.5B = 3.5" basic 4.5B = 4.5" basic 6B = 6.0" basic Change "B" to "F" above for flanged dial case	A = SPST, N.O. B = SPST, N.C. C = SPDT A-A = 2 ea. - A B-B = 2 ea. - B C-C = 2 ea. - C R1A = 1 relay R2D = 2 relays T2 = transmitter	Model 1204: 0-5, 0-8, 0-10, 0-15, 0-20, 0-25, 0-30, 0-35, 0-40, 0-50, 0-60, 0-80, 0-100, 0-125, 0-150 psid Model 1504: In addition to above 0-200, 0-250, 0-300 psid Model 1514: 0-1, 0-2, 0-3, 0-5, 0-8, 0-10, 0-15, 0-20, 0-25, 0-30, 0-35, 0-40, 0-50 psid Model 1804: 0-5", 0-10", 0-15", 0-20", 0-25", 0-30", 0-40", 0-50", 0-60", 0-80", 0-100", 0-150", 0-200" H ₂ O; 0-8 psid	1 = 1/2" NPT 2 = plastic lens 3 = liquid filled (glycerine) 4 = follower pointer 5 = Teflon coated magnet/spring 6 = red arc (specify range) 7 = dual scale (specify both) 8 = high temperature Special Diaphragm & Seals (Buna-N standard) Model 1204 (o-ring seals only): E = EPDM V = Viton F = Fluorosilicone T = Teflon Models 1504, 1514 & 1804: E = EPDM V = Viton F = Fluorosilicone
<i>More models above</i>					

0-25" H₂O to 0-100 psid
Piston & Diaphragm
Sensors for Liquids
or Gases

Features

- **Small size**
- **Low cost**
- **Rugged**
- **OEM friendly design**



We refer to these smaller versions of our differential pressure line as indicators. A 1-inch diameter dial with a simple red/green arc is standard to indicate normal operation and alarm conditions. The interface between the red and green portions of the arc is located at 70% of the full scale on standard models.

Made of a chemical and impact resistant clear molded plastic, the dial has a wide viewing angle. Popular where the graduated scales and higher accuracy of our full-size DP line are not necessary, they have $\pm 5\%$ accuracy and a low price to suit your budget.

Our 1002 series piston models are the lowest cost option

for liquid applications. Though small, they are the favorites for OEM requirements and measure from 0-1 to 0-100 psid. Our 1020 series diaphragm models are more sensitive and measure from 0-25" H₂O to 0-30 psid.

We offer an optional SPST or SPDT, hermetically sealed reed switch, where an output is required. Our DP switch models, with no dial, are also popular.

A larger 2-inch dial with a graduated scale is available for higher resolution measurements. Also common are our optional green/yellow/red arcs. Or you can specify our level measurement arcs where the red alarm condition is at the lower end of the scale.

Dimensions

Detailed drawings on website.

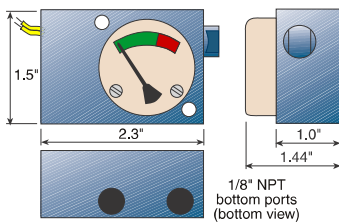

1002PIS-15A

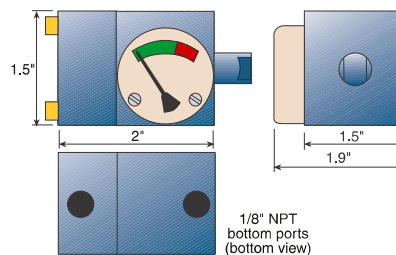

1020DI-5A

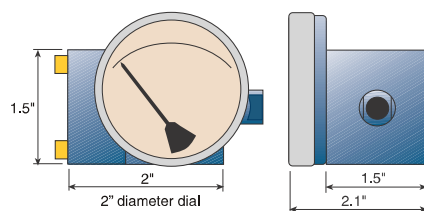

1020DI-1A

Specifications (Detailed Specification Sheets on Website)

Model	Differential pressure range	Maximum line pressure/temperature	Accuracy (F.S.) (Ascending)	Porting (Many porting options available)	Electrical Available**
1002PI/PIS	0-1 to 0-100 psid (0-0.07 to 0-7 bar)	3000* psig (200 bar)/200°F (93°C)	5%	1/8" NPT	1 switch
1020DI/DIS	0-25" H ₂ O to 0-30 psid (0-0.06 to 0-2 bar)	1000 psig (67 bar)/200°F (93°C)	5%	1/8" NPT	1 or 2 switches

P=Piston D=Diaphragm I=Indicator S=Switch

*5000 psig model available on request

**A DIN 43650C-PG7 with mating connector is optional, rated IP65

How to Order

Select from each of the applicable categories to construct a model number. Use the model number when ordering or obtaining additional information and pricing from Orange Research or your local distributor.

Reordering? You must supply the Part Number from your instrument label.

Sample Model Number
1002PIS - 1A - 1M - A 0-1 psid, V

1002PIS	1A	1M	A	0-5 psid	V
Model	Pressure Body	Dial Case	Electrical	Breakpoint/Setpoint	Options
1002PI 1002PIS 1020DI 1020DIS	1A = in-line ports 3A = manifold back ports 4A = 1/8" NPT back ports 5A = 1/8" NPT bottom ports 15A = 1/8" NPT bottom ports w/1/4" conduit port <i>In-line porting N/A with 1002 series</i>	1M = 1" molded lens (std.) 2L = 2" SS bezel	A = SPST, N.O. B = SPST, N.C. C = SPDT	0-25" H ₂ O; 0-1, 0-2, 0-3, 0-5, 0-8, 0-10, 0-15, 0-20, 0-25, 0-30, 0-35, 0-40, 0-50, 0-60, 0-80, 0-100 psid	Model 1002: Special Seals (Buna-N standard): V = Viton Model 1020: Special Diaphragm & Seals (Buna-N standard): E = EPDM F = Fluorosilicone V = Viton

In-line Flowmeters

Orange offers a broad line of in-line flowmeters for liquids with $\pm 2\%$ accuracy, or air and gas with an accuracy of $\pm 5\%$. Built for both low and high flow rates they are found in many industrial applications. They monitor oil, water, chemicals and a variety of non-corrosive and/or corrosive liquids or gases. The pressure bodies are machined from solid aluminum, brass or stainless steel. Our internal sensors are sensitive but rugged and are offered in a broad selection of designs and materials.

We offer two basic sensor models. Our popular Variable-Area flowmeters handle flows from 0-1 GPM to 0-30 GPM and to 5,000 psi line pressures. Our fixed-orifice

flowmeters handle the lower flow rates, from 0-2 GPH to 0-40 GPH, and to 3,000 psi. Both sensor models are rugged and reliable and withstand pressure spikes without degradation of the sensor accuracy.

Our flowmeters have an easy-to-read dial, from 2.5 to 4.5 inch diameter, to allow for local indication of the flow rate. We offer an output from one or two SPST or SPDT hermetically sealed switches. Flow transmitters are also available with voltage and current outputs. These electronics are offered independently or in combination with the dials.

Applications

- Cooling systems
- Heat exchangers
- Lubrication and bearing equipment
- Hydraulic systems
- Hydraulic testers
- Pneumatic systems
- Process monitoring
- Flow alert and alarm systems
- Boiler and heater applications
- Laboratory flow monitors

Three Basic Components

Select with all three components or:

- Drop the dial case for a flowswitch model
- Drop the switch for a flowmeter model

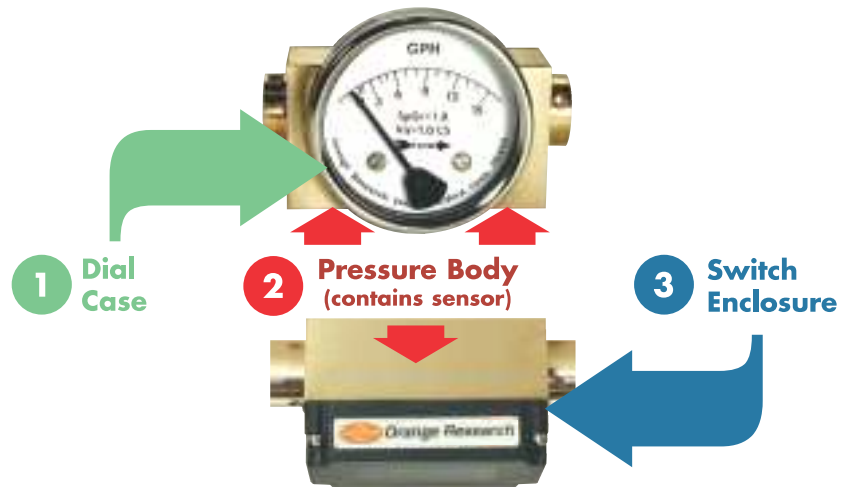

Standard horizontal orientation shown—
Select vertical orientation at no extra charge

How They Work

The flow rate results in movement of a variable-area cone sensor from a precision orifice or the movement of a fixed-orifice/diaphragm sensor. Both sensor types are spring loaded. In each, the sensor magnet movement is

tracked by the pointer magnet, which rotates, indicating the flow rate on a large easy-to-read scale. The reed switch actuates as the sensor magnet moves into proximity.

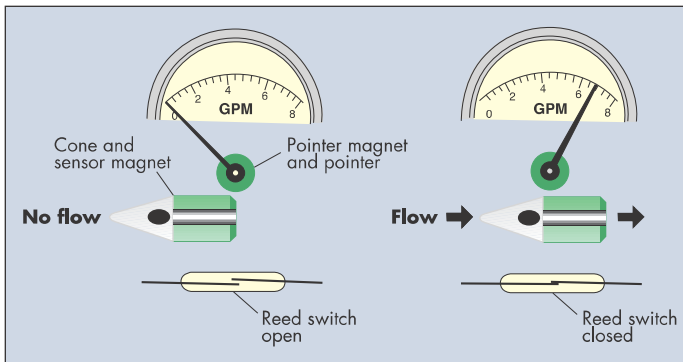

Variable-area flowmeter

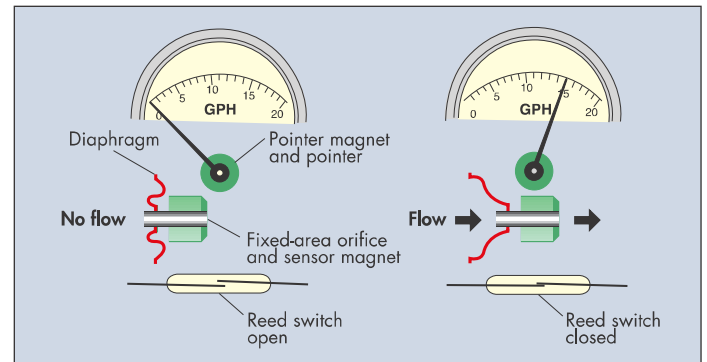

Fixed-orifice flowmeter

Variable-area vs. fixed-orifice

Our fixed-orifice models are best for low flow applications. They are able to measure down to 2 GPH, so small changes in flow rate can be seen and users alerted. Because these models use a fixed orifice, users must consider two factors: abrasive fluids and fluids that may leave deposits. This can affect accuracy over time by changing the size of the orifice.

Our variable-area models use a larger orifice and a movable flow cone, which reduces the potential for clogging. We offer specially designed flow cones for use under harsh conditions where dirt and debris may be present, such as in wastewater or construction site environments. Another benefit is the variable-area sensor allows for readings on a linear scale, often preferred over square root meters.

The Orange Advantage in Flow

Easy-to-read scale

Our flowmeters have large, bold scales against a bright white background, on 2.5 to 4.5 inch diameter dials. This results in high resolution readings from a distance and allows for the high accuracy to be fully utilized.

Compare these to rotameters or similar designs that have small scales that are difficult to read in many environments. This is especially true with rotameters that cannot be read with dirty or opaque fluids. Our new customers appreciate not having to deal any longer with the difficult-to-read “thermometer look” of competing flowmeters.

High line-pressure

Our flowmeters are machined from solid blocks of metal that withstand up to 5,000 psi. Compare this to rotameters that handle up to 150 psi.

Our spring-loaded sensors naturally withstand shock and vibration along with flow and pressure spikes without degradation in accuracy. Compare this to some competitors’ designs where the indicator position can be lost, resulting in maintenance to restore normal functions.

Mount in any orientation

Our sensors are spring-loaded allowing for vertical or horizontal mounting. This allows for flexibility of design and space savings. Why limit yourself to being forced to run an extra vertical line where it is not necessary? Often the space constraints do not allow for an extra run of vertical pipe. We offer horizontal as standard and vertical mounting as a no charge option.

Standard Flow Ranges

LIQUID

GPH	GPM	LPH	LPM
2		8	120 ml/min
4		15	
5		20	300 ml/min
8		30	500 ml/min
10		40	
15		60	1000 ml/min
20		75	
40		150	
	1		4
	2		8
	3		12
	4		15
	5		20
	6		25
	8		30
	10		40
	15		60
	20		75
	25		95
	30		110

AIR & GAS

SCFM	SLPM	Nm ³ /hr
1.5-5	60-140	3-8
1.5-10	40-280	3-15
2-15		3-25
3-20	60-560	3-30
3-25	70-700	4-40
3-30	100-850	5-50
4-40		5-80
5-50		10-90
5-75		15-125
10-100		20-150

Calibration

One of the three standard calibration types or special calibration (with conditions) must be specified at order placement:

A. Standard calibration on water:

- Meters are calibrated using water
- S.G. = 1.0 & Viscosity = 1.0 CS @ 70°F

B. Standard calibration on oil:

- Meters are calibrated using oil
- S.G. = 0.86 & Viscosity = 78 CS @ 74°F

C. Standard calibration on air:

- Meters are calibrated using air
- 100 psig @ 70°F

Special calibration for liquids

(other than water or oil, as described in A or B):

- Using water or oil and a conversion procedure, meters will be calibrated to conform to the SG and the viscosity of the customer's in-service fluid (viscosities up to 150 CS). Accuracy = ±10% F.S.
- Specify Specific Gravity and Viscosity

Special calibration for gas

(other than air as described in C):

- Using air and a conversion procedure meters will be calibrated to conform to customer's gas, pressure and temperature.
- Specify temperature, pressure and gas

Flowmeter Notes

- Filtration is required if particle size exceeds 500 microns for 2020 Series and 50 microns for 2200, 2300 and 2400 Series.
- To avoid turbulent flow we recommend installing our flowmeters 10 pipe diameters upstream and 5 pipe diameters downstream of pipe turns.
- Mount our flowmeters 1 inch from ferromagnetic surfaces to avoid magnetic sensor interference. Special calibration on steel is available (see options).

Options

Dial/Scale:

- Plastic lens
- Shatterproof lens
- Liquid filling (glycerine)
- Red arc
- Multicolor arc
- Dual scale

O-ring seals:

- Viton
- EPDM
- Fluorosilicone
- Teflon

Miscellaneous:

- Teflon-coated spring (magnet always Teflon-coated)
- Teflon metering cone on 2220, 2320
- Calibrate on steel (steel affects magnet)
- Stainless steel or paper tag
- Reverse flow
- Vertical flow (horizontal std)

Density Correction Factors — Air & Gas Flow

Gas density can have an effect on the accuracy of the flow reading. Since gases are very compressible the density is an especially important factor. Temperature or pressure changes in a gas can expand or compress a gas resulting in a change in the density. Measuring the flow of a gas other than the one used in the calibration of the flowmeter without taking these factors into account can result in inaccurate readings.

Below we list correction factors for pressures, temperatures or specific gravities other than those used for calibration of our flowmeters. The formulas supplied allow for the calculation of the flow rate using these correction factors. An example is also supplied.

For values not listed on the reference tables below, use equations at right to determine correction factors.

Pressure correction factor, X_P

PSIG	25	50	75	100	125	150	175	200
BAR	1.7	3.4	5.2	6.9	8.6	10.3	12.1	13.8
kPA	172	345	517	689	862	1034	1207	1379
X_P	.69	.75	.88	1.0	1.1	1.2	1.29	1.37

$$X_P = \sqrt{\frac{14.7 + \text{PSIG}}{114.7}} \quad X_P = \sqrt{\frac{1.01 + \text{BAR}}{7.91}} \quad X_P = \sqrt{\frac{101.4 + \text{kPa}}{790.9}}$$

Temperature correction factor, X_T

°F	10	30	50	70	90	110	130	150	170	190
°C	-12.2	-1.0	10	21.1	32.2	43	54	66	77	88
X_T	1.06	1.04	1.02	1.0	.98	.96	.95	.93	.92	.90

$$X_T = \sqrt{\frac{530}{460 + ^\circ\text{F}}} \quad X_T = \sqrt{\frac{294}{273 + ^\circ\text{C}}}$$

Specific Gravity correction factor, X_{SG}

Gas	Air	Nitrogen (N ₂)	Carbon Dioxide (CO ₂)	Natural Gas	Hydrogen (H ₂)	Oxygen (O ₂)
SG	1.0	.97	1.53	.60	.07	1.1
X_{SG}	1.0	1.02	.81	1.29	3.78	.95

$$X_{SG} = \sqrt{\frac{1}{SG}}$$

Calculation: SCFM_{indicated} (X_P) (X_T) (X_{SG}) = SCFM_{actual}

- Notes: 1. All three correction factors may not apply.
2. Pressure and temperature conditions are to be taken at the inlet of the gauge.

Example: **Standard air meter reads 50 SCFM**, but application gas is CO₂ at 80 PSIG, 90°F.
What is the actual flow?

$$X_P = \sqrt{\frac{14.7 + 80}{114.7}} = 0.91 \quad X_T = \sqrt{\frac{530}{460 + 90}} = 0.98 \quad X_{SG} = \sqrt{\frac{1}{1.53}} = 0.81$$

$$50 \text{ SCFM}_{\text{indicated}} (0.91) (0.98) (0.81) = \mathbf{36 \text{ SCFM}_{\text{actual}}}$$

0-2 to 0-40 GPH
1.5-5 SCFM

Fixed-Orifice Flow
for Low Flow Rates –
Liquids or Gases

Features

- Large, easy-to-read dial
- Rugged, high line pressure design
- Vertical or horizontal mounting



2021FG



2021FS

Our fixed-orifice flowmeters are designed for low flow applications, from 0-2 to 0-40 GPH. Like our variable-area flowmeters they are built from solids blocks of metal making them a favorite for high line pressure applications, to 3000 psi. You will find many in hydraulic and pneumatic systems.

Though rugged, they maintain the sensitivity required for low flow measurements. We use a fixed Delrin orifice centered on a spring-loaded Buna-N diaphragm-magnet sensor, which provides sensitive responses to changes in flow. This diaphragm sensor is magnetically coupled to a pointer, which relays the flow rate onto an easy-to-read square-root calibrated dial.

These in-line flowmeters often replace rotameters, which have small scales that can be difficult to read, especially

with dirty or opaque fluids. Our 2.5 to 4.5 inch dials with large, bold markings can be read from a distance. The spring-loaded sensor allows them to be oriented either horizontally or vertically. Many others must be mounted vertically only, limiting space and design flexibility.

We offer them with pressure bodies (and wetted parts) of aluminum or stainless steel. Choose from a wide selection of standard options such as liquid filled dials, reverse flow, red arc scales and many more. More details on these models can be found in our flow introduction pages 16-19.

Reed switches and relays can accompany the meters or be supplied on their own, without a dial. Electrical details are on pages 26-27.

Dimensions

Detailed drawings on website.

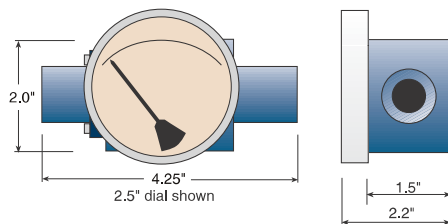

2021FG

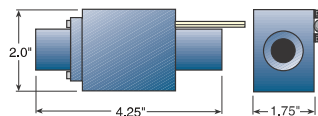

2021FS

Specifications (Detailed Specification Sheets on Website)

Model	Flow range	Porting	Maximum line pressure/temperature	Accuracy (F.S.)/repeatability	Turndown*	Electrical Available*
2021FG/FGS/FS	Liquids 0-2 to 0-40 GPH (0-8 to 0-150 LPH) Air & Gas 1.5-5 SCFM (60-140 SLPM)	1/4" NPT	3000 psig (200 bar) 200°F (93°C)	Liquids 2%/1% Air & Gas 5%/1%	3:1	2 switches

F=Flow G=Gauge S=Switch

*Turndown results in 1st mark at approximately 30% of full scale

How to Order

Select from each of the applicable categories to construct a model number. Use the model number when ordering or obtaining additional information and pricing from Orange Research or your local distributor.

Reordering? You must supply the Part Number from your instrument label.

Sample Model Number
2021FGS - 1A - 2.5B - A 0-2 GPH-W, 5T

2021FGS	1A	2.5B	A	0-2 GPH	W	5T
Model	Flow Body	Dial Case	Electrical	Range	Calibration	Options (more on pg. 19)
2021FG 2021FGS 2021FS	1A = aluminum 1C = 316 SS	2.5B = 2.5" basic 3.5B = 3.5" basic 4.5B = 4.5" basic <i>Change "B" to "F" above for flanged dial case</i>	A = SPST, N.O. B = SPST, N.C. C = SPDT A-A = 2 ea. -A B-B = 2 ea. -B C-C = 2 ea. -C R2 = relay	Liquid 0-2, 0-4, 0-5, 0-8, 0-10, 0-15, 0-20, 0-25, 0-40 GPH Air & Gas 1.5-5 SCFM	W = std. calibr. -water O = std. calibr. -oil A = std. calibr. -air S = special calibr.* *Liquids: must specify specific gravity and viscosity *Gas: must specify gas, pressure and temperature See std. calibration conditions page 26	5 = plastic lens 6 = liquid fill (glycerine) 8 = reverse flow 9 = vertical flow (specify direction – up or downward) Special Seals (Buna-N standard): T = Teflon V = Viton

Flow Curves

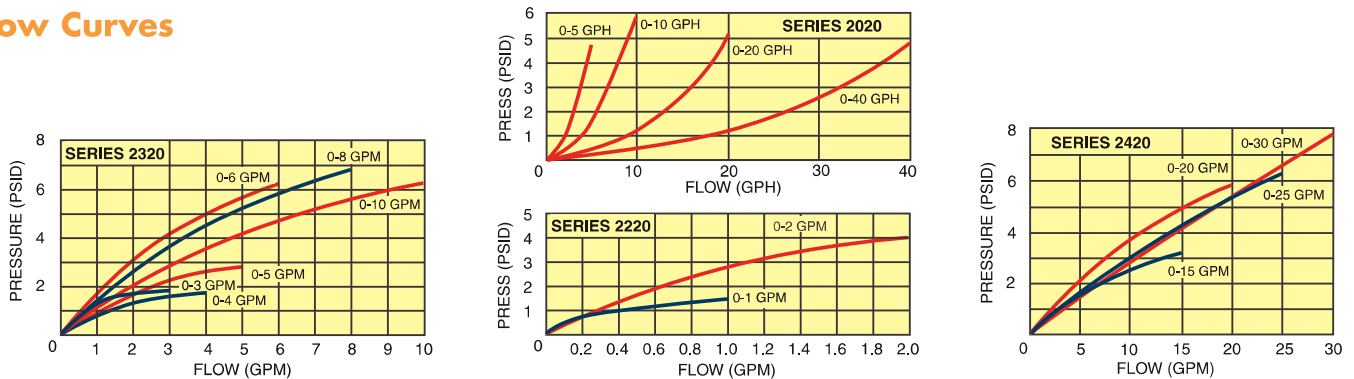

0-1 to 0-30 GPM
1.5-10 to 1-100 SCFM
 Variable-Area Flow
 for Liquids or Gases

Features

- Large, easy-to-read dial
- Rugged, high line pressure design
- Vertical or horizontal mounting



Our variable-area flowmeters are designed for liquid or gas applications where rotameters often fall short. These models have large dials with bold markings and characters that are easy to read from a distance. They also handle high line pressures and can be mounted in any orientation.

Like rotameters, they are mounted directly in the flow stream, but with bodies machined from solid blocks of metal, they handle high-pressure applications of up to 5000 psi (vs 150 psi for rotameters). This makes them a natural for hydraulic systems.

The variable-area sensor, a movable Delrin cone (2200 & 2300) or Teflon cone (2400), rests in a precision orifice.

Fluid flow causes the sensor to move from the orifice and against a stainless steel spring while the flow rate is indicated on an easy-to-read dial face.

We offer them with pressure bodies (and wetted parts) of aluminum, stainless steel or brass. A variety of dial sizes are available, from 2.5 inch to 4.5 inch.

Choose from a wide selection of dial, porting, seal and calibration options. Switches, relays and transmitters are available with the dial or as stand-alone instruments. More details on these models can be found on our flow introduction pages 16-19. Electrical details are on pages 26-27.

Dimensions

Detailed drawings on website.

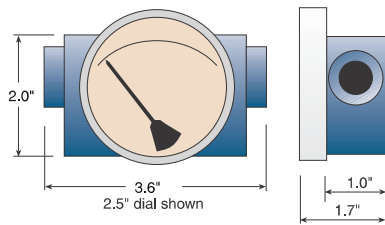

2221FG

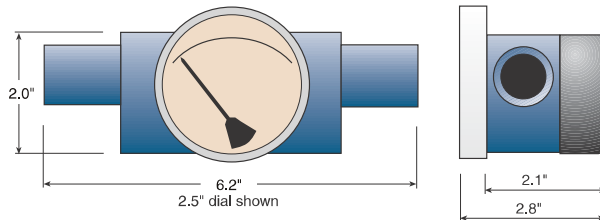

2323FGS

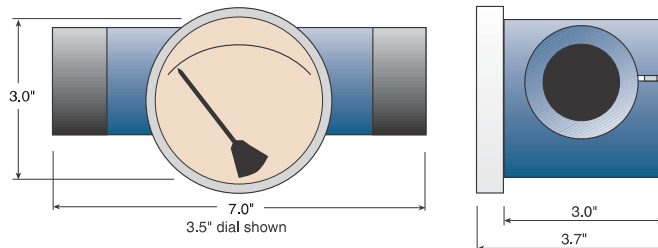

2421FG

Specifications (Detailed Specification Sheets on Website)

Model	Flow range	Porting	Maximum line press./temp.	Accuracy (F.S./repeatability)	Turndown*	Electrical Available**
2221FG/FGS/FS	<u>Liquids</u> 0-1 to 0-5 GPM (0-4 to 0-18 LPM) <u>Air & Gas</u> 1.5-10 to 3-25 SCFM (40-280 to 75-700 SLPM)	1/4" NPT	3000 psig (200 bar) 200°F (93°C)	<u>Liquids</u> 2%/1% <u>Air & Gas</u> 5%/1%	10:1	1 or 2 switches
2223FGS/FS/FGT/FT	<u>Liquids</u> 0-1 to 0-5 GPM (0-4 to 0-18 LPM) <u>Air & Gas</u> 1.5-10 to 3-25 SCFM (40-280 to 75-700 SLPM)	1/4" NPT	5000 psig (200 bar) 200°F (93°C)	<u>Liquids</u> 2%/1% <u>Air & Gas</u> 5%/1%	10:1	1 or 2 switches 1 relay transmitter NEMA 4X Class 1-Div. 2
2321FG/FGS/FS	<u>Liquids</u> 0-1 to 0-10 GPM (0-4 to 0-18 LPM) <u>Air & Gas</u> 4-30 to 10-100 SCFM (100 to 850 SLPM)	1/2" NPT	3000 psig (200 bar) 200°F (93°C)	<u>Liquids</u> 2%/1% <u>Air & Gas</u> 5%/1%	10:1	1 or 2 switches
2323FGS/FS/FGT/FT	<u>Liquids</u> 0-1 to 0-10 GPM (0-3.8 to 0-38 LPM) <u>Air & Gas</u> 4-30 to 10-100 SCFM (100-850 SLPM)	1/2" NPT	5000 psig (340 bar) 200°F (93°C)	<u>Liquids</u> 2%/1% <u>Air & Gas</u> 5%/1%	10:1	1 or 2 switches 1 relay transmitter NEMA 4X Class 1-Div. 2
2421FG/FGS/FS	<u>Liquids Only</u> 0-10 to 0-30 GPM (0-36 to 0-110 LPM)	1" NPT	1500 psig (100 bar) 200°F (93°C)	2%/1%	10:1	1 or 2 switches
2423FGS/FS	<u>Liquids Only</u> 0-10 to 0-30 GPM (0-36 to 0-110 LPM)	1" NPT	1500 psig (100 bar) 200°F (93°C)	2%/1%	10:1	1 or 2 switches 1 relay NEMA 4X

F=Flow G=Gauge S=Switch T=Transmitter

*Turndown results in 1st mark at approximately 10% of full scale

**NEMA 4X switch models have a 1/2 inch NPT conduit port as standard. A DIN 43650A-PG11 with mating connector is optional, rated IP65 & NEMA 4X

How to Order

Select from each of the applicable categories to construct a model number. Use the model number when ordering or obtaining additional information and pricing from Orange Research or your local distributor.

Reordering? You must supply the Part Number from your instrument label.

Sample Model Number

2221FGS - 1A - 2.5B - A 0-1 GPM-W, 5T

2221FGS	1A	2.5B	A	0-1 GPM	W	5T
Model	Flow Body	Dial Case	Electrical	Range	Calibration	Options (more on pg. X)
2221FG	1A = aluminum	2.5B = 2.5" basic	A = SPST, N.O.	<u>Liquid</u>	W = std. calibr. -water	5 = plastic lens
2221FGS	1C = 316 SS	3.5B = 3.5" basic	B = SPST, N.C.	0-1, 0-2, 0-3, 04,	O = std. calibr. -oil	6 = liquid fill (glycerine)
2221FS	1E = brass	4.5B = 4.5" basic	C = SPDT	0-5, 0-8, 0-10, 0-15,	A = std. calibr. -air	8 = reverse flow
2223FGS		Change "B" to "F" above for flanged dial case	A-A = 2 ea. -A	0-20, 0-25, 0-30	S = special calibr.*	9 = vertical flow (specify direction - up or downward)
2223FS			B-B = 2 ea. -B	GPM	* <u>Liquids</u> : must specify specific gravity and viscosity	Special Seals (Buna-N standard):
2321FG			C-C = 2 ea. -C	<u>Air & Gas</u>	* <u>Gas</u> : must specify gas, pressure and temperature	T = Teflon
2321FGS			R2 = relay	2220 Series:	See std. calibration conditions page 18	V = Viton
2321FS			T2 - transmitter	1.5-10, 2-15, 3-20, 3-25 SCFM		
2323FGS				2320 Series:		
2323FS				4-30, 4-40, 5-50, 5-75, 10-100 SCFM		
<i>More models above</i>						

0.1 to 1.5 GPM

Piston Sensor for Liquids

Features

- Compact size
- Low cost
- OEM design
- Brass or stainless steel



Our 30000 Series fixed set-point flow switches have factory-preset settings. The many features and the adjustability found on our other models have been designed out.

Their compact size and basic profile results in low cost switches that can be mounted where space is limited. This makes them popular for OEM applications where simple flow switch actuation is required.

Rugged materials are used to allow for long-term, high-pressure use. The switches are popular for portable systems where shock and vibration are common. Stainless steel springs and brass or stainless steel pistons and pressure bodies allow for use in a variety of applications.

Applications

- Lubricating systems
- Chillers, coolers
- Heat exchangers

Dimensions

Detailed dimensional information is available on the Orange Research website.

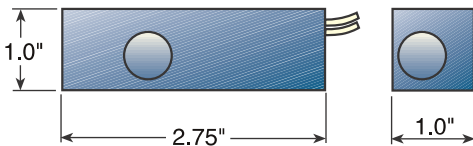

30000 Series

How it works

Designed for in-line use, the fluid enters the end connection and exits the side port. As the fluid passes through the unit it pushes against a spring-loaded piston magnet sensor. As the sensor magnet moves into proximity of the reed switch the switch is actuated.

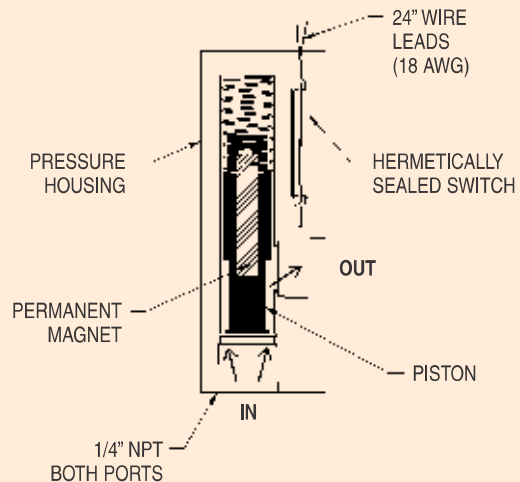

Specifications (Detailed Specification Sheets on Website)

Set-points	0.1, 0.25, 0.5, 0.75, 1.0, 1.5 GPM
Wetted parts – Brass models	Brass and stainless steel
Wetted parts – SS models	Stainless steel
Maximum pressure	1000 psig (200 bar)
Accuracy	10% FS
Repeatability	1%
Deadband	20% max.
Temperature	-20°F to +200°F (-29°C to +93°C)
Porting	1/4" NPT
Electrical	
Options	SPST-N.O., SPST-N.C. or SPDT
Ratings – pilot duty	20 VA max., 50-250 VAC
Ratings – resistive load	20 W max., 120-240 VAC or VDC
Wires	No. 18 AWG. wire, 24" long, PVC

Calibration

The switches are calibrated on increasing flow in the vertical position on water at 70°F. For other fluids or conditions special calibration is available. In this case, specify orientation, fluid, specific gravity and viscosity.

How to Order

Select model based on switch set-point and material. Special calibration and designs are available.
Reordering? You must supply the Part Number from your instrument label.

Set-point	BRASS PART NUMBERS			STAINLESS STEEL PART NUMBERS		
	SPST N.O.	SPST N.C.	SPDT	SPST N.O.	SPST N.C.	SPDT
0.1 GPM	30101	30141	30121	30201	30241	30221
0.25 GPM	30102	30142	30122	30202	30242	30222
0.5 GPM	30103	30143	30123	30203	30243	30223
0.75 GPM	30104	30144	30124	30204	30244	30224
1.0 GPM	30105	30145	30125	30205	30245	30225
1.5 GPM	30106	30146	30126	30206	30246	30226

Differential Pressure and Flow Electrical Details

Switches, Relays and Transmitters

Features

- Order independently or with dial
- Many safety ratings

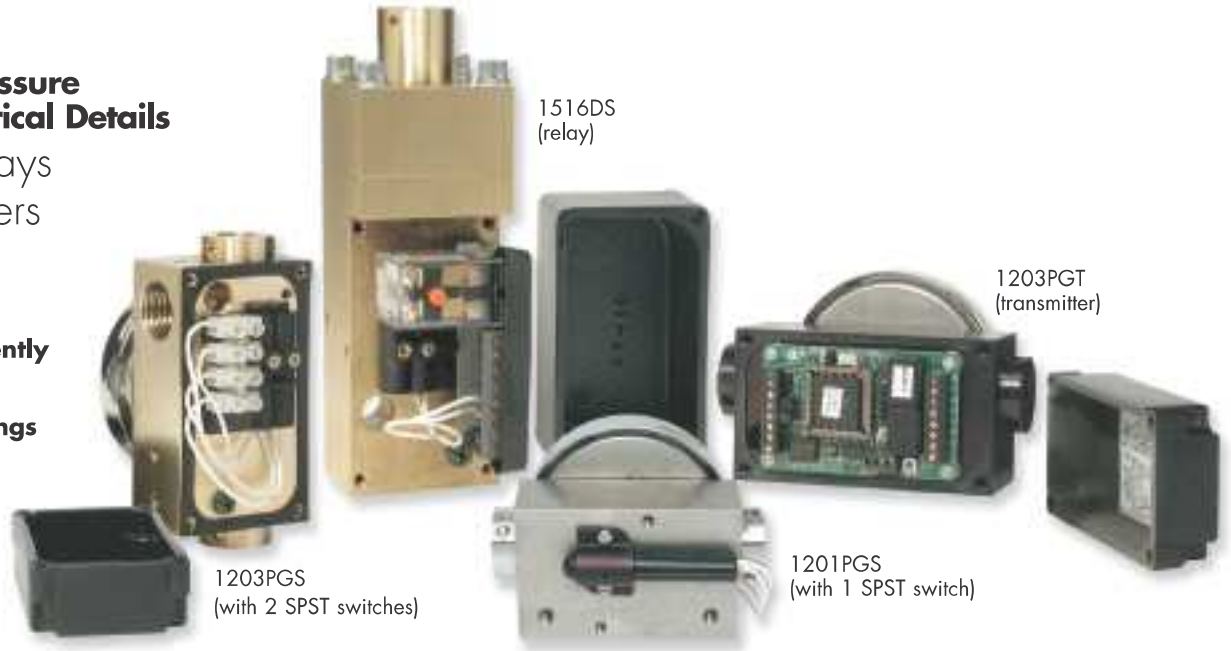

Orange Research differential pressure and flow instruments are available with switches, relays and transmitters to alert the user of process conditions or control process equipment at pre-set values. These electronics are offered independently or in combination with the dials.

Switches:

We offer hermetically sealed reed switches that come with or without enclosures, depending on the model. Choose from SPST, normally open or normally closed, and SPDT switches. The models with enclosures have many safety ratings to satisfy a variety of environments and markets. Select from NEMA-4X to Class 1, Division 1 or 2, or UL, CSA, CE, or ATEX ratings and many more. For complete safety ratings or certifications refer to our individual model Specifications Sheets available for downloading on our website.

Most of our reed switches are field adjustable within the upper 70 or 80% of the full-scale range of the instrument, depending on the model. All switches are preset to the full-scale range unless another value is specified at the time of order placement. When two switches are used they can be set independent of each other. Ask about our High Voltage and High Temperature switches.

Relays:

Our relays are used in high-inductive circuits such as those incorporating solenoids or motors. We use a reed switch to actuate the relay at a prescribed value. This isolates the reed switch, protecting it from high current or voltage. Some models allow for two relays on one instrument.

Transmitters:

Our transmitters incorporate a Hall-effect sensor that transforms the movement of the differential pressure or flow sensor magnet into an electrical output. As conditions change the sensor magnet rotates the pointer (rotary) magnet. This rotation induces a change in output from the Hall-effect sensor that is proportionate to the differential pressure reading or flow rate.

Every transmitter is capable of providing current or voltage output. The user simply selects the output required. Temperature compensation ensures that the output of the transmitter does not drift.

Each transmitter can be installed as a two-wire (loop powered) or as a three- or four-wire connection. Most of the safety ratings of the switch enclosures also apply to the transmitters.

Specifications

Code	Quantity	Type	Ratings (for DC ratings see individual spec. sheets on website)
- A	1	SPST	N.O., 125 VAC, 0.7 A
- A-A	2	SPST	N.O., 125 VAC, 0.7 A
- B	1	SPST	N.C., 120 VAC, 0.2 A
- B-B	2	SPST	N.C., 120 VAC, 0.2 A
- C	1	SPDT	C form, 120 VAC, 0.2 A
- C-C	2	SPDT	C form, 120 VAC, 0.2 A
- R2	Relay	DPDT	10 A contacts, 115 VAC coil (standard)

Relays available for Explosion-Proof Switches

- R1A	1 relay	DPDT	10 A contacts, 115 VAC coil (standard). 240 VAC available, with one common input to coil and contacts
- R1D	2 relays	DPDT	10 A contacts, 115 VAC coil (standard). With two setpoints, separate inputs to coil and contacts

Transmitter

- T2	1 transmitter	Hall Effect	<u>Power:</u> 9-35 VDC @ 100 mA <u>Outputs:</u> 0-5 VDC, 4-20 mA <u>Wiring:</u> 2 wire (loop powered) 3 or 4 wire (voltage output) <u>Operating Temperature:</u> -20°F to 200°F (ambient); temperature compensated output
------	---------------	-------------	---

Note:

Orange Research instruments use long life, hermetically sealed reed switches. Depending on the load, reed switches can be expected to provide between 1-5 million operations at 240 VAC/50 W and 5-10 million operations at 110 VAC/50 W.

To provide maximum life it is recommended that the proper contact protection be applied to reduce or eliminate arcing when switching inductive loads. For example, AC circuits could use a 100 ohm 1/4 W resistor and 0.1 μ f, 600 V capacitor in series across the contacts. For DC circuits use a 1N4004 diode (or equivalent) that is connected cathode-to-positive across the inductive load.

Refer to our website Instruction Sheets for schematics of our electronics.

Our DP & Flow NEMA 4X switch models have a 1/2 inch NPT conduit port as standard. A DIN 43650A-PG11 is optional for standard size models. DIN 43650C-PG7 is optional for Mini DP models. All DIN connector options come with mating connector. Standard size models with DIN connectors are rated IP65 and NEMA 4X while our Mini DP models are IP65 only.



140 Cascade Blvd, Milford CT 06460
Tel: 203-877-5657, Toll Free: 1-800-989-5657
Fax: 203-783-9546, Email: info@orangeresearch.com
Web: www.orangeresearch.com