

Spanners and Wrenches.

Be a MATADOR.



Content Spanners and wrenches.

Page Article group



The Classics.

14	Double Open Ended Spanners
15	Double Open Ended Spanners Sets
16	Combination Spanners, angled
17	Combination Spanners Sets
18	Combination Spanners, offset (MM)
19	Combination Spanners, offset (AF)
19	Combination Spanners Sets
20	Double Ended Ring Spanners
21	Double Ended Ring Spanners Sets



The Troubleshooter.

22	Magnetic Spanners Set
22	Adjustable Single Ended Spanner
23	Adjustable Spanners



The Innovative.

24	Combination Ratchet Spanners, straight
25	Combination Ratchet Spanners Sets
26	Combination Ratchet Spanners, angled
26	Adapters for Ratchet Spanners
27	4in1 Ratchet Spanner



The Sturdy ones.

28	Slogging Open Ended Spanners (MM)
30	Slogging Ring Ended Spanners (MM)
31	Slogging Ring Ended Spanners (AF)
32	Heavy Duty Ring Spanners (MM)
33	Extension Pipes for Heavy Duty

Page Article group



Ring Spanners

The Specials.

34	Half Moon Ring Spanners
35	Double Ended Ring Spanners, straight
35	Double Ended Ring Spanners, TORX [®]
36	Flare Nut Ring Spanners, open
36	Flare Nut Ring Spanners, open
37	Tommy Bar
37	Tubular Box Spanners
38	Hexagon Nut Drivers
38	Hexagon Nut Drivers, flexible
39	Nut Drivers with T-Handle
39	Wheel Nut Wrenches
39	Tommy Bar



MATADOR Spanners. For manual tightening.

Nothing gets done without the good old spanner.



More torque.

To make an accurate and perfectly finished spanner out of a piece of flat steel more than 10 working steps are necessary.

MATADOR processes only high grade, quality-tested Chrome Vanadium steel (31CrV3) that is automatically heated exactly to the right forging temperature.

A precise mechanical processing on state-of-the-art production machines as well as a fully automatic, material-protecting hardening procedure are the basis of the long-lasting quality of our spanners.

Tight spanners tolerances guarantee that the maximum torque can really be applied. And not only the MATADOR Smart Drive profile on the ring side but also precisely grounded heads on the open ended side do not only protect the screw but also ensure that the spanner fits perfectly to the screw.

MATADOR. More torque.
More performance.

Millionfold tried and tested quality.

For more than 110 years MATADOR has been producing several different types of spanners for professional users in industry and craft.

Tightening tools represent our core competence. For screw sizes from 4 up to 230 mm (or 1/4 up to 7.1/2" AF), in metric (mm) or inch (AF) sizes, for fine mechanics and heavy industry – MATADOR surely has the right spanner for your purpose.

Individual sizes made to measure.

Besides our comprehensive range of standardized and non-standardized sizes MATADOR also produces numerous special sizes and types according to your individual specifications – we will be pleased to assist you.



Ring spanners only with SmartDrive.

As one of the first tool manufacturers MATADOR introduced a special flank drive profile („SmartDrive“) for all ring spanners and sockets already more than 10 years ago. For more torque and less wear.

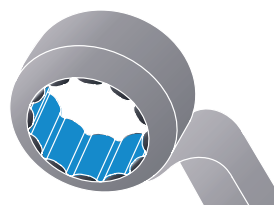

MATADOR's Classics.

Resilient. Accurate. Flat. Durable. Safe. Non-slip.
Non-glare. Simply good.



Good grip through Matt chrome finish.

Thanks to the complex galvanic treatment with nickel and chrome the spanners do not only get an efficient surface protection but also the perfect and well-known MATADOR look.

Matt chrome finished spanners are real and do not hide their inner values below a nice surface.

MATADOR spanners do not only lie better in your hand and have the edge over mirror-finished spanners when working with oil-smearred hands, they also offer great protection against chrome flaking off even under extreme load.

The thin but extremely durable nickel-chrome-coating with non-reflecting effect has proved itself in professional use and is still considered as industrial standard.

Double Open Ended Spanners



- Ideal for tightening hexagon screws and when bolts or cables block the way
- Torque values exceeding DIN standards
- Flat heads for use in confined spaces
- Good grip thanks to matt chrome-plated surface, also with oily hands
- Heads are grinded and polished fully automatically, for longer durability
- Jaws set at 15°

- Standards: DIN 3110 / ISO 3318 / 1085 / 10102
- Material: Chrome Vanadium
- Surface: Matt chrome finish

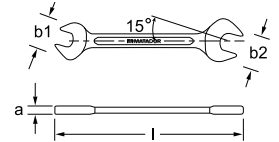

Art. Code	mm	l mm	a mm	b1 mm	b2 mm	g
0100 0405	4 x 5	103	3,2	12,5	14,0	10
0100 0555	5 x 5,5	122	3,2	14,0	16,0	10
0100 5507	5,5 x 7	122	3,3	16,0	17,5	20
0100 0607	6 x 7	122	3,3	16,0	17,5	20
0100 0809	8 x 9	136	3,7	20,0	22,0	25
0100 1011	10 x 11	152	4,5	24,0	27,0	40
0100 1013	10 x 13	172	5,1	26,0	30,5	55
0100 1213	12 x 13	172	5,1	28,5	30,5	70
0100 1415	14 x 15	185	5,5	31,5	33,5	90
0100 1617	16 x 17	201	5,9	35,5	38,5	110
0100 1719	17 x 19	221	6,9	40,0	43,0	155
0100 1819	18 x 19	221	6,9	40,0	43,0	155
0100 1922	19 x 22	235	7,2	44,0	48,0	210
0100 2022	20 x 22	235	7,2	44,0	48,0	210
0100 2123	21 x 23	245	7,4	47,0	51,0	240
0100 2224	22 x 24	245	7,4	47,0	51,0	240
0100 2427	24 x 27	265	8,4	54,0	57,0	320
0100 2528	25 x 28	275	8,4	56,0	61,5	480
0100 2730	27 x 30	275	8,4	56,0	62,5	500
0100 2732	27 x 32	299	9,4	59,5	68,5	530
0100 3032	30 x 32	299	9,4	62,5	68,5	550
0100 3236	32 x 36	325	9,6	68,5	74,5	650
0100 3641	36 x 41	358	9,8	74,5	84,0	830
0100 4146	41 x 46	400	10,3	84,0	93,5	830
0100 4650	46 x 50	450	11,6	95,5	102,0	1500
0100 5560	55 x 60	560	18,0	113,0	123,0	3160



MATADOR's Classics.

Carefully manufactured for generations.
Our classics.

The most important wrenches.

Even though the number of varieties has increased continuously, in the course of the decades four classic spanners have established that may not be missing in any tools assortment:







- Double Open Ended Spanners (DIN 3110)
- Angled Combination Spanners (DIN 3113 A)
- Offset Combination Spanners (DIN 3113 B)
- Double Ended Ring Spanners (DIN 838)



■ Double Open Ended Spanners Sets

- | | | |
|--|--------------|------------------------------------|
| - Tried and tested assortments of double open ended spanners | - Standards: | DIN 3110 / ISO 3318 / 1085 / 10102 |
| - All important sizes in one set | - Material: | Chrome Vanadium |
| - Sets in premium rollbag | - Surface: | Matt chrome finish |
| - Individual assortments on request | | |



		
Art. Code	g	
0100 9080  8 MM	740	1
Content  0100 6 x 7 - 8 x 9 - 10 x 11 - 12 x 13 - 14 x 15 - 16 x 17 - 18 x 19 - 20 x 22 mm		
0100 9120  12 MM	2150	1
Content  0100 6 x 7 - 8 x 9 - 10 x 11 - 12 x 13 - 14 x 15 - 16 x 17 - 18 x 19 - 20 x 22 - 21 x 23 - 24 x 27 - 25 x 28 - 30 x 32 mm		



■ Combination Spanners, angled



- Classic spanners with same sizes on both ends (1 size per spanner)
- With angled ring side
- All-purpose tool for tightening or countering screw joints
- High-grade, durable industrial quality
- Torque values exceeding DIN standards
- Flat heads for use in confined spaces
- Good grip thanks to matt chrome-plated surface, also with oily hands
- Heads are polished fully automatically, for longer durability of spanner and screws

- Jaws set at 15°
- Standards: DIN 3113 A / ISO 3318 / 7738
- Material: Chrome Vanadium
- Surface: Matt chrome finish

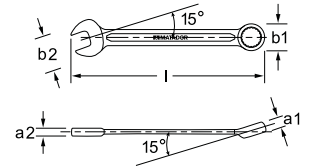

Art. Code	mm	l mm	a1 mm	a2 mm	b1 mm	b2 mm	g	
0185 0060	6	100	5,4	3,6	10,2	15,0	15	10
0185 0070	7	110	5,4	3,6	11,7	16,0	20	10
0185 0080	8	120	6,4	4,1	13,0	18,0	25	10
0185 0090	9	130	6,4	4,1	14,5	20,0	30	10
0185 0100	10	140	7,9	4,6	15,8	22,0	40	10
0185 0110	11	150	8,4	5,1	17,2	24,5	45	10
0185 0120	12	160	8,4	5,1	18,5	27,5	55	10
0185 0130	13	170	9,4	5,9	20,0	28,5	60	10
0185 0140	14	180	9,9	5,9	21,5	30,5	75	10
0185 0150	15	190	9,9	5,9	22,5	32,5	90	10
0185 0160	16	200	10,9	6,3	24,0	34,5	105	10
0185 0170	17	210	10,9	6,5	25,5	37,5	120	10
0185 0180	18	220	11,9	6,7	26,5	39,5	145	10
0185 0190	19	230	11,9	7,2	28,0	42,0	170	10
0185 0200	20	240	12,4	7,7	29,5	43,0	185	10
0185 0210	21	250	12,9	8,2	31,5	45,0	200	10
0185 0220	22	260	12,9	8,7	33,0	47,0	250	10
0185 0240	24	280	13,9	8,9	36,0	51,0	300	10
0185 0270	27	310	15,4	9,7	39,5	57,5	405	5
0185 0300	30	340	16,4	10,2	43,5	60,5	510	5
0185 0320	32	360	16,9	10,2	46,5	65,5	600	5
0185 0340	34	420	19,0	10,2	49,0	72,0	630	5



Art. Code	" AF	l mm	a1 mm	a2 mm	b1 mm	b2 mm	g	
0185 8001	1/4	105	5,6	3,8	10	16,0	20	10
0185 8002	5/16	120	6,8	4,2	13	17,0	30	10
0185 8003	3/8	154	8,0	4,6	16	24,0	50	10
0185 8004	7/16	166	8,6	4,8	17	26,0	60	10
0185 8005	1/2	190	9,8	5,4	20	30,0	80	10
0185 8006	9/16	203	10,4	5,8	22	32,0	100	10
0185 8007	5/8	227	11,6	6,6	25	36,0	135	10
0185 8008	11/16	239	12,2	7	26	38,0	155	10
0185 8009	3/4	230	11,5	7	27,5	42,0	190	10
0185 8010	13/16	250	12,5	8,6	32	46,0	260	10
0185 8011	7/8	300	14,6	9	34	48,0	310	10
0185 8012	15/16	277	13,5	8,5	35	49,0	300	5
0185 8013	1	330	15,6	9,6	38	52,0	380	5
0185 8014	1,1/16	310	15,5	10	39	57,0	470	5
0185 8015	1,1/8	360	17,0	10	43	58,0	470	5
0185 8016	1,1/4	420	20,0	12	48	66,0	775	5

Equally sized Ring Spanners.

Angled or offset?

Ring Spanners are available in two different versions:

Angled (as per DIN 3113 Form A)
or offset (as per DIN 3113 Form B).

Depending on the case of application both versions have their specific advantages and disadvantages.

Angled ring spanners are flatter and shorter than offset ring spanners and are also lower priced.

But especially in case of deep or hardly accessible screw joints offset ring spanners have the edge over the angled form A. They are longer, have a thicker ring head and can thus reach higher torque values so that particularly professional users give their preference to offset type spanners.

Thus MATADOR - as a manufacturer of tools for professional application - has a much larger range of offset type ring spanners than of angled ring spanners.

Further sizes are available on request.

DIN 3113 A



Flatter angle of DIN 3113 A compared to DIN 3113 B

DIN 3113 B

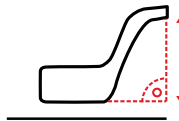

DIN 3113 A



Thinner head of DIN 3113 A compared to DIN 3113 B

DIN 3113 B

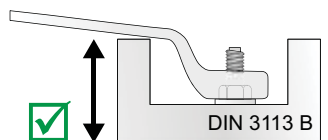
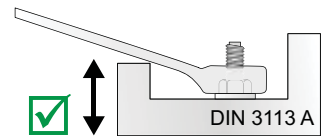
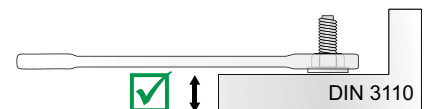
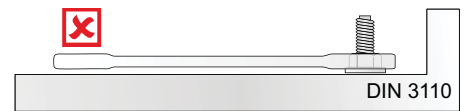
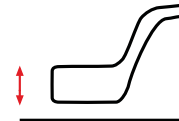

■ Combination Spanners Sets

- Tried and tested assortments of angled combination spanners
- All important sizes in one set
- Sets in premium rollbag
- From 6 to 22 mm or from 6 to 32 mm and from 5/16 to 1" AF in different assortments

- Standards: DIN 3113 A / ISO 3318 / 7738
- Material: Chrome Vanadium
- Surface: Matt chrome finish



Art. Code		g	
0185 9080	8 MM	840	1
Content: 0185 8 - 10 - 11 - 13 - 14 - 17 - 19 - 22 mm			
0185 9100	10 MM	655	1
Content: 0185 6 - 7 - 8 - 9 - 10 - 11 - 13 - 14 - 17 - 19 mm			
0185 9120	12 MM	995	1
Content: 0185 6 - 7 - 8 - 9 - 10 - 11 - 13 - 14 - 17 - 19 - 20 - 22 mm			
0185 9160	16 MM	2670	1
Content: 0185 6 - 7 - 8 - 9 - 10 - 11 - 12 - 13 - 14 - 17 - 19 - 22 - 24 - 27 - 30 - 32 mm			
0185 9170	17 MM	1690	1
Content: 0185 6 - 7 - 8 - 9 - 10 - 11 - 12 - 13 - 14 - 15 - 16 - 17 - 18 - 19 - 20 - 21 - 22 mm			
0185 9121	1/2 AF	1735	1
Content: 0185 5/16 - 3/8 - 7/16 - 1/2 - 9/16 - 5/8 - 11/16 - 3/4 - 13/16 - 7/8 - 15/16 1" AF			



■ Combination Spanners, offset (MM)



- Classic spanners with same sizes on both ends (1 size per spanner)
- With polished and offset ring side
- All-purpose tool for tightening or countering screw joints
- High-grade, durable industrial quality
- Torque values exceeding DIN standards
- Flat heads for confined spaces
- Good grip thanks to matt chrome-plated surface, also with oily hands
- Grinded for longer durability of spanner and screws
- Jaws set at 15°
- Standards: DIN 3113 B / ISO 3318 / 7738
- Material: Chrome Vanadium
- Surface: Matt chrome finish

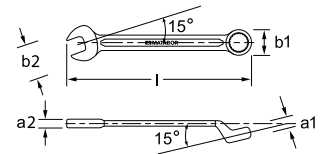

Art. Code	mm	l mm	a1 mm	a2 mm	b1 mm	b2 mm	g
0190 0060	6	100	5,3	3,9	10,0	15,5	20
0190 0070	7	112	5,8	3,9	11,5	16,5	25
0190 0080	8	124	6,3	4,4	13,0	18,5	30
0190 0090	9	136	6,8	4,4	14,5	20,3	35
0190 0100	10	147	7,4	4,9	16,0	22,3	50
0190 0110	11	159	7,8	5,3	17,5	25,3	55
0190 0120	12	171	8,4	5,3	18,2	28,3	65
0190 0130	13	183	9,0	6,2	19,5	29,2	75
0190 0140	14	195	9,8	6,4	21,5	31,0	100
0190 0150	15	207	9,8	6,7	22,5	33,0	105
0190 0160	16	219	10,3	7,1	23,7	35,0	120
0190 0170	17	232	10,4	7,5	25,3	38,0	170
0190 0180	18	243	11,4	7,7	26,8	40,0	155
0190 0190	19	256	11,8	7,9	28,0	41,0	200
0190 0200	20	268	12,0	8,4	29,5	41,5	240
0190 0210	21	279	12,3	8,7	31,5	45,5	250
0190 0220	22	292	12,4	8,9	33,0	48,0	265
0190 0230	23	315	12,8	9,5	35,5	49,5	265
0190 0240	24	315	12,8	9,5	35,5	49,5	400
0190 0250	25	315	12,8	9,5	35,5	49,5	400
0190 0260	26	349	14,3	10,5	39,5	56,5	400
0190 0270	27	349	14,3	10,5	39,5	56,5	485
0190 0280	28	385	15,4	10,9	43,5	63,0	620
0190 0290	29	385	15,4	10,9	43,5	63,0	610
0190 0300	30	385	15,4	10,9	43,5	63,0	610
0190 0320	32	408	16,2	11,1	46,0	67,5	780
0190 0330	33	412	20,5	11,8	47,5	70,5	800
0190 0340	34	412	20,5	11,8	49,0	70,5	840
0190 0360	36	460	23,5	12,8	52,2	76,2	1160
0190 0380	38	460	24,2	13,2	56,0	79,2	1450
0190 0410	41	520	25,5	14,0	60,2	85,0	1120
0190 0460	46	550	27,5	15,0	68,0	95,5	2250
0190 0500	50	580	29,5	16,0	74,0	103,0	2800
0190 0550	55	620	30,5	17,0	82,0	112,5	3600
0190 0600	60	660	32,0	18,0	90,0	121,0	4400
0190 0650	65	710	33,0	22,0	98,0	133,0	4500
0190 0700	70	760	35,0	24,0	105,0	143,0	5600
0190 0750	75	810	38,0	26,0	110,0	153,0	6780
0190 0800	80	860	41,0	28,0	119,0	163,0	8780



■ Combination Spanners, offset (AF)

Art. Code	* AF	l mm	a1 mm	a2 mm	b1 mm	b2 mm	g
0190 8001	1/4	105	5,5	4,3	11,4	16,2	20
0190 8002	5/16	125	6,7	4,7	14,2	20,3	30
0190 8003	3/8	150	7,9	5,1	16,7	24,3	50
0190 8004	7/16	160	8,5	5,3	17,9	26,4	55
0190 8005	1/2	185	9,7	5,9	20,7	30,5	75
0190 8006	9/16	195	10,2	6,3	22,3	32,5	90
0190 8007	19/32	195	10,8	6,7	23,6	34,5	105
0190 8008	5/8	220	11,4	7,1	25,1	36,5	120
0190 8009	11/16	250	12,0	7,5	26,6	38,5	135
0190 8010	3/4	255	12,8	8,3	29,5	42,5	200
0190 8011	13/16	280	12,5	9,1	31,0	45,0	240
0190 8012	7/8	290	14,4	9,4	34,5	48,7	265
0190 8013	15/16	295	14,4	9,4	34,5	48,7	365
0190 8014	1	329	15,4	9,8	38,0	52,7	400
0190 8015	1,1/16	350	16,7	10,6	40,5	56,0	485
0190 8016	1,1/8	360	16,7	10,6	41,8	59,0	485
0190 8017	1,1/4	410	16,7	11,0	46,0	67,0	780
0190 8018	1,5/16	435	20,5	12,2	48,5	70,5	780
0190 8019	1,3/8	460	21,2	13,0	53,8	76,0	1000
0190 8020	1,7/16	460	21,2	13,0	53,8	76,0	1000
0190 8021	1,1/2	460	24,2	13,2	56,0	79,2	1400
0190 8022	1,5/8	520	25,5	14,0	60,5	85,0	1400
0190 8023	1,11/16	470	22,0	13,5	62,0	85,0	1400
0190 8024	1,3/4	550	27,5	15,0	66,0	95,5	2200
0190 8025	1,13/16	550	27,5	15,0	68,0	95,5	2250
0190 8026	1,7/8	550	27,5	15,0	69,0	95,5	2300
0190 8027	2	580	29,5	16,0	74,5	103,0	2800



■ Combination Spanners Sets

- Tried and tested assortments of offset type combination spanners
- Standards: DIN 3113 B / ISO 3318 / 7738
- All important sizes in one set
- Material: Chrome Vanadium
- Sets in premium rollbag
- Surface: Matt chrome finish

Art. Code	g
0190 9080 8 MM	600
Content 0190 8 - 9 - 10 - 11 - 13 - 14 - 17 - 19 mm	1
0190 9120 12 MM	1175
Content 0190 8 - 9 - 10 - 11 - 12 - 13 - 14 - 15 - 16 - 17 - 18 - 19 mm	1
0190 9121 12 MM	1300
Content 0190 6 - 7 - 8 - 9 - 10 - 11 - 12 - 13 - 14 - 17 - 19 - 22 mm	1
0190 9122 12 MM	3200
Content 0190 10 - 11 - 12 - 13 - 14 - 17 - 19 - 22 - 24 - 27 - 30 - 32 mm	1
0190 9160 16 MM	3220
Content 0190 6 - 7 - 8 - 9 - 10 - 11 - 12 - 13 - 14 - 17 - 19 - 22 - 24 - 27 - 30 - 32 mm	1
0190 9170 17 MM	1920
Content 0190 6 - 7 - 8 - 9 - 10 - 11 - 12 - 13 - 14 - 15 - 16 - 17 - 18 - 19 - 20 - 21 - 22 mm	1
0190 9260 26 MM	4500
Content 0190 6 - 7 - 8 - 9 - 10 - 11 - 12 - 13 - 14 - 15 - 16 - 17 - 18 - 19 - 20 - 21 - 22 - 23 - 24 - 25 - 26 - 27 - 28 - 29 - 30 - 32 mm	1
0190 9161 16 AF	3365
Content 0190 1/4 - 5/16 - 3/8 - 7/16 - 1/2 - 9/16 - 19/32 - 5/8 - 11/16 - 3/4 - 13/16 - 7/8 - 15/16 1 - 1.1/16 - 1.1/4 , AF	1



Double Ended Ring Spanners



- Classic spanners with deeply offset double ring profile for deep-set screw joints
 - 2 sizes per spanner
 - High-grade, durable industrial quality
 - Good grip thanks to matt chrome-plated surface, also with oily hands
 - Heads fully automatically grinded, for longer durability of spanner and screws
- Standards: DIN 838 / ISO 3318 / 1085 / 10104
 - Material: Chrome Vanadium
 - Surface: Matt chrome finish

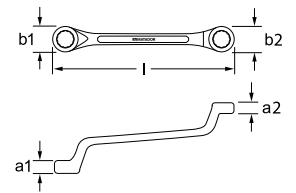

Art. Code	mm	l mm	a1 mm	a2 mm	b1 mm	b2 mm	g		
0200 0607	6 x 7	167	5,6	6,2	10,4	12,0	40	10	
0200 0809	8 x 9	182	6,4	7,1	13,4	15,0	60	10	
0200 0810	8 x 10	182	6,4	7,1	13,4	16,0	60	10	
0200 1011	10 x 11	197	7,5	8,0	16,0	17,8	75	10	
0200 1013	10 x 13	216	8,5	9,1	16,0	21,0	110	10	
0200 1213	12 x 13	216	8,5	9,1	19,3	21,0	110	10	
0200 1317	13 x 17	263	10,3	10,7	22,0	26,5	240	10	
0200 1415	14 x 15	216	9,7	10,7	21,8	22,7	110	10	
0200 1617	16 x 17	263	10,3	10,7	25,0	26,5	240	10	
0200 1719	17 x 19	290	11,0	11,3	27,5	29,0	300	10	
0200 1819	18 x 19	290	11,0	11,3	27,5	29,0	300	10	
0200 1922	19 x 22	318	11,7	12,4	29,0	33,5	305	10	
0200 2022	20 x 22	318	11,7	12,4	29,0	33,5	305	10	
0200 2123	21 x 23	325	12,2	13,0	32,0	35,0	360	5	
0200 2224	22 x 24	325	12,2	13,0	34,0	37,0	360	5	
0200 2426	24 x 26	337	13,0	14,0	36,1	40,0	430	5	
0200 2427	24 x 27	337	13,0	14,0	36,1	40,0	430	5	
0200 2528	25 x 28	346	13,2	14,5	38,0	42,0	450	5	
0200 3032	30 x 32	360	15,2	16,5	43,7	46,0	620	5	
0200 3236	32 x 36	410	16,0	17,5	50,0	52,0	950	5	
0200 3641	36 x 41	440	17,5	19,0	52,0	60,0	1 100	5	
0200 4146	41 x 46	475	19,5	21,0	60,0	67,0	1 280	5	
0200 4650	46 x 50	536	19,7	20,6	61,0	68,0	1 390	1	
0200 5560	55 x 60	610	24,6	25,6	84,9	91,8	3 150	1	



Art. Code	" AF	l mm	a1 mm	a2 mm	b1 mm	b2 mm	g		
0200 8001	1/4 x 5/16	176	5,8	6,4	12,0	14,5	55	10	
0200 8002	3/8 x 7/16	206	8,5	9,0	16,0	17,2	115	10	
0200 8003	7/16 x 1/2	221	9,5	9,8	18,7	20,0	135	10	
0200 8004	1/2 x 9/16	245	9,5	10,2	21,7	23,5	145	10	
0200 8005	5/8 x 11/16	271	12,0	12,8	26,0	29,0	270	5	
0200 8006	3/4 x 25/32	271	12,4	12,8	27,5	29,0	270	5	
0200 8007	13/16 x 7/8	311	13,6	14,2	32,0	35,0	400	5	
0200 8008	15/16 x 1	331	14,4	15,0	36,5	39,5	495	5	
0200 8009	1,1/16 x 1,1/4	371	15,4	17,0	40,7	47,5	640	5	

MATADOR SmartDrive. The intelligent profile.

Goes easy on the tool and the screw.

Conventional „angular” hexagon or double hexagon profiles transfer considerable tightening and separation forces to the edges of the screw heads.

The consequences:

- Lower traction
- Deformed screw heads
- Less contact surface when screw heads are rounded

As one of the first tool manufacturers MATADOR introduced a special flank drive profile („SmartDrive”) for all ring spanners and sockets already more than 10 years ago.

Spanners with MATADOR Smart-Drive profile transfer forces to the flanks of the screw head, not to the edges. Thanks to this flank drive profile the spanners can work on double the contact surface than conventional spanners.

The advantages:

- Optimized traction, even on screws with rounded edges
- Higher torque values
- Ideal protection of the screws and nuts

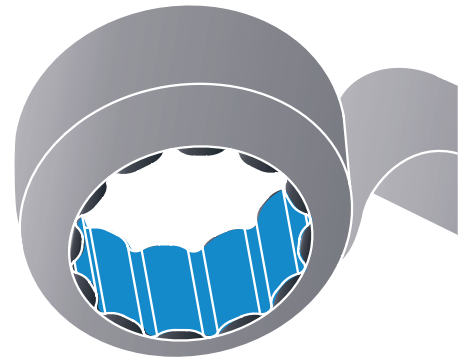

Conventional profile:

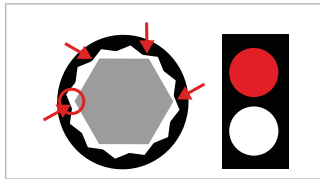

Less traction with angular double hexagon profiles

Conventional profile:

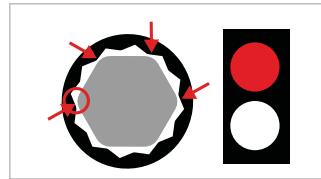

Hardly any traction on screws with rounded edges

MATADOR SmartDrive:

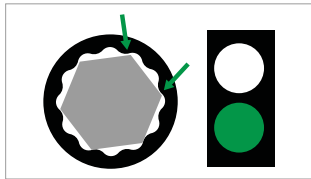

Perfect traction also on screws with rounded edges



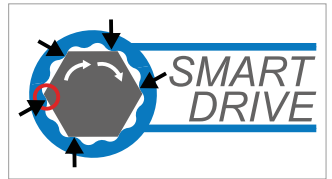





MATADOR SmartDrive:



■ Double Ended Ring Spanners Sets

- Tried and tested assortments of ring spanners, all important sizes in one set
 - High-grade, durable industrial quality
 - Good grip thanks to matt chrome-plated surface, also with oily hands
 - Fully automatically grinded heads, for longer durability of spanner and screws
 - Sets in premium rollbag
 - Individual assortments on request
- Standards: DIN 838 / ISO 3318 / 1085 / 10104
 - Material: Chrome Vanadium
 - Surface: Matt chrome finish



Art. Code	g	
0200 9080  8 MM	1265	1
Content  0200 6 x 7 - 8 x 9 - 10 x 11 - 12 x 13 - 14 x 15 - 16 x 17 - 18 x 19 - 20 x 22 mm		
0200 9100  10 MM	2355	1
Content  0200 6 x 7 - 8 x 9 - 10 x 11 - 12 x 13 - 14 x 15 - 16 x 17 - 18 x 19 - 20 x 22 - 24 x 27 - 30 x 32 mm		
0200 9120  12 MM	3310	1
Content  0200 6 x 7 - 8 x 9 - 10 x 11 - 12 x 13 - 14 x 15 - 16 x 17 - 18 x 19 - 20 x 22 - 21 x 23 - 24 x 27 - 25 x 28 - 30 x 32 mm		
0200 9081  8 AF	2180	1
Content  0200 1/4 x 5/16 - 3/8 x 7/16 - 1/2 x 9/16 - 5/8 x 11/16 - 3/4 x 25/32 - 13/16 x 7/8 - 15/16 x 1 - 1,1/16 x 1,1/4 , AF		

■ Magnetic Spanners Set



- For fine mechanics, model making etc.
- 10 mini tools on ring, consisting of 8 mini open ended spanners, 1 contact file with slotted screwdriver, 1 feeler gauge 0.40 mm

- Material: Sheet steel, hardened
- Surface: Nickel-plated

Art. Code	g	
0158 0001 10 MM	50	1
Content 0145 4 - 4,5 - 5 - 5,5 - 6 - 6,5 - 7 - 7,5 mm		



The right spanner for screw and nut.

The width across flats (SW) of a spanner defines the „size“ of the spanner, e.g. SW 13 for 13 mm. The mm and inch units are stamped into the spanner.

Screws and nuts are classified through the nominal diameter (d) of their thread and thus identified e.g. as „M 6“.

Thread diameter and width of the spanner are not identical. The correct spanner-screw combination can be seen from the alongside table:



Spanner sizes for hexagon nuts and screws are defined as per DIN ISO 272. E.g. according to this standard a nut sized M 8 requires a spanner sized 13 mm.

According to the previously valid DIN 931 and 933 the required spanner size for M 10 screws was 17 mm and 19 mm for M 12 screws.

Due to the transformation of the DIN into the international ISO standard the correct spanner sizes became 16 and 18 mm leading to an increased importance of spanners sized 16 and 18 mm.

	M 2	M 2,5	M 3	M 4	M 5	M 6	M 8
	SW 4	SW 5	SW 5,5	SW 7	SW 8	SW 10	SW 13
	M 10	M 12	M 14	M 16	M 18	M 20	M 22
	SW 16 (SW 17)	SW 18 (SW 19)	SW 22	SW 24	SW 27	SW 30	SW 32

Values in brackets = old values are the previously applicable DIN 931 / 933

■ Adjustable Single Ended Spanner



- Individual versatile single ended spanner, thanks to its continuous setting
- Wide range: 6 - 24 mm
- Good grip thanks to knurly spool
- With ergonomic non-slip rubber handle
- With practical hole for hooks

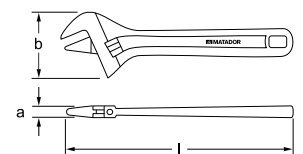

Art. Code	mm	" AF	l "	l mm	a mm	b mm	mm	g	
0590 0080	6-24	0-1	8	200	13,5	57	0-25	250	1

Adjustable Single Ended Spanners. One for all.

The practical allround spanner.

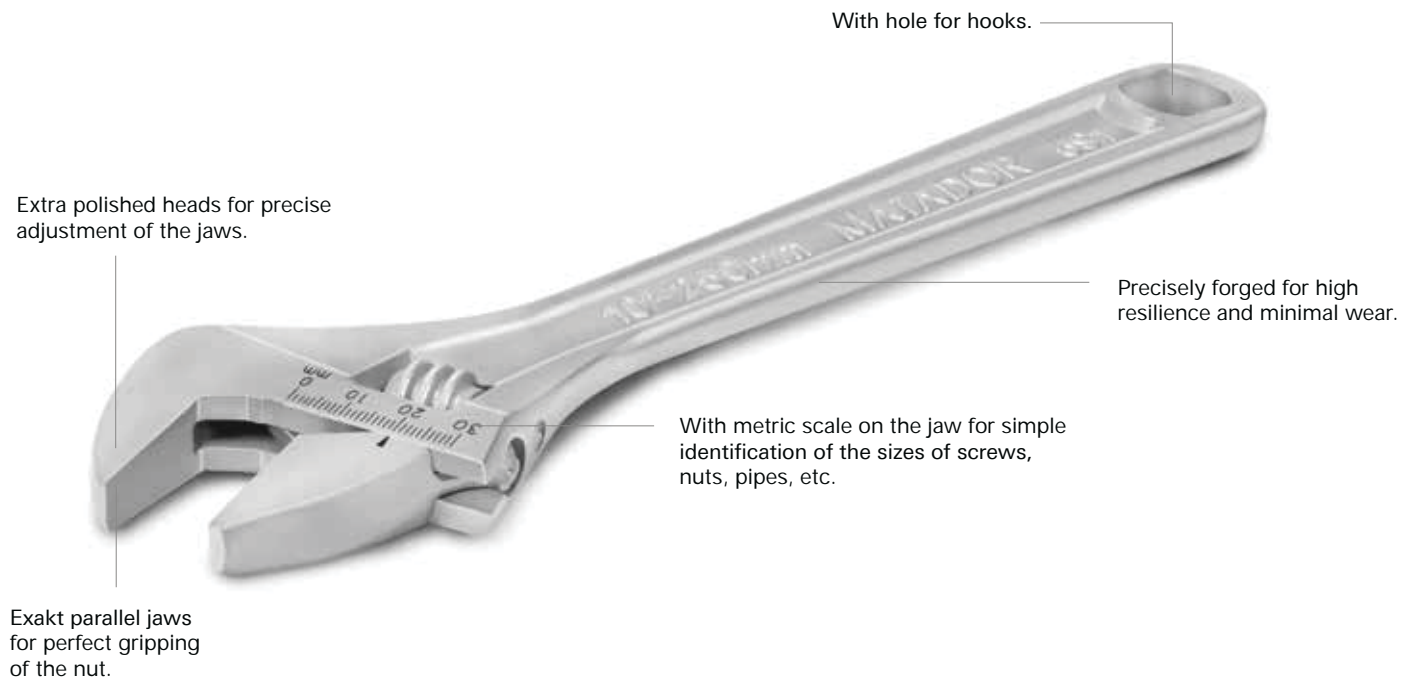

Adjustable Spanners

- Several sizes per spanner
- High-grade, durable industrial quality
- Good grip thanks to matt chrome-plated surface, also with oily hands
- Swedish type with anticlockwise spool
- Jaws set at 15°
- Standards: DIN 3117 Form A ISO 6787-1982

- Material: Chrome Vanadium (6 - 12")
Tempered steel (15 - 18")
- Surface: Matt chrome finish

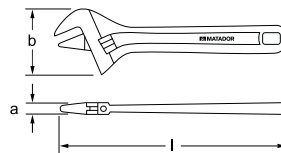

Art. Code	mm	*AF	l"	l mm	a mm	b mm	mm	g	
0591 0040	0-13	0-1/2	4	100	12.5	46	0-13	140	1
0591 0060	0-20	0-25/32	6	150	12.5	46	0-20	140	1
0591 0080	0-25	0-1	8	200	13.5	57	0-25	250	1
0591 0100	0-30	0-1.3/16	10	250	16	66	0-30	390	1
0591 0120	0-40	0-1.9/16	12	300	20	82	0-40	630	1
0591 0150	0-43	0-1.11/16	15	375	25	105	0-45	950	1



MATADOR Ratchet Spanners. If time is short.

The most important innovation since the invention of spanners.



Made of CHROME VANADIUM Steel for high resilience and minimal wear.

Exceeds the torque values of standard combination spanners.

With 72 teeth.

With patented GEARplus[®] technique.



2 in 1: Ratchet Spanners.

MATADOR Ratchet Spanners combine the advantages of a ratchet with those of a slim spanner:

The ultra slim design of the ring side allows fast working in confined spaces, even where conventional ratchets with sockets are not applicable. For instance the thickness of the ring side of a ratchet spanner is only 1/5 of the height of a standard ratchet with socket.

The open ended side is appropriate for all screw connections where bolts or cables block the way.

Higher torque value in most confined spaces.

MATADOR relies on the tried and tested GEARplus[®] technique which is made of specially hardened and Tempered steel.

The progressive toothing of the inserted ratchet gear allows the transmission of up to 30% more torque compared to previous ratchet spanners and reaches and even exceeds the DIN / ISO torque standards for standard combination spanners.

Thanks to the ratcheting angle of only 5° and the 72 teeth ratchet mechanism screw connections can be tightened or loosened at a previously unknown speed – without resetting.

With MATADOR SmartDrive profile.

Of course, all MATADOR ratchet spanners are provided with MATADOR SmartDrive profile.

MATADOR SmartDrive profile transmits forces at 100% to the flanks of the screw head or the nut, not to the edges. Thanks to this flank drive profile the spanners work on double the contact surface than conventional spanners, even rounded screws are no problem.

The advantages:

- Optimized traction, even on screws with rounded edges
- Higher torque values
- Ideal protection of the screws and nuts

What are the benefits of ratchet spanners?

One can no longer imagine a modern workshop without ratchet spanners.

Meanwhile millionfold tried and tested ratchet spanners often replace the use of standard ratchets and spanners. Through the flat design they reach spaces where standard reversible ratchets with sockets cannot be used.

Thanks to the innovative ratchet technique screws can be tightened up to 7x faster because there is no need for resetting the tool.

And by the way ratchet spanners reach nearly identical torque values compared to standard spanners.

Powerful, flat, fast.

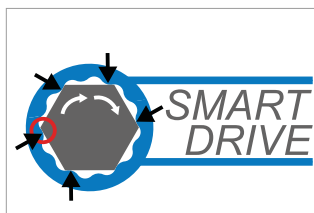
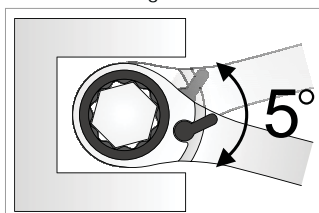
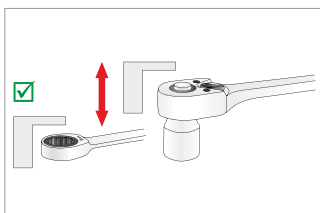



■ Combination Ratchet Spanners, straight

- Combination ratchet spanners, straight type
- With 72 teeth, very high torque values (exceeding DIN 3110 / ISO 3318)
- With patented ratchet gear (GEARplus[®]) made of special steel with 72 teeth
- Simply turn around for clockwise / anticlockwise use
- Jaws set at 15°
- Standards: Similar to DIN 3113 A, ISO 3318 / 7738
- Material: Chrome Vanadium
- Surface: Matt chrome finish

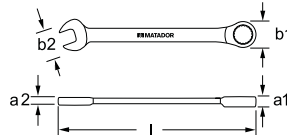

Art. Code	mm	l mm	a1 mm	a2 mm	b1 mm	b2 mm	g
0183 0060	6	128	6,3	3,9	14,0	15,0	25
0183 0070	7	140	6,5	4,0	16,8	16,7	30
0183 0080	8	140	6,5	4,0	16,8	16,7	30
0183 0090	9	149	6,9	4,4	18,8	18,7	40
0183 0100	10	158	7,3	4,8	20,8	20,8	50
0183 0110	11	165	7,7	5,2	21,8	23,0	60
0183 0120	12	171	8,2	5,5	22,8	24,6	70
0183 0130	13	178	8,6	5,8	24,8	26,8	80
0183 0140	14	190	9,0	6,2	27,8	29,0	110
0183 0150	15	199	9,4	6,5	28,8	31,0	120
0183 0160	16	208	9,9	6,8	30,8	33,0	150
0183 0170	17	225	10,3	7,2	31,8	35,5	180
0183 0180	18	236	10,7	7,7	32,8	37,5	210
0183 0190	19	247	11,2	8,2	33,8	39,4	240
0183 0220	22	289	13,0	9,0	40,0	45,8	340
0183 0240	24	322	14,5	10,0	46,0	51,8	470
0183 0270	27	358	15,5	10,5	52,0	56,4	580
0183 0300	30	401	17,0	11,4	58,0	62,7	860
0183 0320	32	424	17,5	12,5	62,0	66,4	1060



■ Combination Ratchet Spanners Sets

- Tried and tested assortments of combination ratchet spanners, straight type
- All important sizes in one set

Art. Code	g
0183 9050 5 MM	600 1
Content: 0183 8 - 10 - 13 - 17 - 19 mm	
0183 9080 8 MM	790 1
Content: 0183 8 - 9 - 10 - 11 - 13 - 14 - 17 - 19 mm	
0183 9120 12 MM	1400 1
Content: 0183 8 - 9 - 10 - 11 - 12 - 13 - 14 - 15 - 16 - 17 - 18 - 19 mm	
0189 9050 5 MM	600 1
Content: 0183 8 - 10 - 13 - 17 - 19 mm	
0189 9080 8 MM	790 1
Content: 0183 8 - 9 - 10 - 11 - 13 - 14 - 17 - 19 mm	
0189 9120 12 MM	1400 1
Content: 0183 8 - 9 - 10 - 11 - 12 - 13 - 14 - 15 - 16 - 17 - 18 - 19 mm	



■ Combination Ratchet Spanners, angled



- Combination ratchet spanners, angled type, jaws set at 15°
- With 72 teeth, very high torque values (exceeding DIN 3110 / ISO 3318)
- With patented ratchet gear (GEARplus®) made of special steel with 72 teeth
- With switch lever
- Standards: Similar to DIN 3113 A / ISO 3318 / 7738

- Material: Chrome Vanadium
- Surface: Matt chrome finish

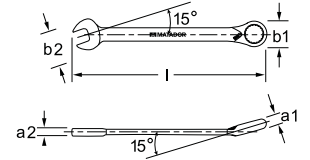

Art. Code	mm	l mm	a1 mm	a2 mm	b1 mm	b2 mm	g	
0189 0060	6	126	6,3	3,9	14,0	15,0	30	10
0189 0070	7	145	6,5	4,6	16,6	16,7	30	10
0189 0080	8	145	6,5	4,6	16,6	16,7	30	10
0189 0090	9	150	6,9	4,9	18,4	18,8	40	10
0189 0100	10	145	7,3	5,3	20,0	20,8	50	10
0189 0110	11	165	7,7	5,6	21,8	23,0	60	10
0189 0120	12	172	8,2	6,0	22,7	25,0	70	10
0189 0130	13	165	8,6	6,4	24,7	27,1	80	10
0189 0140	14	190	9,0	6,8	27,0	29,2	100	10
0189 0150	15	200	9,4	7,0	28,3	31,3	120	10
0189 0160	16	208	9,9	7,2	30,0	33,4	150	10
0189 0170	17	225	10,3	7,7	31,8	35,5	160	10
0189 0180	18	237	10,7	8,2	32,6	37,6	190	10
0189 0190	19	248	11,2	8,8	33,8	39,7	220	10
0189 0220	22	290	13,0	9,0	40,0	46,0	360	5
0189 0240	24	323	14,5	10,0	46,0	52,2	470	5
0189 0270	27	331	15,5	10,5	52,5	56,5	660	5
0189 0300	30	389	17,0	11,4	58,5	62,7	860	5
0189 0320	32	415	17,5	12,4	62,6	66,4	1050	5

■ Adapters for Ratchet Spanners



- Makes an ultra-flat ratchet out of a ratchet spanner (10 mm = 1/4" or 1/4" Bit, 13 mm = 3/8" and 19 mm = 1/2")
- With push-button quick-release function
- Applicable for ratchet spanners with GEARplus® technique

- Standards: DIN 3120 / ISO 1174 DIN 3126 / C 6,3
- Material: Chrome Vanadium
- Surface: Polished chrome finish

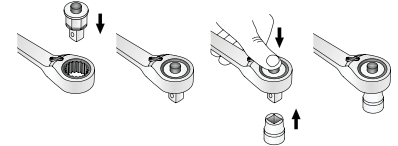
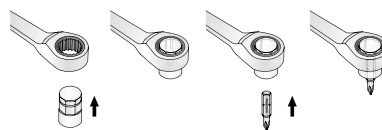
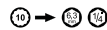

Art. Code	g	
0186 0010	60	1
Content	0186 6,3 (1/4) Bit - 6,3 (1/4) - 10 (3/8) - 12,5 (1/2) mm	

4in1 Ratchet Spanner.

Suitable for 70% of all screw tasks.

Ideal for mobile use.



70% is more than two thirds.

MATADOR's „4in1“ ratchet spanner must not be missing in any modern tools assortment.

70% of all screws and nuts need a spanner size of 10, 13, 17 or 19 mm - and this is exactly what the „4in1“ ratchet spanner provides. Especially in cases when a complete spanner set is not at hand (e.g. during mobile use) 70% of all possible screw tasks (thus more than two thirds!) can be solved only with this single spanner - with torque values exceeding those of a standard spanner.

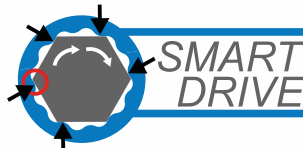

4in1 Ratchet Spanner

- 4 ratchet spanners in one tool, combines 10, 13, 17 and 19 mm
- For 70% of all screw tasks
- With patented ratchet gear ("Reverse Gear") made of special steel with 120 teeth
- Transmits very high torque values
 - Size 10 x 13 = max. 138 Nm
 - Size 17 x 19 = max. 387 Nm

- Only 3° ratcheting angle thanks to 120 teeth - especially suitable for confined spaces
- Material: Chrome Vanadium
- Surface: Matt chrome finish

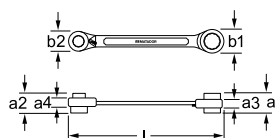

Art. Code	mm	l mm	a1/a3 mm	a2/a4 mm	b1 mm	b2 mm	g	
0184 0001	10,13,17,19	190	21,9 / 11,2	17,1 / 9,0	33,6	21,9	196	1



MATADOR Slogging Spanners.

Rise to the challenge.



■ Slogging Open Ended Spanners (MM)



- Tried and tested MATADOR classic
 - For tightening and loosening of big screw joints, e.g. in heavy industry, shipbuilding, plant construction, etc.
 - Ideal for the use with club hammer or air hammer
 - Precisely drop-forged
 - Very high impact strength
 - Up to 500 mm made of Chrome Vanadium steel 31 CrV 3, from 525 mm made of C 35
 - With zinc-plated surface for durable rust protection - not only sandblasted / oiled
- Standards: DIN 133 (except for special sizes *)
 - Material: 31 CrV 3 / C 35
 - Surface treatment: Zinc-plated

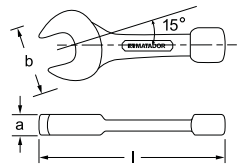

Art. Code	mm	l mm	a mm	b mm	g
0175 0220	22*	180	16,0	55,0	280
0175 0240	24*	180	16,0	55,0	280
0175 0260	26*	180	16,0	57,0	210
0175 0270	27	180	16,5	57,5	385
0175 0280	28*	180	16,0	57,0	280
0175 0300	30	190	17,0	63,5	451
0175 0320	32	195	17,5	66,5	552
0175 0340	34	195	17,5	66,5	559
0175 0350	35*	215	19,0	76,0	745
0175 0360	36	210	18,5	75,5	709
0175 0370	37*	215	19,0	76,0	740
0175 0380	38*	215	19,0	76,0	680
0175 0400	40*	235	19,0	86,0	900
0175 0410	41	225	19,5	88,0	1000
0175 0420	42*	235	19,0	86,0	900
0175 0450	45*	255	20,0	98,0	1200
0175 0460	46	255	20,0	98,0	1258
0175 0470	47*	255	20,0	98,0	1200

Art. Code	mm	l mm	a mm	b mm	g
0175 0480	48*	255	20,0	98,0	1275
0175 0500	50	280	21,5	108,0	1609
0175 0520	52*	275	21,0	105,0	1450
0175 0550	55	310	24,0	118,5	2131
0175 0560	56*	300	23,0	116,0	1900
0175 0600	60	320	24,5	129,5	2484
0175 0640	64*	345	27,0	138,0	3300
0175 0650	65	342	28,0	140,5	3340
0175 0700	70	370	30,0	151,0	4325
0175 0750	75	400	31,5	163,0	5110
0175 0800	80	405	34,5	174,0	6020
0175 0850	85	405	34,5	174,0	5770
0175 0900	90	455	39,0	195,0	8905
0175 0950	95	455	39,0	195,0	8985
0175 1000	100	500	47,0	227,0	13315
0175 1050	105	500	47,0	227,0	13220
0175 1100	110	500	47,0	227,0	13045
0175 1150	115	525	55,0	246,5	17660

Art. Code	mm	l mm	a mm	b mm	g	
0175 1200	120	525	55,0	246,5	17610	1
0175 1250	125*	545	50,0	255,0	16760	1
0175 1300	130	575	55,0	275,0	19030	1
0175 1350	135	575	55,0	275,0	18880	1
0175 1400	140*	575	55,0	275,0	17880	1
0175 1450	145	640	60,0	305,0	26665	1
0175 1500	150	640	60,0	305,0	24660	1
0175 1550	155	640	60,0	305,0	24200	1
0175 1600	160*	640	60,0	305,0	25690	1
0175 1650	165	715	70,0	342,0	39560	1
0175 1700	170	715	70,0	342,0	37760	1
0175 1750	175*	715	70,0	342,0	36840	1
0175 1800	180*	715	70,0	392,0	37000	1
0175 1850	185*	715	70,0	392,0	36000	1
0175 1900	190*	800	78,0	392,0	53300	1
0175 1950	195*	800	78,0	392,0	52900	1
0175 2000	200*	800	78,0	392,0	52500	1
0175 2050	205*	800	78,0	392,0	52500	1
0175 2100	210*	800	78,0	392,0	51700	1
0175 2150	215*	800	78,0	392,0	51300	1
0175 2200	220*	800	72,0	415,0	51300	1

* Made to order, no general stock size

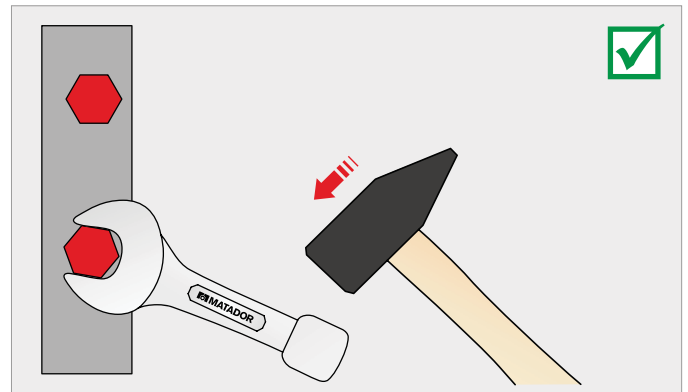

MATADOR Slogging Spanners.

Rise to the challenge.



■ Slogging Ring Ended Spanners (MM)



- Tried and tested MATADOR classic
 - For tightening and loosening of big screw joints, e.g. in heavy industry, shipbuilding, plant construction, etc.
 - Ideal for the use with club hammer or air hammer
 - Precisely drop-forged
 - Very high impact strength
 - Up to 435 mm made of Chrome Vanadium steel 31 CrV 3, from 480 mm made of C 35
 - With zinc-plated surface for durable rust protection - not only sandblasted / oiled
- Standards: DIN 7444 (except for special sizes *)
 - Material: 31 CrV 3 / C 35
 - Surface treatment: Zinc-plated

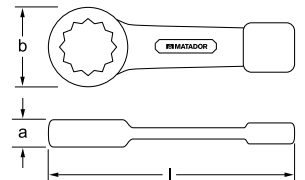

Art. Code	mm	l mm	a mm	b mm	g	
0270 0220	22*	165	15,0	43,0	220	1
0270 0240	24*	160	15,0	42,5	250	1
0270 0270	27	180	15,5	47,0	350	1
0270 0300	30	190	16,5	52,5	400	1
0270 0320	32	195	16,5	54,0	450	1
0270 0340	34	195	16,5	54,0	600	1
0270 0360	36	205	19,5	60,0	750	1
0270 0380	38*	205	19,5	60,0	660	1
0270 0410	41	225	20,5	66,0	850	1
0270 0460	46	240	22,5	75,0	1050	1
0270 0500	50	250	23,5	80,0	1250	1
0270 0550	55	270	25,0	87,5	1550	1
0270 0560	56*	270	25,0	86,0	1400	1
0270 0600	60	270	26,0	93,5	1650	1
0270 0650	65	290	29,0	101,0	2300	1
0270 0700	70	320	32,5	109,5	2600	1
0270 0750	75	325	34,0	114,5	3350	1

Art. Code	mm	l mm	a mm	b mm	g	
0270 0800	80	345	35,0	123,0	3800	1
0270 0850	85	360	37,0	129,0	4200	1
0270 0900	90	400	41,5	152,0	5700	1
0270 0950	95	400	41,5	152,0	5700	1
0270 1000	100	400	41,5	152,0	5700	1
0270 1050	105	435	47,5	172,0	8500	1
0270 1100	110	435	47,5	172,0	8500	1
0270 1150	115	435	47,5	172,0	8500	1
0270 1200	120	480	54,0	182,0	10000	1
0270 1250	125*	480	54,0	182,0	10000	1
0270 1300	130	520	58,0	202,0	13000	1
0270 1350	135	520	58,0	202,0	13000	1
0270 1400	140*	520	58,0	202,0	13000	1
0270 1450	145	580	64,0	228,0	18000	1
0270 1500	150	580	64,0	228,0	18000	1
0270 1550	155	580	64,0	228,0	18000	1
0270 1600	160*	580	64,0	228,0	18000	1

Art. Code	mm	l mm	a mm	b mm	g	
0270 1650	165	650	70,0	265,0	25000	1
0270 1700	170	650	70,0	265,0	25000	1
0270 1750	175*	650	70,0	265,0	25000	1
0270 1800	180*	650	70,0	265,0	24600	1
0270 1850	185*	700	75,0	290,0	33000	1
0270 1900	190*	700	75,0	290,0	32600	1
0270 1950	195*	700	75,0	290,0	31800	1
0270 2000	200*	700	75,0	290,0	32000	1
0270 2050	205*	750	80,0	320,0	40500	1
0270 2100	210*	750	80,0	320,0	39500	1
0270 2150	215*	750	80,0	320,0	39000	1
0270 2200	220*	750	80,0	320,0	37400	1
0270 2250	225*	750	80,0	320,0	36400	1
0270 2300	230*	750	80,0	320,0	35400	1

* Made to order, no general stock size

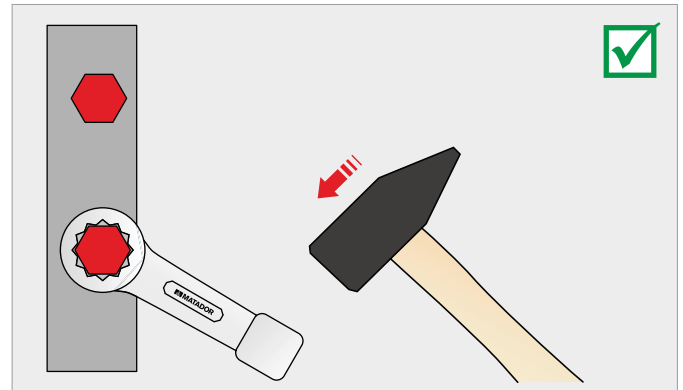

■ Slogging Ring Ended Spanners (AF)

- Tried and tested MATADOR classic
 - For tightening and loosening of big screw joints, e.g. in heavy industry, shipbuilding, plant construction, etc.
 - Ideal for the use with club hammer or air hammer
 - Precisely drop-forged
 - Very high impact strength
 - Up to 435 mm made of Chrome Vanadium steel 31 CrV 3, from 480 mm made of C 35
 - With zinc-plated surface for durable rust protection - not only sandblasted / oiled
- Standards: DIN 7444 (except for special sizes *)
 - Material: 31 CrV 3 / C 35
 - Surface treatment: Zinc-plated

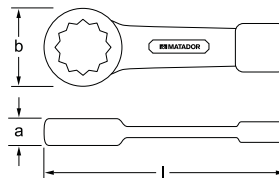

Art. Code	* AF	l mm	a mm	b mm	g	
0270 8002	1*	160	15,0	42,5	1640	1
0270 8003	1.1/16*	185	15,5	48,5	1650	1
0270 8004	1.1/8*	185	15,5	48,5	1640	1
0270 8005	1.3/16*	190	16,5	52,5	1640	1
0270 8006	1.1/4*	190	16,5	52,5	1640	1
0270 8007	1.5/16*	195	16,5	54,0	2150	1
0270 8008	1.3/8*	195	16,5	54,0	2300	1
0270 8009	1.7/16*	205	19,5	60,0	2150	1
0270 8010	1.1/2*	205	19,5	60,0	2150	1
0270 8011	1.9/16*	230	20,0	66,0	2150	1
0270 8012	1.5/8*	225	20,5	66,0	2600	1
0270 8013	1.11/16*	225	20,5	66,0	2950	1
0270 8014	1.3/4*	225	20,5	66,0	2950	1
0270 8015	1.13/16*	240	22,5	75,0	2950	1
0270 8016	1.7/8*	240	22,5	75,0	2800	1
0270 8017	1.15/16*	255	24,0	80,0	3350	1

Art. Code	* AF	l mm	a mm	b mm	g	
0270 8018	2*	250	23,5	80,0	2800	1
0270 8019	2.1/16*	250	23,5	80,0	2800	1
0270 8020	2.1/8*	250	23,5	80,0	2800	1
0270 8021	2.3/16*	270	25,0	87,5	4000	1
0270 8022	2.1/4*	270	25,0	87,5	3800	1
0270 8023	2.5/16*	280	26,0	93,0	4000	1
0270 8024	2.3/8*	270	26,0	93,5	4000	1
0270 8025	2.7/16*	270	26,0	93,5	4000	1
0270 8028	2.5/8*	290	29,0	101,0	3850	1
0270 8030	2.3/4*	320	32,5	109,5	3850	1
0270 8032	2.7/8*	330	33,0	110,0	5700	1
0270 8048	3.7/8*	420	45,0	155,0	6500	1

* Made to order, no general stock size

MATADOR Heavy Duty Ring Spanners.

Long lever - large impact.

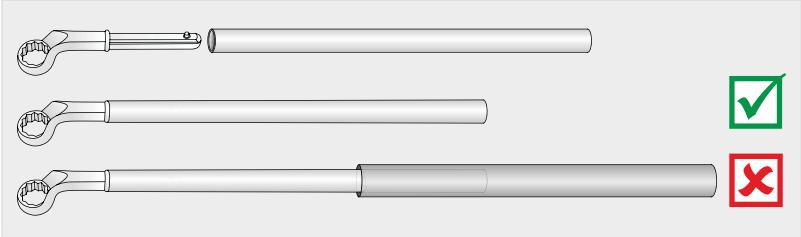
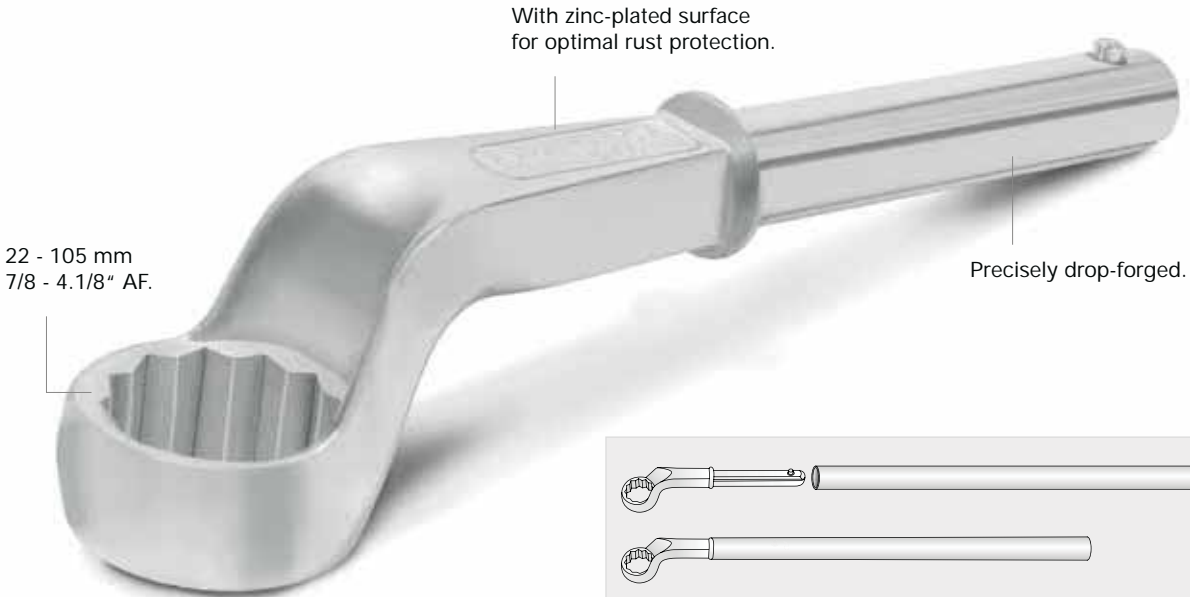

■ Heavy Duty Ring Spanners (MM)



- Tried and tested MATADOR classic
- For tightening and loosening of big screw joints, e.g. in heavy industry, shipbuilding, plant construction, etc.
- Precisely drop-forged
- Very high impact strength
- Very high power together with extension pipe
- With zinc-plated surface for durable rust protection

- Material: 31 CrV 3
- Surface: Matt chrome finish

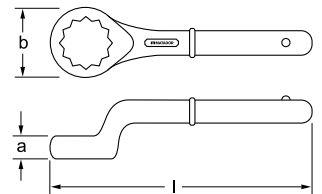

Art. Code	mm	l mm	a mm	b mm	g	
0280 0240	24	180	17,0	38,0	350	1
0280 0260	26*	190	17,0	42,0	430	1
0280 0270	27	190	17,4	42,0	400	1
0280 0300	30	200	18,4	47,0	450	1
0280 0320	32	235	18,4	50,0	550	1
0280 0330	33*	235	18,4	50,0	700	1
0280 0360	36	245	20,0	55,0	650	1
0280 0380	38	250	21,0	55,0	840	1
0280 0420	42*	265	22,0	61,5	1000	1
0280 0450	45*	280	23,0	68,5	1300	1
0280 0460	46	280	23,0	68,5	1050	1
0280 0480	48*	290	25,5	75,0	1450	1
0280 0500	50	290	25,5	75,0	1150	1
0280 0550	55	300	28,0	80,0	1400	1
0280 0600	60	345	30,5	89,0	2100	1

Art. Code	mm	l mm	a mm	b mm	g	
0280 0650	65	355	33,0	97,0	2300	1
0280 0700	70	365	35,5	104,0	2600	1
0280 0750	75	375	38,0	109,0	3000	1
0280 0800	80	385	40,5	124,0	3450	1
0280 0850	85	385	40,5	124,0	3800	1
0280 0900	90	410	45,0	140,0	4875	1
0280 0950	95	410	45,0	140,0	4565	1
0280 1050	105*	415	45,0	144,0	4600	1

* Made to order, no general stock size

The perfect leverage effect.

Long lever - large impact.

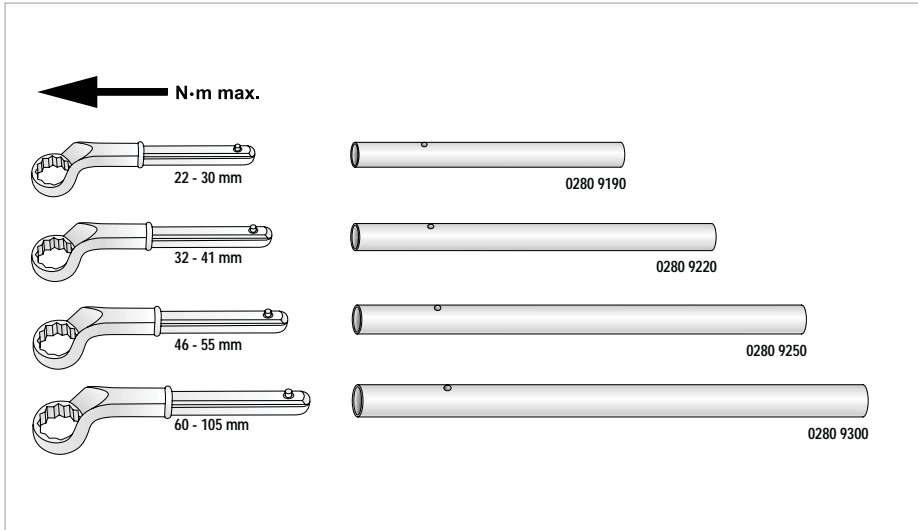

The perfect leverage effect.

Very convenient: The perfectly fitting extension pipes for MATADOR Heavy Duty Ring Spanners.

The increased lever transmission makes it possible to move big screws manually with relatively little effort. The locking pin allows quick assembly and disassembly.

Available in four sizes up to 105 mm. Special sizes on request.



Extension Pipes for Heavy Duty Ring Spanners

- For extension of the lever arm and increased force action
- With hole for safe locking and unlocking
- Material: 31 CrV 3
- Surface treatment: Zinc-plated

Art. Code	mm	mm	" AF	l mm	g	
0280 9190	19	22 - 30	7/8 - 1.3/16	460	600	1
0280 9220	22	32 - 41	1.1/4 - 1.11/16	610	1150	1
0280 9250	25	46 - 55	1.3/4 - 2.1/4	760	2150	1
0280 9300	30	60 - 105	2.3/8 - 4.1/8	860	2850	1



The specials from MATADOR.

For confined spaces and special applications.

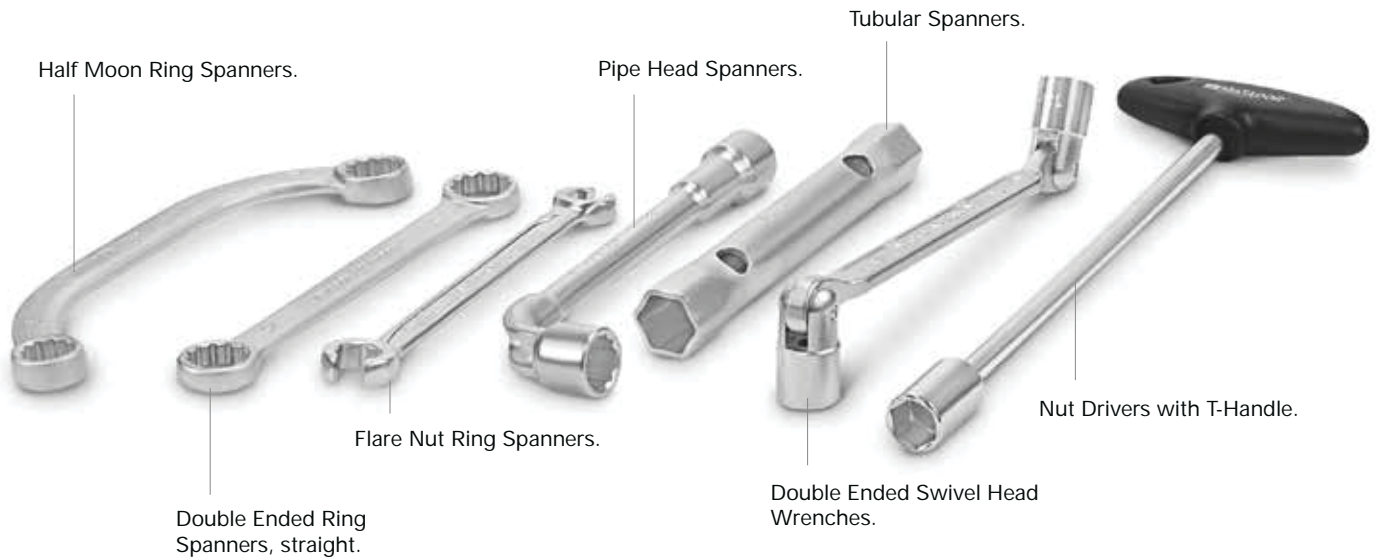

Half Moon Ring Spanners



- Double ended ring spanners with curved shaft and extra thin-walled rings for work in confined spaces (e. g. car engine block, carburettor / starter, electric generator etc.)
 - High-grade, durable industrial quality
 - Good grip thanks to matt chrome-plated surface, also with oily hands
- Material: Chrome Vanadium
 - Surface: Matt chrome finish

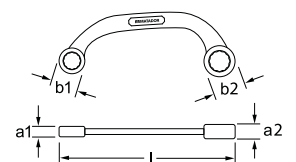
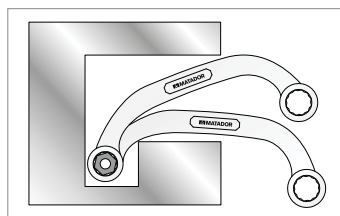

Art. Code	mm	l mm	a1 mm	a2 mm	b1 mm	b2 mm	g	
0188 1012	10 x 12	150	7,0	7,0	17,0	20,0	55	10
0188 1113	11 x 13	150	7,0	7,0	17,0	20,0	55	10
0188 1315	13 x 15	185	9,0	9,0	21,5	26,0	110	10
0188 1417	14 x 17	185	9,0	9,0	21,5	26,0	110	10
0188 1517	15 x 17	185	9,0	9,0	21,5	26,0	100	10
0188 1618	16 x 18	185	9,0	9,0	21,5	26,0	100	10
0188 1922	19 x 22	230	11,0	11,0	29,0	33,0	195	10

Double Ended Ring Spanners, straight

- Straight double ended ring spanners with extra-thin walled rings for work in confined spaces
- High-grade, durable industrial quality
- Good grip thanks to matt chrome-plated surface, also with oily hands
- Heads grinded fully automatically
- Standards: DIN 837 Form B ISO 3318 / 1085
- Material: Chrome Vanadium
- Surface: Matt chrome finish

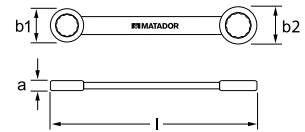

Art. Code	mm	l mm	a mm	b1 mm	b2 mm	g	
0220 0607	6 x 7	100	4,5	10,0	11,5	14	10
0220 0809	8 x 9	115	5,2	13,0	14,5	24	10
0220 0810	8 x 10	115	5,2	13,0	16,0	22	10
0220 1011	10 x 11	130	5,8	16,0	17,0	34	10
0220 1213	12 x 13	150	6,4	19,0	20,5	49	10
0220 1315	13 x 15	160	7,2	20,5	23,0	64	10
0220 1317	13 x 17	165	7,8	20,5	25,5	74	10
0220 1415	14 x 15	160	7,2	21,5	23,0	64	10
0220 1617	16 x 17	170	7,8	24,5	25,5	84	10
0220 1719	17 x 19	185	8,5	25,5	28,0	98	10
0220 1819	18 x 19	185	8,5	27,0	28,0	106	10
0220 2022	20 x 22	210	9,4	29,5	32,5	134	10
0220 2123	21 x 23	230	10,0	30,5	33,5	171	10
0220 2224	22 x 24	230	10,0	32,5	35,5	184	10
0220 2427	24 x 27	260	10,8	35,5	39,0	249	10
0220 2528	25 x 28	290	11,6	36,5	41,0	273	10
0220 3032	30 x 32	320	12,6	43,5	46,0	399	10



- Set in PP-Box

Art. Code	g
0220 9080 8 MM	430 1
Content: 0220 6 x 7 - 8 x 9 - 10 x 11 - 12 x 13 - 14 x 15 - 16 x 17 - 18 x 19 - 20 x 22 mm	
0220 9120 12 MM	1260 1
Content: 0220 6 x 7 - 8 x 9 - 10 x 11 - 12 x 13 - 14 x 15 - 16 x 17 - 18 x 19 - 20 x 22 - 21 x 23 - 24 x 27 - 25 x 28 - 30 x 32 mm	



Double Ended Ring Spanners, TORX®

- as above, but TORX® profile

Art. Code	E	l mm	a1 mm	a2 mm	b1 mm	b2 mm	g	
0221 0608	6 x 8	110	4,6	5,6	9,2	11,2	20	10
0221 1012	10 x 12	140	6,5	7,8	14,4	16,7	31	10
0221 1418	14 x 18	180	8,2	9,8	17,2	21,2	75	10
0221 2024	20 x 24	225	11,0	13,0	24,8	28,7	158	10
0222 1012	10 x 12 angled	140	6,5	7,8	14,4	16,7	31	10

- Set in carton box

Art. Code	g
0221 9080 4 MM	430 1
Content: 0221 6 x 8 - 10 x 12 - 14 x 18 - 20 x 24 mm	



■ Flare Nut Ring Spanners, open



- For cap nuts at pipelines, ideal for brake lines
 - Drop-forged with reinforced ring
 - Jaws slotted and 15° offset from shaft
 - Up to size 13 x 14 mm with hexagon profile, from size 14 x 17 mm with double hexagon profile
- Standards: DIN 3118
 - Material: Chrome Vanadium
 - Surface: Matt chrome finish

Art. Code	mm	l mm	t1 mm	t2 mm	a1 mm	a2 mm	b1 mm	b2 mm	g
0251 0810	8 x 10	145	6,0	7,0	7,0	8,5	18,0	20,0	47
0251 1011	10 x 11	152	7,0	8,5	8,5	9,0	20,0	22,0	60
0251 1012	10 x 12	152	7,0	9,0	8,5	9,0	20,0	22,6	60
0251 1113	11 x 13	165	8,5	10,0	9,0	10,5	22,0	25,0	78
0251 1314	13 x 14	178	10,0	11,0	9,5	11,0	24,0	27,4	120
0251 1417	14 x 17	196	11,0	14,0	11,0	12,0	27,4	30,0	145
0251 1719	17 x 19	210	14,0	15,0	12,0	14,0	30,0	32,5	180
0251 1922	19 x 22	233	15,0	17,0	14,0	16,0	32,5	38,0	240
0251 2224	22 x 24	252	17,0	18,0	16,0	17,0	38,0	41,0	300
0251 2427	24 x 27	265	18,0	20,0	17,0	18,0	41,0	45,0	350
0251 2736	27 x 36	285	20,0	22,0	18,0	25,0	45,0	58,0	470
0251 3032	30 x 32	285	22,0	24,0	21,0	23,0	48,5	51,0	470
0251 3641	36 x 41	350	27,0	32,0	25,0	27,0	58,0	65,0	820

- Tried and tested assortment of open flare nut ring spanners
- All important sizes in one set
- Set in practical, transparent polypropylene box: robust packaging, stackable and easy to stock, reclosable, reusable and with hanging hole for tool panels

Art. Code	g
0251 9050 5 MM	550

Content 8 x 10 - 10 x 12 - 11 x 13 - 14 x 17 - 19 x 22 mm

■ Flare Nut Ring Spanners, open



- Straight, reinforced type, especially for screwed connections on brake lines
- Straight slotted, with hexagon ring
- Material: Chrome Vanadium
- Surface: Matt chrome finish

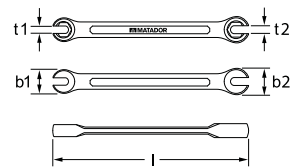

Art. Code	mm	l mm	t1 mm	t2 mm	b1 mm	b2 mm	g
0250 0001	10 x 11	150	7,0	8,5	20,5	22,3	170

- Offset, reinforced type, especially for screwed connections on brake lines
- Straight slotted, with hexagon ring
- Material: Chrome Vanadium
- Surface: Matt chrome finish

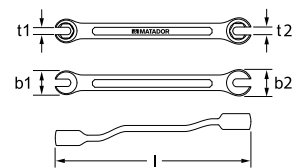

Art. Code	mm	l mm	t1 mm	t2 mm	b1 mm	b2 mm	g
0250 0002	10 x 11	150	7,0	8,5	20,5	22,3	170



Tubular Box Spanners

- For numerous fields of application, ideal for stud bolts, deep-set nuts and spark plugs
- With hollow shaft
- With borehole for tommy bars (Art. Code 342)
- Standards: DIN 896 Form B
ISO 2236 / 1085

- Material: C35 hardened
- Surface: Matt chrome finish

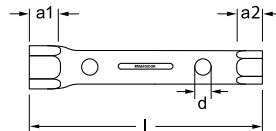

Art. Code	mm	d mm	l mm	a1 mm	a2 mm	g
0380 0607	6 x 7	5	105	6,0	6,5	80
0380 0809	8 x 9	6	105	7,0	7,5	85
0380 0810	8 x 10	6	120	7,0	8,0	105
0380 1011	10 x 11	6	140	8,0	8,5	115
0380 1213	12 x 13	8	140	9,5	10,0	145
0380 1315	13 x 15	8	140	10,0	11,5	170
0380 1415	14 x 15	8	140	10,5	11,5	185
0380 1617	16 x 17	10	150	12,0	12,5	215
0380 1719	17 x 19	12	155	12,5	15,5	240
0380 1819	18 x 19	12	155	13,5	15,5	275
0380 1821	18 x 21	12	155	13,5	16,0	345
0380 2022	20 x 22	12	165	16,0	16,5	385
0380 2123	21 x 23	14	165	16,0	18,0	490
0380 2427	24 x 27	14	180	20,0	22,0	550
0380 2528	25 x 28	16	195	20,0	22,0	550
0380 3032	30 x 32	16	195	23,0	27,0	715
0380 3236	32 x 36	18	215	27,0	28,0	750
0380 3641	36 x 41	18	215	28,0	31,0	885
0380 4146	41 x 46	20	235	31,0	35,0	890
0380 4650	46 x 50	20	235	35,0	37,0	890

- Tried and tested assortments of tubular box spanners
- All important sizes in one set
- In carton box



Art. Code	Content	g
0380 9080	0380 6 x 7 - 8 x 9 - 10 x 11 - 12 x 13 - 14 x 15 - 16 x 17 - 18 x 19 - 20 x 22 mm	850
0380 9120	0380 6 x 7 - 8 x 9 - 10 x 11 - 12 x 13 - 14 x 15 - 16 x 17 - 18 x 19 - 20 x 22 - 21 x 23 - 24 x 27 - 25 x 28 - 30 x 32 mm	2100

Tommy Bar

- 5 steps tommy bar for pipe head spanners (Art. Code 320), tubular box spanners (Art. Code 380) etc.
- For boreholes with a diameter of 5, 6, 8, 10 and 12 mm
- Suitable as T-handle

- Material: Chrome Vanadium
- Surface: Matt chrome finish

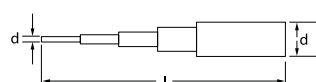

Art. Code	d mm	l mm	g
0342 0250	5 - 6 - 8 - 10 - 12	200	230

Hexagon Nut Drivers



- With 2-component handle with hard zone for quick fastening and soft zone for comfortable fine adjustment
- Especially ergonomic handle
- With hanging hole

- Standards: DIN 3125
- Blade Material: Chrome Vanadium
- Blade Surface: Matt chrome finish

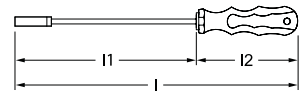

Art. Code	mm	M	l mm	l1 mm	l2 mm	g	
0670 2050	5	2,5	235	125	110	67	10
0670 2060	6	3,5	235	125	110	69	10
0670 2070	7	4,0	235	125	110	100	10
0670 2080	8	5,0	235	125	110	102	10
0670 2100	10	6,0	235	125	110	106	10

Hexagon Nut Drivers, flexible



- With flexible shaft
- For hose clamps and confined spaces
- With 2-component handle with hard zone for quick fastening and soft zone for comfortable fine adjustment
- Especially ergonomic handle
- With hanging hole

- Standards: DIN 3125
- Blade Material: Chrome Vanadium
- Blade Surface: Matt chrome finish

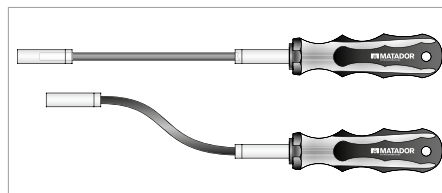

Art. Code	mm	M	l mm	l1 mm	l2 mm	g	
0670 0050	5	2,5	410	150	260	129	10
0670 0060	6	3,5	410	150	260	131	10
0670 0070	7	4	410	150	260	132	10
0670 0080	8	5	410	150	260	133	10
0670 0100	10	6	410	150	260	140	10

Nut Drivers with T-Handle

- Extra long design
- With ergonomically designed T-handle made of highly impact-resistant special plastic
- With hanging hole
- Chamfered edges
- Blade Material: Chrome Vanadium
- Blade Surface: Nickel-plated

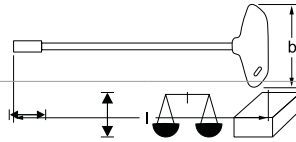

Art. Code	mm	M	l mm	b mm	g	
0671 0055	5,5	3	230	90	123	10
0671 0060	6	3,5	230	90	125	10
0671 0070	7	4	230	90	125	10
0671 0080	8	5	230	90	138	10
0671 0090	9		230	90	140	10
0671 0100	10	6	230	90	172	10
0671 0110	11	7	230	90	170	10
0671 0120	12	(8)	230	90	174	10
0671 0130	13	8	230	90	177	10
0671 0140	14		230	90	185	10



Wheel Nut Wrenches

- With deep head for deep-set wheel nuts
- Hardness and torque values as per DIN 899
- Especially high corrosion resistance thanks to KTL coating (cathaphoretic dip paint)
- Material: Chrome Vanadium
- Surface: KTL coating

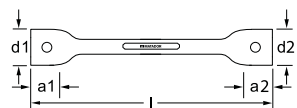

Art. Code	mm	AF	mm	l mm	a1 mm	a2 mm	d1 mm	d2 mm	g
0340 2427	24 x 27	15/16 x 1.1/16	18	400	34,5	34,5	37	41	80
0340 2730	27 x 30	1.1/16 x 1.3/16	18	400	34,5	34,5	41	45	85
0340 2732	27 x 32	1.1/16 x 1.1/4	18	400	34,5	34,5	41	47	105
0340 2833	28 x 33		18	400	34,5	34,5	42	48	115
0340 3032	30 x 32	1.3/16 x 1.1/4	18	400	34,5	34,5	45	47	145
0340 3233	32 x 33		18	400	34,5	34,5	47	48	170



Tommy Bar

- Straight tommy bar
- Surface: KTL coating

Art. Code	mm	l mm	g
0342 0600	18	600	1190

